

# Wireless Sensor Network

## Third European Workshop, EWSN 2006 Zurich, Switzerland, February 2006, Adjunct Proceedings

**Edited Volume****Author(s):**

Römer, Kay; Karl, Holger; Mattern, Friedemann

**Publication date:**

2006

**Permanent link:**

<https://doi.org/10.3929/ethz-a-006788315>

**Rights / license:**

In Copyright - Non-Commercial Use Permitted

**Originally published in:**

Technischer Bericht / Departement Informatik, ETH Zürich 507

Kay Römer  
Holger Karl  
Friedemann Mattern (Eds.)

# Wireless Sensor Network

Third European Workshop, EWSN 2006  
Zurich, Switzerland, February 2006  
Adjunct Proceedings

Technical Report TR 507  
Department of Computer Science, ETH Zurich



Eidgenössische Technische Hochschule Zürich  
Swiss Federal Institute of Technology Zurich



## Preface

This volume contains the adjunct proceedings of EWSN 2006, the third in a series of European workshops on wireless sensor networks. The workshop took place at ETH Zurich from February 13 to 15, 2006. Its objective was to present, discuss, and explore the latest technical developments in the field of wireless sensor networks, as well as potential future directions.

Wireless sensor networks provide a bridge between traditional information systems and the physical world, with collections of wirelessly networked sensor nodes being deployed in our physical environment to cooperatively monitor real-world phenomena, but also to control aspects of the physical world. In contrast to traditional computing systems which are mostly decoupled from the real world, wireless sensor networks are inherently and closely integrated with the real world, with data about the physical environment being captured and processed automatically, online, and in real time. This paradigmatic change comes with a number of conceptual and technical challenges involving a wide range of disciplines in computer science and electrical engineering, but also material sciences, MEMS technology, and power engineering; thus making wireless sensor networks a multidisciplinary area of research. This workshop series aims at providing a high-level scientific forum to implement the cross-disciplinary exchange of ideas and results that is essential for this type of research area.

In addition to the demonstration and poster abstracts, this volume also contains the winning submissions of the Sentient Future Competitions and a set of highly commended submissions to this competition. The winners of the competition were awarded during a special session at EWSN 2006. Furthermore, the conference program included a full paper track (published as Springer LNCS volume 3868), and a special session on European research initiatives focusing on wireless sensor networks. Karl Aberer (EPFL), director of the Swiss National Competence Centre in Research for Mobile Information and Communication Systems (NCCR-MICS), delivered a keynote talk entitled “Unleashing the Power of Wireless Networks through Information Sharing in the Sensor Internet.” Moreover, the workshop offered two half-day tutorials:

- Data Management in Sensor Networks (Samuel Madden, MIT)
- Algorithms for Wireless Sensor Networks (Roger Wattenhofer, ETH Zurich)

In closing, we would like to express our sincere appreciation to all authors who submitted papers. We deeply thank all members of the program committee and the external reviewers for their time and effort as well as their valuable input. Finally, we would like to thank our sponsoring institutions and the Organizing Committee.

February 2006

Kay Römer and Holger Karl, Program Chairs  
Friedemann Mattern, General Chair



# Organization

EWSN 2006, the third in a series of European workshops on wireless sensor networks, took place in Zurich, Switzerland from February 13 to 15, 2006. It was organized by ETH Zurich, the Swiss Federal Institute of Technology.

## Executive Committee

General Chair: Friedemann Mattern (ETH Zurich, Switzerland)  
Program Co-chairs: Kay Römer (ETH Zurich, Switzerland) and  
Holger Karl (University of Paderborn, Germany)  
Publicity Co-chairs: Nirupama Bulusu (Portland State University, USA) and  
Thiemo Voigt (SICS, Sweden)

## Organizing Committee

Christian Frank (ETH Zurich, Switzerland)  
Marc Langheinrich (ETH Zurich, Switzerland)  
Matthias Ringwald (ETH Zurich, Switzerland)  
Kay Römer (ETH Zurich, Switzerland) (Chair)  
Silvia Santini (ETH Zurich, Switzerland)

## Program Committee

Ozgur Akan (Middle East Technical University, Turkey)  
Michel Banâtre (INRIA, France)  
Christian Bettstetter (University of Klagenfurt, Austria)  
Nirupama Bulusu (Portland State University, USA)  
Srdjan Capkun (Technical University of Denmark, Denmark)  
Erdal Cayirci (Istanbul Technical University, Turkey)  
George Coulouris (Cambridge University, UK)  
Jean-Pierre Ebert (IHP Microelectronics, Germany)  
Eylem Ekici (Ohio State University, USA)  
Jeremy Elson (Microsoft Research, USA)  
Paul J. M. Havinga (University of Twente, The Netherlands)  
Wendi Heinzelman (University of Rochester, USA)  
Holger Karl (University of Paderborn, Germany)  
Bhaskar Krishnamachari (University of Southern California, USA)  
Koen Langendoen (TU Delft, The Netherlands)  
Pedro J. Marrón (University of Stuttgart, Germany)  
Friedemann Mattern (ETH Zurich, Switzerland)  
Amy L. Murphy (University of Lugano, Switzerland)  
Chiara Petrioli (University “La Sapienza” Rome, Italy)  
Bart van Poucke (IMEC, Belgium)

Hartmut Ritter (FU Berlin, Germany)  
Kay Römer (ETH Zurich, Switzerland)  
Lothar Thiele (ETH Zurich, Switzerland)  
Thiemo Voigt (SICS, Sweden)  
Matt Welsh (Harvard University, USA)  
Dirk Westhoff (NEC, Germany)  
Andreas Willig (TU Berlin, Germany)  
Adam Wolisz (TU Berlin, Germany)

### **Supporting Institutions**

Embedded Wisents Project (EU FP6-IST Coordination Action)  
ETH Zurich, Switzerland

# Table of Contents

## Poster Abstracts

Bayesian Localization in Randomized Wireless Sensor Networks . . . . .	2
<i>Henrik Schiøler, Martin B. Hansen, Hans Peter Schwefel</i>	
An Embedded GPRS Gateway for Environmental Monitoring Wireless Sensor Networks . . . . .	4
<i>Francesco Chiti, Michele Ciabatti, Giovanni Collodi, Davide Di Palma, Antonio Manes</i>	
Pilot Experiment of an Early Warning Fire Detection System . . . . .	6
<i>Gil Manuel Gonçalves, Alexandre Sousa, José Pinto, Paulo Lebres, João Sousa</i>	
Sensor Fusion in Multirobot Workcell Using Sensor Networks . . . . .	8
<i>Mikko Sallinen, Tapio Heikkilä</i>	
Power-Efficient Distributed Support Vector Machines for Wireless Sensor Networks . . . . .	10
<i>K. Flouri, B. Beferull-Lozano, P. Tsakalides</i>	
A Theoretical Analysis of Routing Protocols in Wireless Sensor Networks . . . .	12
<i>Juan José Vinagre, Antonio J. Caamaño, Javier Ramos, Eduardo Morgado Reyes</i>	
Wireless Sensor Networks in Agricultural Applications (Field Studies) . . . . .	14
<i>Alexander Coers, Markus Holzappel, Hans-Christian Müller</i>	
Introducing Logical Neighborhoods for Programming Wireless Sensor and Actor Networks . . . . .	16
<i>Luca Mottola, Gian Pietro Picco</i>	
Efficient Decision Fusion with Performance Guarantees in Sensor Networks . . .	18
<i>Zinaida Benenson, Gernot Fabeck</i>	
A Lifetime-Efficient Forwarding Strategy for Wireless Sensor Networks . . . . .	20
<i>Marcel Busse, Thomas Haenselmann, Wolfgang Effelsberg</i>	
Modular Communication Protocols for Sensor Networks . . . . .	22
<i>Olaf Landsiedel, Jó Ágila Bitsch, Katharina Denking, Klaus Wehrle</i>	
Monitoring Indoor Temperature and Humidity for Pig Stables . . . . .	24
<i>Jens A. Hansen, Thomas D. Nielsen, Henrik Schiøler</i>	
A PIR based wireless sensor node prototype for surveillance applications . . . . .	26
<i>Piero Zappi, Elisabetta Farella, Luca Benini</i>	



Sensor Networks for Corrosion Monitoring . . . . .	28
<i>Adrian Hozoi, Zoltan Papp, Peter van der Mark</i>	
Security and Advanced Control Issues in a Robotic Platform for Monitoring and Relief . . . . .	30
<i>Antonio Danesi, Ida M. Savino, Riccardo Schiavi, Antonio Bicchi, Gianluca Dini</i>	
Experimental Localization Results in an Indoor Wireless Sensor Network Testbed . . . . .	32
<i>Sebastiaan Blom, Matteo Andretto, Andrea Zanella, Michele Zorzi, Simone Friso, Riccardo Crepaldi</i>	
A Complete Energy Model for Wireless Sensor Networks . . . . .	34
<i>Lasse Öberg, Youzhi Xu</i>	
Receiver Oriented Trajectory Based Forwarding . . . . .	36
<i>A. Capone, M. Cesana, I. Filippini, L. Fratta, L. Pizziniaco</i>	
Architecture of a scalable wireless sensor network for pollution monitoring . . .	38
<i>Karl Baumgartner, Stephan Robert</i>	
Energy Efficient Area Coverage in Arbitrary Sensor Networks . . . . .	40
<i>Markos Sigalas, George Vouros</i>	
Toward Adaptive Wireless Sensor Networks . . . . .	42
<i>Silvia Santini</i>	
Interfacing the Real World with Ubiquitous Gateways . . . . .	44
<i>Christian Frank, Christoph Roduner, Chie Noda, Marco Sgroi, Wolfgang Kellerer</i>	
<b>Demonstration Abstracts</b>	
Concealed Data Aggregation for WSNs . . . . .	48
<i>Joao Girao, Dirk Westhoff</i>	
Low-Power Multihop Sensor Networking using WiseMAC . . . . .	50
<i>Amre El-Hoiydi, Jean-Dominique Decotignie</i>	
Building Adaptable Sensor Networks with Sensor Cubes . . . . .	52
<i>H. Diall, K. Raja, I. Daskalopoulos, S. Hailes, T. Torfs, C. Van Hoof, G. Roussos</i>	
Energy Management in Buildings with Sensor Networks . . . . .	54
<i>David Garcés, Albert Krohn, Odilo Schoch</i>	
NemoTrack: A RF-Based Robot Tracking System in Wireless Sensor Networks . . . . .	56
<i>Xingfa Shen, Hongbin Li, Jun Zhao, Jiming Chen, Zhi Wang, Youxian Sun</i>	
Sensor Network Maintenance Toolkit . . . . .	58
<i>Jan Beutel, Matthias Dyer, Kevin Martin</i>	

BASUMA - A Body Sensor System for Telemedicine . . . . .	60
<i>J.-P. Ebert, D. Dietterle, M. Lang, T. Falck, J. Espina, Frieder Scheller, Günther Uhrich</i>	
Interactive In-Field Inspection of WSNs . . . . .	62
<i>Matthias Ringwald, Mustafa Yücel, Kay Römer</i>	
<b>Sentient Future Competition: Winners</b>	
Introduction . . . . .	66
<i>George Coulouris, Marcelo Pias, Irina Pien</i>	
Large Scale Body Sensing for Infectious Disease Control . . . . .	68
<i>Markus Endler</i>	
BIN IT! - The Intelligent Waste Management System . . . . .	71
<i>David Schoch, Matthias Sala</i>	
Vision of Congestion-Free Road Traffic and Cooperating Objects . . . . .	74
<i>Ricardo Morla</i>	
<b>Sentient Future Competition: Highly Commended Entries</b>	
Ambient Intelligence by Collaborative Eye Tracking . . . . .	80
<i>Eiko Yoneki</i>	
A day in the life of a not too distant future . . . . .	84
<i>Phillip R. De Caux</i>	
Embedded WiSeNts & Agnostic Algorithms of Creation . . . . .	86
<i>Panagiotis Bairaktaris</i>	
Father in Womb . . . . .	90
<i>T. Camilo, A. Rodrigues, J. Sá Silva, F. Boavida, E. Sá</i>	
LocuSent - large scale locust control system . . . . .	92
<i>Milo Lavén</i>	
PerSens: Personality Sensors . . . . .	96
<i>Zinaida Benenson, Mesut Güneş, Marin Wenig</i>	
Sentient Guardian Angel . . . . .	98
<i>Marcus Christ, Gerald Eichler, Klaus Mieth, Stefanie Richter, Jens Schmidt, Jens Wukasch</i>	
<b>Author Index</b> . . . . .	101



## Poster Abstracts

# Poster Abstract: Bayesian Localization in Randomized Wireless Sensor Networks

Henrik Schioler  
CISS(Centre for Embedded  
Software Systems) Aalborg  
University  
Aalborg, Denmark  
henrik@control.aau.dk

Martin B. Hansen  
Dept. for Math. Sciences  
Aalborg University  
Aalborg, Denmark  
mbh@math.aau.dk

Hans Peter Schwefel  
Dept. for Communication  
Aalborg University  
Aalborg, Denmark  
hps@kom.aau.dk

## Keywords

localization, wireless sensor networks, probabilistic modelling

## 1. INTRODUCTION

Localization of units in wireless sensor networks is of major importance in many applications, such as environmental monitoring, health monitoring in livestock as well as battle field scouts for military use. Due to cost limitations only a few units may be equipped with GPS capabilities, which calls for other approaches e.g. based on information from the network communication. Such approaches roughly fall in two categories; time based methods and methods based on received signal strength (RSS). In this paper we investigate a time based method for multi hop wireless networks, where transmission delay comprises the time from when the message was originally generated until it after several relays in the network is received at an access point.

## 2. NETWORK MODELING

We consider randomized broadcasting networks where messages are flooded randomly throughout the entire network, and where information propagation resembles rumor and epidemic disease spreading in complex sociologic networks. In [3] a model for a spatial continuum is developed for communication in wireless mobile ad-hoc networks. The derived model accounts for radio coverage, message discard and unit mobility. We assume a randomized broadcasting transmission discipline, where messages are stored for a random period of time and broadcasted randomly according to a Poisson process until discarded from memory as described in further detail in [3]. We denote by  $\lambda$  and  $\alpha$  transmission and discard rates respectively.

### 2.1 Node distribution and mobility

A model of node distribution should account for both deterministic deployment and random distribution. We assign to each node  $i$  the time dependent probability measure  $L_i$  of location, i.e.  $L_i(A, t)$  expresses the probability that node  $i$ , at time  $t$ , is located within the subset  $A$  of the overall domain  $D$ . Adding up for the entire set of nodes yields the additive positive measure  $L$ , i.e.

$$L(A, t) = \sum_i L_i(A, t) \quad (1)$$

where  $L(A, t)$  expresses the expected number of nodes within  $A$  at time  $t$ . Several models accounting for node mobility

exist. In this work we consider the case of Brownian motion [7].

For an initial location measure  $L_i(\cdot, 0)$ , Brownian motion generally transforms the location measure as follows

$$L_i(A, t) = \int_A \int_D \mathcal{N}(y, x, vt) L_i(dy, 0) dx \quad (2)$$

where  $\mathcal{N}(\cdot, x, vt)$  is the normal density with mean  $x$  and variance  $vt$ .

### 2.2 Information Propagation

We denote by  $f(x, t)$  the conditional probability that a generic node located at  $x$  holds  $M$  at time  $t$ . Similarly let  $g(x, t)$  denote the conditional probability that a generic node located at  $x$ , discarded  $M$  previous to  $t$ . For uniform location measures an overall model for information propagation is given in the shape of the integro-differential equations in 3.

$$\frac{d}{dt} f(x, t) = -\alpha f(x, t) + (1 - f(x, t) - g(x, t)) \cdot \quad (3)$$

$$\lambda \rho \int_D K(x, \eta) [f(\eta, t) + e^{\alpha t} \mathcal{N}(\eta, x_g, vt)] d\eta + \rho v \operatorname{tr} f_{xx}(x, t)$$

$$\frac{d}{dt} g(x, t) = \alpha f(x, t) + \rho v \operatorname{tr} g_{xx}(x, t)$$

where  $\rho$  is the node density in  $D$  and  $\operatorname{tr} f_{xx}$  and  $\operatorname{tr} g_{xx}$  denote the trace of the Hessians  $f_{xx}$  and  $g_{xx}$  respectively. The associated terms are so called *diffusion* terms accounting for information propagation and discard through Brownian motion. In 3 the term  $e^{\alpha t} \mathcal{N}(\eta, x_g, vt)$  accounts for  $M$  initially generated at  $x_g$  still actively residing in its origin node. Access points resemble sensor units in terms of information propagation except from the fact, that they neither relay nor discard messages. Access point reception dynamics then become

$$\frac{d}{dt} R_{x, y_i}(t - \tau) = (1 - R_{x, y_i}(t - \tau)) \cdot \quad (4)$$

$$\lambda \rho \int_D K(y_i, \eta) [f(\eta, t - \tau) + e^{\alpha(t-\tau)} \mathcal{N}(\eta, x, v(t-\tau))] d\eta$$

where  $R_{x, y_i}(t - \tau)$  denotes the conditional probability that  $M$  is received at an access point located in  $y_i$  before time  $t$  given  $M$  was generated at a location  $x$  at time  $\tau$ .

## 3. LOCALIZATION

A transient compound model is given in terms of the integro-differential equation 3 and 4 as well as 2 tracking the time

dependent distribution of mobile nodes. Reception time densities and reception probabilities may serve as the basis for the estimation of  $x_g$ , i.e. localization of the unit  $j$  generating  $M$  as well as for estimating the message generation time  $\tau$ . One applicable strategy would record the times  $\{t_{i,j,n}\}$  where the  $n$  th. message  $M_{n,j}$  generated in  $j$  was received at access point  $i$ , subsequent to the time  $t_{n,j}^*$ , where  $M_{n,j}$  was first received at a station among all access points. At time  $t_{n,j}^* + T$  a Bayesian estimate is given by

$$\begin{aligned} (\tau_{n,j}^*, x_{n,j}^*) = & \quad (5) \\ \arg \max_{x,\tau} p_{n,j}(\tau) \cdot \prod_{i \in R_T(n,j)} r_{x,y_i}(t_{i,j,n} - \tau) \cdot & \\ \prod_{i \notin R_T(n,j)} (1 - r_{x,y_i}(t_{n,j}^* + T - \tau)) & \end{aligned}$$

where  $r_{x,y_i}$  is the density function associated to  $R_{x,y_i}$ ,  $p_{n,j}$  is an a priori generation time density,  $\tau_{n,j}^*$  estimates the generation time of  $M_{n,j}$  and  $x_{n,j}^*$  estimates the position  $x_{n,j}$  of  $j$  at  $\tau_{n,j}$ . In 5  $R_T(n,j)$  denotes the subset of access points for which  $M_{n,j}$  is received within  $[t_{n,j}^*, t_{n,j}^* + T]$ . In this way the estimator takes into account that a message  $M_{n,j}$  does not reach all stations within the estimation horizon  $t_{n,j}^* + T$ . For the estimator 5 propagation times  $\{t_{i,j,n} - \tau_{n,j}\}$  are assumed conditionally independent given the message generation location  $x_{n,j}$ .

### 3.1 Recursive Estimation

A recursive estimator would take into account the entire reception time history and relate it to a node mobility model. In this paper we adopt the Kalman filter approach [8] to combine measurement history and mobility dynamics. Since Brownian motion is assumed on a two dimensional surface 6 provides a state model for motion dynamics

$$\begin{aligned} x_{n+1,j} &= x_{n,j} + w_n \sqrt{v(\tau_{n+1,j} - \tau_{n,j})} & (6) \\ x_{n,j}^* &= x_{n,j} + \nu_n \end{aligned}$$

where  $\{w_n\}$  and  $\{\nu_n\}$  are stationary Gaussian innovations and measurement noise respectively. Estimating  $x_{n,j}$  from the measurement sequence  $\{x_{n,j}^*\}$  is performed through the Kalman filter 7

$$\hat{x}_{n+1,j} = \hat{x}_{n,j} + L_n(x_{n,j}^* - \hat{x}_{n,j}) \quad (7)$$

where  $\hat{x}_{n,j}$  provides the estimate of  $x_{n,j}$  and  $L_n$  is the so called Kalman gain [8].

## 4. EXPERIMENTAL SETUP AND RESULTS

We consider a two dimensional spatial domain  $D$  in shape of the unit square, i.e.  $D = [0, 1]^2$ , where 100 nodes are initially uniformly distributed in  $D$ .  $D$  is equipped with 4 access points located in corners  $\{(0, 0), (0, 1), (1, 0), (1, 1)\}$  In the presented setup a transmission range of 0.1 is used. Unit mobility is modelled as a Brownian motion with reflective boundaries and a constant speed  $v = 1e - 3$ . Numerical results for  $f$  are shown in figure 1 for a generation point 0.4, 0.4, both for times  $t = 0.5$ .

Figure 2 show results when the estimator 5 and the Kalman filter 7 is applied to the above data. The estimation error is dominated by a quantization effect introduced by evaluating  $R_{x,y_i}$  only at gridpoints  $\{(n \cdot 0.2, m \cdot 0.2)\}$ .

## 5. REFERENCES

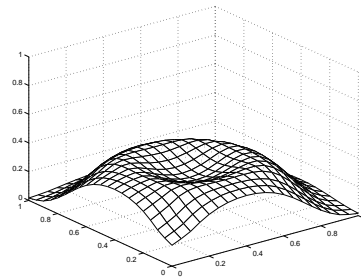

Figure 1: Time slice for  $f$  at time  $t = 0.5$  for a message generation point  $(0.4, 0.4)$ .

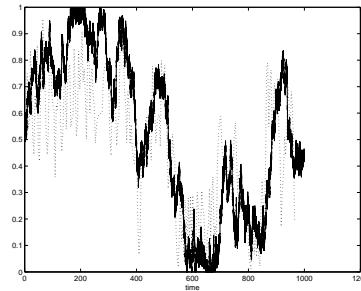

Figure 2: Position estimates for mobile node with Kalman filtering

- [1] Dharma P. Argrawal and Carlos de Morais Cordeiro. *Mobile ad hoc networking*. Technical report, OBR Research Center for Distributed and Mobile Computing, ECECS University of Cincinnati
- [2] A. Cerpa and D. Estrin, *Adaptive Self-Configuring Sensor Network Topologies*, UCLA CS, Dept. Tech. Report UCLA/CSD-TR-01-0009, May 2001
- [3] H. Schioler M. Hansen, H. Schwefel *Probabilistic Modelling of Information Propagation in Wireless Mobile Ad-Hoc Networks*, , WPMC05, Sept. 05, Aalborg, Denmark
- [4] Y. Moreno, M. Nekovee, A. F. Pacheco, *Dynamics of rumor spreading in complex networks*. Phys. Rev. E, 69, 066130 (2004).
- [5] J. Medlock and M. Kok, *Spreading disease: integro-differential equations old and new*. Mathematical Biosciences, 184, 201-222, 2004
- [6] B. K. Øksendal, *Stochastic Differential Equations. An Introduction with Applications*, Springer Verlag, 2000
- [7] R. Groenevelt, E. Altman, and P. Nain, *Relaying in mobile ad hoc networks*, In Proc. of Workshop on Modeling and Optimization in Mobile, Ad Hoc and Wireless Networks (WiOpt'04), UK, March 2004.
- [8] K. Shanmugan, A. Breipohl, *Random Signals - Detection, Estimation and Data Analysis*, Wiley, 1988

# Poster Abstract:

## An Embedded GPRS Gateway for Environmental Monitoring Wireless Sensor Networks

Francesco Chiti<sup>1</sup>, Michele Ciabatti<sup>1</sup>, Giovanni Collodi<sup>1</sup>, Davide Di Palma<sup>1</sup>,  
University of Florence,

<sup>1</sup>Department of Electronics and Telecommunications,  
via di S. Marta 3, 50139 Florence,  
+390554796467

chiti@lart.det.unifi.it

collodi@ing.unifi.it

{michele.ciabatti, davide.dipalma}@unifi.it

Antonio Manes<sup>2</sup>  
University of Florence,

<sup>2</sup>Department of Energetic  
via di S. Marta 3, 50139 Florence,  
+390553434282

antonio.manes@unifi.it

### ABSTRACT

This paper deals with the design and realization of an embedded GPRS gateway for Wireless Sensor Networks (WSN), with particular regard to the requirements and targets of the FP6 EU Integrated Project "GoodFood"[1]. In particular, the project's Work Package 7 (WP7) has deployed a pilot site in the Montepaldi Farm (Tuscany, Italy) for the exploitation of Ambient Intelligence (AmI) paradigms in the wine production phase monitoring.

In this context, the developed gateway provides a continuous bi-directional connectivity for the deployed WSN, encapsulating data and service messages in a custom data format. The gateway acts as a TCP client and it is permanently connected to a Central Management System (CMS), devoted to populate a database with the sensing data gathered from the WSN sensors, and to provide both a real-time low level log interface and a high level graphical user interface.

### Keywords

Wireless Sensor Networks, Gateway, TCP/IP based connection, GPRS.

## 1. SYSTEM DESIGN

### 1.1 REQUIREMENTS

The analysis of both the user's needs and the requirements of the specific deployment scenario led to develop a stand-alone gateway, capable to provide a real time, wide-area wireless interface for each WSN to be installed in the WP7 test sites (Montepaldi vineyards and additional locations).

The device was expected to be self powered, in order to face real on field installation, where no power sources are commonly available; in addition, several communication procedures were requested to maximize the overall system reliability, and consequently to minimize on site maintenance operations.

### 1.2 IMPLEMENTATION ISSUES

The developed gateway features a miniaturized GSM/GPRS modem, with embedded TCP/IP stack [4],[5],[6],[7]. A powerful 50 MHz clock microcontroller is responsible to coordinate the bi-directional data exchange between the modem and the master node (actually, a standard MICA2 mote) and to handle the communication with the CMS. An additional 128 KB SRAM memory has been added, in order to allow for data buffering, even if the wide area link is lost. Several A/D channels are also available, for connecting additional analog sensors (i.e., meteorological sensors) and battery voltage monitor.

The firmware implementation of communication protocol focused on improving system reliability and facing wide area link failures. Since the gateway is always connected with the CMS, preliminary connectivity experiments demonstrated a number of possible inconveniences, most of them involving the Service Provider APN and GGSN subsystems. To face this drawbacks, custom procedures, called Dynamic Session Re-negotiation (DSR) and Forced Session Re-negotiation (FSR), have been implemented both on the gateway and on the CMS server. This led to a significant improvement in terms of disconnection periods and packets loss rate, as presented in the following section.

The DSR procedure consists in a periodical bi-directional control packet exchange, aimed at verifying on both sides (gateway and CMS) the status of uplink and downlink channels. This approach allows facing potential deadlocks in the case of asymmetric socket failure, that is, when one device (acting as client or server) can correctly deliver data packets on the TCP/IP connection but is unable to receive any. Once this event occurs (it has been observed during long GPRS client connections, and probably it is due to Service Provider's Access Point failures), the DSR procedure makes the client unit to restart the TCP socket connection with the CMS.

The FSR procedure, instead, is operated on server side when no data or service packets are received from a gateway unit, and a fixed timeout elapses: in this case, the CMS closes the TCP

socket with that unit and waits for a new reconnection. On the other side, the gateway unit should catch the *close* event exception and start a recovery procedure, after which a new connection is re-established. If the close event should not be signaled to the gateway (for example, the FSR procedure is started during an asymmetric socket failure), the gateway would anyway enter the DSR recovery procedure.

In any case, once the link is lost, the gateway unit tries to reconnect with the CMS until a connection is re-established.

## 2. RESULTS

Two gateway units have been deployed on field for the exploitation of GoodFood WP 7 demonstrating activities. The units have been released, with stable firmware version, in September 2005.

In particular, Gateway 01 was installed in a greenhouse, owned by University of Florence, for the exploitation of test case in a controlled environment, whilst Gateway 02 was deployed in October 2005 in the Montepaldi vineyard. This second device is supplied with a photovoltaic panel and a rechargeable high-capacity battery, thanks to its low current consumption, even if always connected to the CMS.

In a reference period of one week (anyway longer intervals appeared to provide corresponding results), the gateway unit deployed at Montepaldi Farm reported few disconnection events: the reason of each of them can be actually evaluated through remote data logging (a “Plug” message is sent after each reconnection, reporting in a status byte the reason of previous disconnection), and they are due both to DSR and FSR procedures.

The overall disconnection duration has been calculated equal to about 40 minutes in one week, thus leading to an efficiency of 99.6 %. A similar result can be claimed also for the unit deployed in the Greenhouse site.

Also including preliminary tests, a maximum disconnection interval of about one hour has been recorded (probably due to Service Provider’s equipment malfunction), thus confirming the goodness of the implemented procedures.

## 3. FURTHER ADVANCEMENTS

In the next phase of the GoodFood project, among many other research tasks, further advancements will also involve the development of the GPRS gateway unit.

A second hardware release is planned, aiming at minimizing power consumption performance for the photovoltaic panel supplied version. The implementation of stable low power RTC (Real Time Clock) could allow increasing again the efficiency, by buffering data packets even when the TCP/IP link is not available and applying to them a timestamp field.

In addition, a new design of the hardware connectors will permit to extend GPRS-to-WSN capabilities also to non-MICA2 platforms, and, in the meantime, to improve system miniaturization.

## 4. ACKNOWLEDGMENTS

The authors would like to express their gratitude to Prof. Gianfranco Manes for his fruitful comments and discussions. A particular thank the members of the EU Integrated Project FP6-IST-1-508774-IP “GoodFood” WorkPackage 7 for their supporting in this research.

## 5. REFERENCES

- [1] *GoodFood Project*. <http://www.goodfood-project.org>.
- [2] *TinyOS*. <http://www.tinyos.net>.
- [3] *MICA2 Series*. <http://www.xbow.com/Products>.
- [4] M. Sveda, P. Benes, R. Vrba, F. Zezulka, Introduction to Industrial Sensor Networking, in Handbook of Sensor Networks: Compact Wireless and Wired Sensing Systems. CRC Press, FL, 2005.
- [5] Jain, J.N. and Agrawala, A.K., *Open Systems Interconnection: Its Architecture and Protocols*. Elsevier, Amsterdam, 1990.
- [6] Sveda, M. and Vrba, R., *Actuator-sensor interface interconnectivity*. Control Eng. Pract., 7, 95, 1999.
- [7] Aagaard, M. et al., *Experiments in task scheduling and distribution among Bluetooth-enabled robots*. Tech. Rep. Aalborg University, Denmark, 2002.



# Poster Abstract: Pilot Experiment of an Early Warning Fire Detection System

Gil Manuel Gonçalves, Alexandre Sousa, José Pinto, Paulo Lebres, João Sousa  
Faculdade de Engenharia da Universidade do Porto  
Rua Dr. Roberto Frias  
Porto, Portugal  
+ 351 22 508 1539

{gil, ajsousa, zepinto, paulo.lebres, jtasso}@fe.up.pt

## 1. INTRODUCTION

The last decade has witnessed unprecedented interactions between technological developments in computing and communications, which have led to the design and implementation of robotic and automation systems consisting of networked vehicles, sensors, and actuator systems. These developments enable researchers and engineers not only to design new robotic systems but also to develop visions for systems that could have not been imagined before. There is a need now for a unifying paradigm within the computing, robotics, and control communities to address the design of these networked systems.

A concrete example is the interaction of intelligent sensors and pervasive networking technology which gives wireless sensor networks a new kind of scope that can be applied to a wide range of uses: environmental and habitat monitoring, precision agriculture, indoor climate control, surveillance, treaty verification, and intelligent alarms [1].

This poster addresses the experimental plans and the deployment of a system for wildfire detection based on wireless sensor nodes capable of measuring specific environmental parameters (temperature, humidity and light).

## 2. NEED FOR EARLY FIRE DETECTION

Experienced heat waves in Europe in the last years were one of the major causes of the unprecedented magnitude of forest fires that devastated the southern countries and, in particular, Portugal. Preliminary estimates indicate that over 10% of the Portuguese forest was devastated in only 3 weeks in the summer of 2003. In Italy, in 2002, 22 outbreaks in the same day damaged 1,000 hectares of forest. And in Sweden, in 1997, a 10-day outbreak consumed 450 hectares of forest and costs €350,000.

Several studies were conducted at the European level (see [2]) and from all the lessons learnt the most important was that “the best way to fight a forest fire is to prevent it”. Moreover, study of typical forest fires determined that there are three important events in the evolution of a fire: initiate fire (IF); detect fire (DF); and fight fire (FF). The time to detection (TD) is the time elapsed between IF and DF. The time to intervention (TI) is the time elapsed between DF and FF. The reduction of both TI and TD may be crucial to prevent the propagation of the fire and to limit its action. The factors affecting TD are: Time of the day; Location; Type of terrain. The factors affecting TI are: Time of the day; Location and accessibility; Distance from sources of water.

By reducing the time to detection, the early warning fire detection systems will contribute to restrict the propagation of forest fires. Moreover, associated with autonomous fire fighting capabilities (see [5]) may be able to reduce fire propagation and to prevent the occurrence of situations where a fire may run unattended for hours, especially in the case of remote locations.

## 3. SYSTEM ARCHITECTURE

The purposed architecture is based in a network of tiny wireless sensors. The wireless sensor nodes are composed of environmental sensors collecting temperature, relative humidity, and light attached to a wireless, networked MOTE. The motes communicate with each other forming an ad-hoc wireless sensor network capable of monitoring the evolution of these parameters on a pre-determined forest area. The network communicates with a base station which stores, processes and relays collected information. This information is locally available at the base station or can be accessed through any wireless device (laptop, PDA) if the base station is equipped with standard wireless communication.

The base station relays the collected data and analysis results to services running on a web server through a GSM/GPRS uplink. This web server makes the information available to authorized users, which can view and manipulate the data with a browser through a specific web application. Web publishing through Web services and other interfaces gives researchers and civil protection authorities seamless access to information.

When the level of threat, defined in terms of environment parameters, reaches a pre-defined level the base station sends a warning message to the forest guard or directly to the local fire department.

Remote operators can diagnose network node failures and react accordingly by changing the network setup.

Further details can be found in [4].

## 4. PILOT EXPERIMENT

Several pilot experimentations of the system were run at Peneda-Gerês National Park [5] in the north region of Portugal this semester. The first experiment was deployed over an area of 7 hectares, using only 7 nodes. The last experiment had already 32 wireless nodes, covering an area of more than 20 hectares. These experiments helped us studying the aspects of each deployment which lead to specific solutions namely in what concerns routing,

optimal sensor placing and efficient retrieval of the deployed nodes. A new application, called MonSense, was created to receive and collect the data from the wireless sensor network and has evolved according to the new requirements found during each experiment. The existent version helps an inexperienced user to deploy a WSN and after this task, allows him to monitor the network state, view the current and past gathered data.

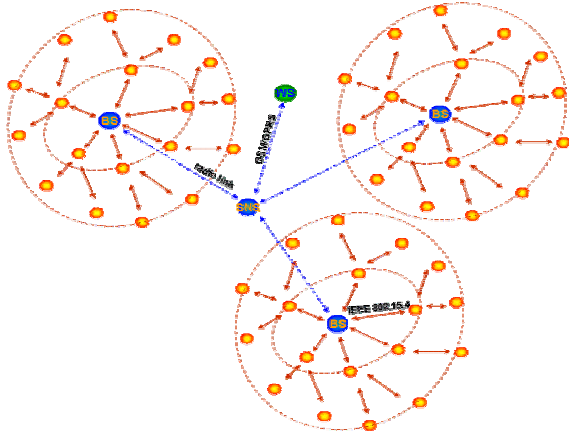

Figure 1 – EWFDS Architecture

Each node contains a Tmote Sky [6] device, a battery pack and a 5 dBi antenna, all protected by a weather resistant plastic container. By default, the nodes contains sensors for measuring temperature, relative humidity and luminosity, but other types of sensors can be added like: wind direction and speed sensors, barometric pressure sensors, rainfall sensors, etc...

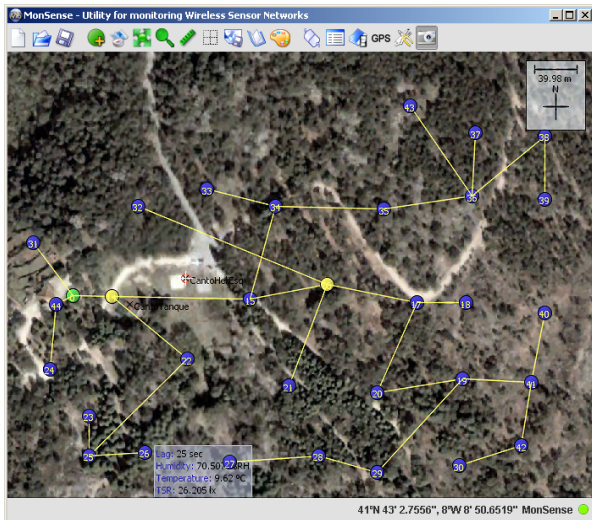

Figure 2 – MonSense Application



Figure 3 – EWFDS Node

## 5. REFERENCES

- [1] David Culler, Deborah Estrin and Mani Srivastava, Overview of Sensor Networks, Computer, August 2004, pp. 41-49.
- [2] Alessandro G. Colombo and Ana V. Arellano (editors), NEDIES Project - Lessons Learnt from Forest Fires Disasters, Report EUR 20662, Joint Research Center, 2003
- [3] Vijay Kumar, Daniela Rus and Sanjiv Singh, Robot and Sensor Networks for First Responders, Pervasive Computer, October – December 2004, pp 24-33
- [4] Alexandre Sousa, José Pinto, Gil Gonçalves and João Sousa, Deployment of an Early Warning Fire Detection System, Robotics: Science and Systems Conference, August 2006 (submitted)
- [5] Parque Nacional da Peneda-Gerês – Official home page <http://www.geira.pt/pnpg/index.html>, December 2005
- [6] MoteIV Corporation <http://www.moteiv.com/>, December 2005
- [7] TinyOS Community Forum <http://www.tinyos.net/>, December 2005

# Poster Abstract: Sensor Fusion in multirobot workcell using sensor networks

Mikko Sallinen  
 VTT Telecommunications  
 Kaitoväylä 1  
 90571 Oulu, Finland  
 +358 40 7235263  
 mikko.sallinen@vtt.fi

Tapio Heikkilä  
 Systems Engineering Laboratory  
 University of Oulu  
 P.O. Box 4400, 90014 University of Oulu, Finland  
 +358 40 3010313  
 tapio.heikkila@nethawk.fi

## ABSTRACT

In this paper, we present calculation methods for fusing measurements coming from the several measurement locations around the multirobot workcell. In the fusion, we use Bayesian – form fusion and after that, iterative estimation of the parameters. We shortly illustrate the application of sensor networks of robot-based sensor system which can be applied in several industrial applications.

## Keywords

sensor fusion, multi-robot system, spatial uncertainty, Bayesian estimation

## 1. INTRODUCTION

Sensor Fusion is an important part of the flexible robotics. Due to availability of relatively cheap sensors for e.g. use for robots, new kind of sensor networks and configurations can be designed. One possibility is to replace accurate and expensive sensors by cheap and poor resolution sensors and by fusing information coming from several sensors to achieve the same level of measurements. This paper is organized as follows: in chapter 2 we introduce the fisher –based sensor fusion and in chapter 3 we give a short explanation of one application. In chapter 4 we draw conclusions of the proposed method.

## 2. FUSION USING FISHER METHOD

### 2.1 General description

The Fisher method [1] is used for fusing the measurements and their respective uncertainties in the present work, i.e. linearized models for each sensor. The system is based on sensor networks and is flexible and designed to be open for any kind of logical sensors acquiring range data. The requirement for sensor fusion arises from the flexibility and computational limits of the current system. When using a laser rangefinder with a laser stripe, one measurement produces a large number of measurement points. Because computation of the Jacobian and weight matrices for several thousands of points at one time is too laborious a task, the measurement data can be divided into several sets and estimation can be carried out in several steps, see figure 1. In addition, the system is easy to expand to include new sensors providing information about the environment.

The process in figure 1 goes top down. The main procedures are different calibrations of robot system. These calibrations are

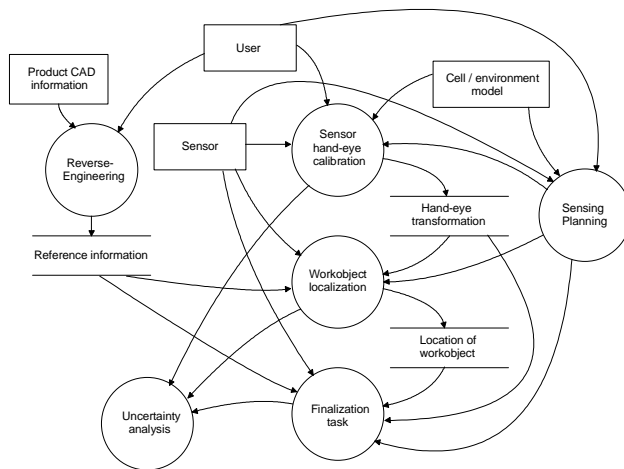

Figure 1. Process flow for the estimation of spatial relations in a robot-based workcell

carried out based in measurements from sensor networks distributed in robot workcell. The system is dynamic which means calibrated spatial transformations can be updated on-line. To ensure the correctness of the estimates, each measurement is weighted with respect uncertainty. This enables system to be same time flexible and reliable.

Flexibility of the system enables also plug-and-play features of the system. New sensors can be added to the network or old can be replaced. For the estimation, uncertainty of each sensor just have to know. If there is no noise model for the new sensor, very high level uncertainties will be used. This concept supports also use of cheap and inaccurate sensors when total accuracy of sensor network can be estimated. There is also possibility to plan optimal or close to optimal measurements in the sensor network. The planning is based on known estimation and noise models of the system.

Using the parameter estimation methods an estimate and its respective error covariance matrix can be calculated, and this procedure is repeated until all the measurements have been used for computing local estimates. The estimates from two measurements can be combined using the following equation:

$$\hat{m} = \bar{P}_{tot} \bar{P}_c^{-1} \bar{m}_{estimate,c} + \bar{P}_{tot} \bar{P}_{tot,c-1}^{-1} \bar{m}_{estimate,c-1} \quad (1)$$

where

$\bar{P}_{tot}$  is the combined covariance of the new measurement and previous covariance

$\bar{P}_{c-1}$  is the covariance matrix obtained from the previous iteration step

$\bar{P}_{tot,c-1}$  is the total uncertainty from the previous iteration step

$\bar{m}_{estimate-1}$  are the estimates for the parameters

$\bar{m}_{estimate,c-1}$  are the estimates for the parameters from the previous iteration step

The combined covariance  $\bar{P}_{tot}$  can be calculated by combining the error covariances of the current parameters and the error covariance matrix of the total uncertainties for all the previous measurements:

$$\bar{P}_{tot} = (\bar{P}_c^{-1} + \bar{P}_{tot,c-1}^{-1})^{-1} \quad (2)$$

When fusing state parameters and uncertainties from different sensors, one has to be very careful with the forms of spatial representation (A, B or C) [2]. Error covariances that are to be combined have to be in the same form.

## 2.2 A recursive algorithm for fusing measurements and uncertainties

Given equations can be written in the form of a recursive algorithm in which the different steps are explained. This can mainly be divided into two phases, estimation of parameters and their uncertainties and fusion of the estimates and their uncertainties. The parameter estimation is similar to that presented in the previous chapter. The recursive algorithm works as follows:

- 1 Set the initial value for parameters  $\bar{m}_s$  to be estimated and their covariance  $\bar{P}_{c-1}$ .
- 2 Take every n:th point from each measurement pose, in such way that the matrices in the calculation will not become too small or too large.
- 3 Calculate the correction  $\Delta \bar{m}$  for the estimated parameters.
- 4 Update the estimated parameters  $\bar{m}_s$  using the correction  $\Delta \bar{m}$ .
- 5 If the corrections  $\Delta \bar{m}_s$  are close enough to zero, go to the next phase, otherwise go to step 3.
- 6 The estimates for the parameters are now in the vector  $\bar{m}_s$ . Calculate the covariance matrix  $\bar{P}_c$ .
- 7 Reiterate steps 1-6 until all the data have been processed. There should then be n values for the estimates  $\bar{m}_s$  and n values for the respective covariances  $\bar{P}_c$ .

- 8 Calculate the total covariance  $\bar{P}_{tot}$  and the respective estimates. Continue calculation until all the estimates and covariances have been processed.
- 9 The resulting  $\bar{P}_{tot}$  and estimates  $\hat{m}$  are the error covariance matrix and estimates for the estimated parameters.

The final estimate  $\hat{m}$  and respective covariance  $\bar{P}_{tot}$  can be upgraded by using them as the previous estimate  $\bar{m}_{estimate-1}$  and covariance  $\bar{P}_{tot,c-1}$  and fusing them with new data. When combining new data with the estimates, one nevertheless has to be careful not to include very biased data, especially with low-level uncertainties attached, because this will have quite a large effect on the final estimate [2].

The same method can be used when data is collected from different sensor nodes. The algorithm is designed to be insensitive for the measurements and their sources. Architectural location of the fusion algorithm is in the middleware layer.

## 3. EXPERIMENTAL TESTS

The algorithms were tested by simulations. As expected, the estimation algorithm behaved well and each individual pose estimation was obtained with less than six iteration steps. The reduction of the uncertainties when the amount of the measurements is increasing was simulated [2].

Considering the first standard deviations of the errors (square roots of the eigenvalues of the covariance matrix), the first 20 iteration phases has the largest impact on the uncertainties of the estimated parameters. By examining the results as a curve, it has a form of a log function which describes the principle of the recursive algorithm.

## 4. CONCLUSIONS

The combining of several measurements with respect to uncertainties was presented in this paper, and a Fisher-form sensor fusion method was described which can be used computationally for this purpose. The main motivation for the use of sensor fusion in the estimations of coordinate transformations presented here is to utilize all the measurement information obtained from a sensor. Another important advantage is the improvement in accuracy when updating the estimate afterwards. This means that the accuracy of the estimate can be improved by adding the new measurements to the estimate without calculating all the data again.

## 5. REFERENCES

- [1] Luo, R.C., Lin M-H., 1988. Robot multi-sensor fusion and integration. Optimum estimation of fused sensor data, Proc. Of IEEE Int. Confrence of Robotics and Automation, 1988, pp.1076-1081.
- [2] Sallinen, M. 2003. Modelling and estimation of spatial relationships in sensor-based robot workcells VTT Electronics, Espoo. 218 p. VTT Publications: 509, ISBN 951-38-6247-X; 951-38-6248-8.

# Poster Abstract: Energy-Efficient Distributed Support Vector Machines for Wireless Sensor Networks

K. Flouri  
Department of Computer  
Science, University of Crete  
FORTH-ICS, Greece  
flouri@ics.forth.gr

B. Beferull-Lozano  
Instituto de Robótica  
Universidad de Valencia  
ETSI, Spain  
baltasar.beferull@uv.es

P. Tsakalides  
Department of Computer  
Science, University of Crete  
FORTH-ICS, Greece  
tsakalid@ics.forth.gr

## ABSTRACT

As the research field of mobile computing and communication advances, so does the need for a distributed, ad-hoc wireless network of hundreds to thousands of microsensors, which can be randomly scattered in the area of interest. In this paper, we present two energy-efficient algorithms to perform distributed incremental learning for the training of a Support Vector Machine (SVM) in a wireless sensor network, both for stationary and non-stationary sample data (concept drift). Through analytical studies and simulation experiments, we show that the two proposed algorithms exhibit similar performance to the traditional centralized SVM training methods, while being much more efficient in terms of energy cost.

## 1. INTRODUCTION

One of the most significant tasks to be performed by a wireless sensor network (WSN) is classification, that is, the action to infer whether the samples measured by the sensors belong to a certain hypothesis or not. It is well known that Support Vector Machines have been successfully used as classification tools in a variety of areas [1]. Training a SVM calls for solving a quadratic programming (QP) problem, in a number of coefficients equal to the number of training examples. Because of this fact, for very large data sets standard numeric techniques for QP become infeasible. In addition, already proposed incremental optimization approaches are not useful for true distributed learning in the context of WSNs, where there exist important constraints in terms of memory and power available at the sensor nodes.

On the other hand, an appealing feature of SVMs that make them well suited to be trained incrementally is the sparseness representation of the decision boundary they provide. The location of the separating hyperplane is specified via real-valued weights on the training samples. But only training samples that lie close to the decision boundary between the two classes, the so-called *support vectors*, receive non-zero weights. In fact, since SVMs can be specified by a small number of support vectors, as compared to the total number of training samples, they provide a compact representation of the data to which new examples can be added as they become available.

In Section 2, we take advantage of this compact representation in order to propose two energy-efficient distributed learning algorithms for WSN deployments. In Section 3, we present a set of simulation experiments in order to assess the performance of our proposed approaches vis-à-vis the performance of a representative centralized SVM algorithm. Finally, we verify the energy efficiency of the new algorithms through analytical studies of the energy cost in both the decentralized and centralized cases.

## 2. DISTRIBUTED TRAINING OF A SVM

Let us consider a deployment of sensors taking measurements in a certain area. Our goal is to be able to train a SVM in an efficient and distributed fashion so that: a) we can get good classification results on test data and b) our algorithms can be used easily in the context of WSN, where the training must take place across sensors. With this motivation, we propose two novel distributed algorithms in order to train incrementally a SVM in a WSN scenario using an energy-efficient clustering protocol.

**A. Distributed Fixed-Partition SVM training:** Typical fixed-partition techniques divide the training samples in batches (clusters of sample vectors) of fixed size. This type of algorithms seems appropriate for training incrementally a SVM using *only* partial information at each incremental step [4]. For the WSN scenario, we propose a Distributed Fixed-Partition algorithm (DFP-SVM) where the final estimation of the separating hyperplane is obtained incrementally through a sequence of estimation steps that take place at each data cluster. The key idea behind this incremental algorithm is that instead of transmitting to the next clusterhead all the measurements of the previous cluster, only the current estimates of the hyperplane-defining support vectors are transmitted, thus reducing significantly the power spent for communication (cf. Figure 1).

As we show in our experimental results of Section 3, after only a complete pass through all the clusters, a good approximation of the optimal separating plane is obtained, that is, the separating hyperplane is very similar to the one obtained using a centralized power consuming algorithm, where all the sample data must be transmitted to a central location for processing.

**B. Weighted DFP-SVM training:** In many real world applications, the concept of interest (definition of classes to be separated) may be time-varying or space-varying; similarly, the underlying data distribution may change as well. Often these changes make the model built on old data inconsistent with the new data, hence regular updating of the model is necessary. This problem, known as *concept drift*, complicates the task of learning in SVM. An example where data distribution changes over space is vehicle tracking for surveillance or monitoring of a hostile environment. In this case, sensors should track all kinds of vehicles that pass through the area and probably have different characteristics such as weight, size, and shape.

In the case of distributed sequential training of a SVM in a WSN, this effect is even more accentuated: As the data is presented in several batches, changes in the target concept may occur between different batches of data. To address this problem, one needs to make the error on the old support vectors (representing the old learning set), more costly than the error on the new samples.

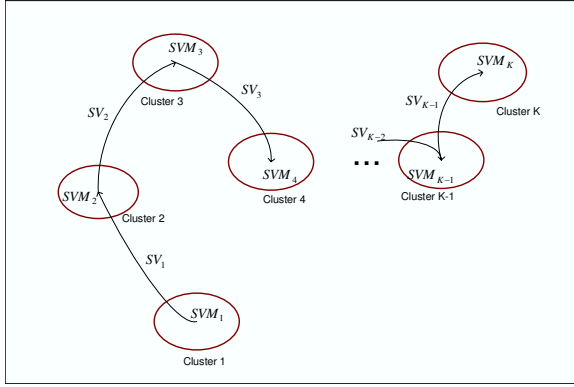

**Figure 1: Scheme of distributed training of a SVM:** For each cluster, the estimation  $SVM_i$  at clusterhead  $i$  is obtained combining the support vectors ( $SV_{i-1}$ ) of the previous estimation  $SVM_{i-1}$  calculated at cluster  $i-1$  and all the sample vectors measured by the sensors belonging to cluster  $i$ .

Therefore, we modify our previously proposed algorithm according to this observation in order to make it more suitable for WSN applications where there exist concept drifts. Our approach consists of adapting Ruping algorithm [3] to the WSN context. We call this algorithm the Weighted Distributed Fixed-Partition SVM training (WDFP-SVM).

### 3. RESULTS AND DISCUSSION

In this Section, we evaluate the performance of the two proposed distributed algorithms in terms of the average classification error rate and we compare them to the traditional centralized SVM training algorithm, which requires sensor nodes to forward all the information contained in the observations to a classification center [2]. At the same time, we verify analytically that the energy consumption decreases when the SVM is trained in a distributed fashion.

We consider a sensor network composed of 300 nodes uniformly distributed in the field, where each of the sensors collects sample vectors from two classes. In our experiments, we generate the sample data of the two classes using two Gaussian distributions with two different means. We simulated 500 Monte Carlo runs in order to test the performance of these two distributed algorithms on this set. Figure 2 represents the average error rates (%) for our two proposed algorithms as a function of the consecutive incremental steps. It is shown that with only one pass across the clusters, both distributed algorithms converge to the same average classification error rate obtained with the centralized algorithm that uses all data.

At this point, we would like to investigate the benefits in terms of energy in a wireless sensor network using these distributed algorithms for training a SVM. Specifically, we are interested in the comparison of energy consumed by the proposed distributed algorithms to a scheme where all sensors transmit their data to a fusion center for processing.

Consider the arrangement of  $n$  sensors in a cubic lattice where each sensor is at distance  $d$  of a neighbor sensor. Now, separate the sensors in  $K$  clusters of  $(2k+1) \times (2k+1)$  sensors each. Each sensor consumes  $E_K(d)$  energy for transmitting its measurements to the clusterhead and each cluster consumes  $E_{sv}(d)$  energy for the transmission of  $N_i$  support vectors to the next clusterhead  $i+1$ .

The total energy consumed for the distributed training of a SVM

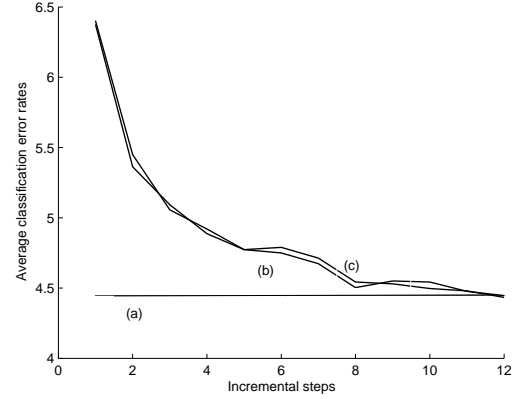

**Figure 2: Performance of the training algorithms:** The average error rate of 500 Monte Carlo runs after training the SVM for consecutive incremental steps applying the centralized algorithm (line (a)), DFP-SVM (curve (b)) and WDFP-SVM (curve (c)).

using the proposed algorithms is  $E_d(d) = E_{sv}(d) + E_K(d)K$ , or:

$$E_d(d) = (2k+1)d^2(N_1 + N_2 + \dots + N_{K-1}) + (6d^2k(k+1) + 8d^2 \sum_{j=1}^{k-1} \sum_{i=1}^{k-j} 2(k-i) + \sum_{j=1}^{k-1} j(k-j))K.$$

On the other hand, the power cost for the direct transmission of the measurements of  $(2k+1) \times (2k+1)$  sensors to the base station is given by the expression:

$$E_c(d) = 8d^2 \sum_{j=1}^{k-1} \sum_{i=1}^{k-j} (i^2 + (k-i+1)^2) + 2d^2k(k+1)(2k+1).$$

We simulated 500 Monte Carlo runs in order to estimate the power consumed during the distributed training of a SVM. For a scenario of  $n = 225$  sensors in a square grid arrangement separated in  $K = 9$  clusters consisting of 25 sensors each (hence  $k = 2$ ), the power cost for the training of the SVM using the proposed distributed algorithm is  $E_d(d) = 3380d^2 + 9 \cdot 60d^2 = 3920d^2$ , while in the centralized case the cost is  $E_c(d) = 8400d^2$ . This simulation experiment shows that the proposed distributed algorithm is much more efficient in terms of energy consumption than the centralized algorithm, since it reduces the energy cost by more than 50%.

### 4. REFERENCES

- [1] K. Bennett and C. Campbell. Support vector machines: Hype or hallelujah. *ACM Special Interest Group on Knowledge Discovery and Data Mining (SIGKDD) Explorations*, 2,2:1–13, 2000.
- [2] E. Osuna, R. Freund, and F. Girosi. An improved training algorithm for support vector machines. In *Proc. IEEE Workshop on Neural Networks and Signal Processing, NNSP'97*, pages 276–285, Amelia Island, FL, September 1997.
- [3] S. Ruping. Incremental learning with support vector machines. In *Proc. IEEE Int. Conf. on Data Mining*, pages 641–642, San Jose, CA, USA, November 2001.
- [4] N. Syed, H. Liu, and K. Sung. Incremental learning with support vector machines. In *Proc. 16th Int. Joint Conf. on Artificial Intelligence, IJCAI'99*, July 1999.

# Poster Abstract: A Theoretical Analysis of Routing Protocols in Wireless Sensor Networks

Juan José Vinagre  
Departamento de Teoría de la  
Señal y Comunicaciones  
Universidad Rey Juan Carlos  
de Madrid  
Fuenlabrada, Spain  
juanjose.vinagre@urjc.es

Antonio J. Caamaño  
Departamento de Teoría de la  
Señal y Comunicaciones  
Universidad Rey Juan Carlos  
de Madrid  
Fuenlabrada, Spain  
antonio.caamano@urjc.es

Javier Ramos  
Departamento de Teoría de la  
Señal y Comunicaciones  
Universidad Rey Juan Carlos  
de Madrid  
Fuenlabrada, Spain  
javier.ramos@urjc.es

## ABSTRACT

In this work we investigate, through a theoretical formulation of the routing process in Wireless Sensor Networks (WSN), the characteristics of all routing algorithms based on a universal measure which we define as the *effective length* of the routing protocol. The study of both the effective length and the moments of the *end to end distribution* of the routing process reveal some interesting questions as to the pertinence of the use of any routing protocol with finite effective length in Dense WSN. Our theoretical analysis shows that routing protocols that fall in the former category will behave as a purely random walk routing protocol in dense enough WSN.

## 1. INTRODUCTION

The need for efficient routing in WSN, has given birth to a plethora of routing protocols. These have been developed with different optimisation criteria in mind, being those minimisation of the number of hops to reach destination, number of retransmissions, energy efficiency or topological considerations[2]. With the advent of “dense networks”, and the results associated with the capacity associated to them [1], the importance of efficient routing algorithms is more than evident.

We will formulate the routing process in terms of a chain of  $N$  links  $\Delta \mathbf{x}_n$  of length  $a$  which is immersed in a dense WSN. First, we will study theoretically the *End to End Distribution* (or E2ED, which gives the pdf of the lengths of a vector joining source and destination of the communication) of a Random Routing Protocol, i.e., a random walk of a packet going from the source node to the destination node, hopping through as many links is necessary and with no defined orientation of the next hop. Then we will focus in the study of a route where the orientation is built in the routing protocol and defines a preferred angle in the different hops between source and destination.

## 2. E2ED OF ROUTING PROTOCOLS

We will begin with the RRP. Let us define a random chain consisting in  $N$  links of length  $a$  whose rotational angles occur all with equal probability (Figure 1).

In three dimensions, the probability distribution of the end-to-end distance vector  $\mathbf{x}_b - \mathbf{x}_a$  of such an object is given

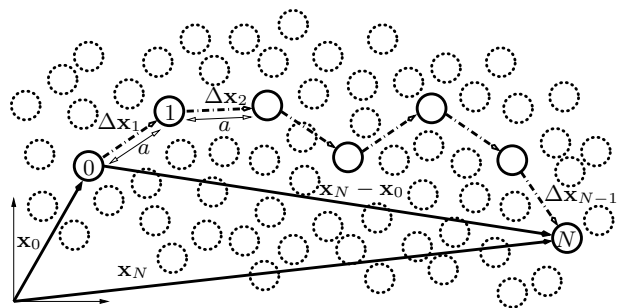

Figure 1: Routing path in a WSN consisting of  $N$  links  $\Delta \mathbf{x}_n$  of length  $a$ , connecting  $\mathbf{x}_a = \mathbf{x}_0$  and  $\mathbf{x}_b = \mathbf{x}_N$ .

by

$$P_N(\mathbf{x}_b - \mathbf{x}_a) = \prod_{n=1}^N \left[ \int d^3 \Delta x_n \frac{1}{4\pi a^2} \delta(|\Delta \mathbf{x}_n| - a) \right] \times \delta^3(\mathbf{x}_b - \mathbf{x}_a - \sum_{n=1}^N \Delta \mathbf{x}_n) \quad (1)$$

If we look at equation 1 in terms of the Fourier transform of the one-link probabilities  $\tilde{P}_1(\mathbf{k})$ , we will obtain the desired integral as

$$P_N(\mathbf{R}) = \int \frac{d^3 k}{(2\pi^3)} \left[ \tilde{P}_1(\mathbf{k}) \right]^N e^{i\mathbf{k}\mathbf{R}} = \frac{1}{2\pi^2 R} \int_0^\infty dk k \sin kR \left[ \frac{\sin ka}{ka} \right]^N \quad (2)$$

where we have introduced the end-to-end distance vector

$$\mathbf{R} \equiv \mathbf{x}_b - \mathbf{x}_a \quad (3)$$

If we express the Fourier transform of  $P_N(\mathbf{R})$  in terms of the moments of the E2ED of the RRP, we obtain

$$\tilde{P}_N(\mathbf{k}) = \sum_{l=0}^{\infty} \frac{(-1)^l (k)^{2l}}{(2l)!} \frac{1}{2l+1} \langle R^{2l} \rangle \quad (4)$$

If we calculate the first moment of the E2ED of the RRP

we find the following scaling law

$$\langle R^2 \rangle_{\text{RRP}} \propto a^2 N \quad (5)$$

For the DRP, we formulate the directionality of the hop from one node to the following in a simple expression that we will define as the *energy of the direction*. This energy will address the difference between the RRP (where the directionality was nonexistent) and the DRP. Let us define this energy as

$$E_{\text{DRP}}^N = \frac{\kappa}{2a} \sum_{n=1}^N (\mathbf{u}_n - \mathbf{u}_{n-1})^2 \quad (6)$$

The E2ED of the DRP over a distance

$$\mathbf{R} \equiv \mathbf{x}_b - \mathbf{x}_a = a \sum_{n=1}^N \mathbf{u}_n \quad (7)$$

with the directions of the initial and final pieces is then given by the path integral[3]

$$P_N(\mathbf{u}_b, \mathbf{u}_a; \mathbf{R}) = \frac{1}{A} \prod_{n=1}^{N-1} \left[ \int \frac{d^2 \mathbf{u}_n}{A} \right] \delta^3(\mathbf{R} - a \sum_{n=1}^N \mathbf{u}_n) \times \exp \left[ -\frac{2\pi a}{A^2} \sum_{n=1}^N (\mathbf{u}_n - \mathbf{u}_{n-1})^2 \right] \quad (8)$$

(where  $A$  is a measure factor) is given by

$$P_N(\mathbf{R}) = \int d^2 \mathbf{u}_b \int \frac{d^2 \mathbf{u}_a}{4\pi} P_N(\mathbf{u}_b, \mathbf{u}_a; \mathbf{R}) \quad (9)$$

If we define an *effective length* of the DRP that characterises the neighbourhood of direct influence of the DRP as

$$a_{\text{eff}} = 2\xi = \frac{2\pi a}{A^2} \quad (10)$$

we are able to show that the first nonzero moment of the E2ED of the DRP is

$$\langle R^2 \rangle_{\text{DRP}} \propto a_{\text{eff}}^2 N \quad (11)$$

See Figure 2 for the plot of the E2ED for DRP with different effective lengths.

If we take the extreme of the DRP as a Routing Protocol with Full Directionality (i.e.  $E_{\text{DRP}}^N \rightarrow \infty$ ), we find that the first nonzero moment of the resulting E2ED is

$$\langle R^2 \rangle_{\text{DRP-FD}} \propto a^2 N^2 \quad (12)$$

### 3. ROUTING PROTOCOLS IN DENSE NETWORKS

The scaling laws for the different routing protocols are transformed into a general scaling law with a *critical exponent*  $1/2 \leq \nu \leq 1$

$$\langle R^2 \rangle \propto a^2 N^{2\nu} \quad (13)$$

Let us define  $L = aN$  as the length of the routing path. Therefore, we see that as the directionality of the Routing Protocol increases, so its effective length does, till it reaches

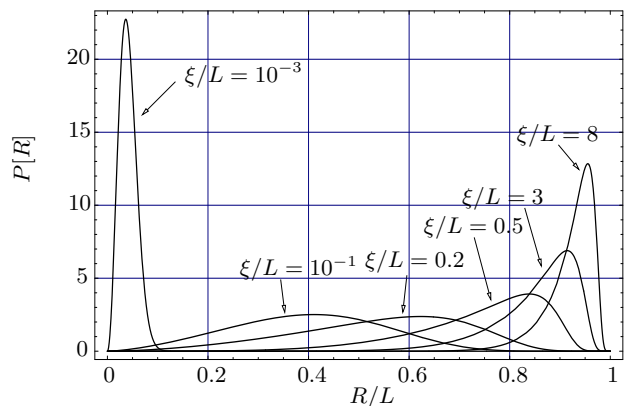

**Figure 2: End to End Distribution of a 3D Network for Routing Protocols with different effective lengths  $\xi$ .**

the full extent of the routing path. But the problem with dense networks is that the length of the routing path is increased as new nodes are brought into the network. Meanwhile, the effective length of the routing protocol stays fixed. So we are able to see that in dense enough networks, with a routing protocol with a finite effective length (i.e. knowledge of the neighbourhood of a node and therefore, directivity), the behaviour will be that of the RRP. We will end up with packets hopping with a random walk throughout the WSN, searching for its destination node.

## 4. CONCLUSIONS

We investigated theoretically the characteristics of all routing algorithms in WSN. The study of both the effective length and the moments of the *end to end distribution* of the routing process shows that most routing protocols will behave as a purely random walk routing protocol in dense enough WSN.

## 5. ACKNOWLEDGMENTS

We would like to acknowledge extremely useful discussions with Dr. Mark Wilby and Javier Simó Reigadas that contributed greatly to this work.

## 6. ADDITIONAL AUTHORS

Additional author: Eduardo Morgado Reyes, Departamento de Teoría de la Señal y Comunicaciones, ETSIT-URJC, email: [eduardo.morgado@urjc.es](mailto:eduardo.morgado@urjc.es).

## 7. REFERENCES

- [1] P. Gupta and P. R. Kumar. The capacity of wireless networks. *IEEE Transactions on Information Theory*, 46(2):388–404, 2000.
- [2] H. Karl and A. Willig. *Protocols and Architectures for Wireless Sensor Networks*. John Wiley and Sons Ltd., 2005.
- [3] H. Kleinert. *Path Integrals in Quantum Mechanics, Statistic, Polymer Physics and Financial Markets*. World Scientific, 3rd edition, 2004.



# Poster Abstract: Wireless Sensor Networks in Agricultural Applications (Field Studies)

Alexander Coers  
Fraunhofer-Institute for  
Microelectronics Circuits  
and Systems  
Finkenstrasse 61  
47057 Duisburg, Germany

Markus Holzapfel  
Fraunhofer-Institute for  
Microelectronics Circuits  
and Systems  
Finkenstrasse 61  
47057 Duisburg, Germany

Hans-Christian Müller  
Fraunhofer-Institute for  
Microelectronics Circuits  
and Systems  
Finkenstrasse 61  
47057 Duisburg, Germany

## Keywords

Wireless Sensor Networks, Wireless Measurement and Control

## 1. INTRODUCTION

If plants are to grow to their full potential in greenhouses, precise climate control is required to reduce running costs. In the past over 90 percent of their total energy consumption went just on heating. By precisely setting the optimum climate for each type of plant and vegetable in the greenhouse, they will grow faster and better. Gardeners need to monitor and to control air temperature and humidity, soil temperature and humidity, and many other factors at various points in order to maximise operating profit. The Fraunhofer Institute for Microelectronic Circuits and Systems (Fraunhofer IMS) have setup up a wireless sensor network at a test site near Duisburg, Germany, to do precisely this.

## 2. AGRICULTURAL PRODUCTION

Agricultural production comes along with a high use of resources, especially if it takes place in greenhouses. This concerns primarily the heat energy demand, which influences the yield per area on the one hand, and the costs of production on the other hand. A similar statement can be made about manuring and pest management. An optimisation in terms of plant growth requires the exact knowledge of the substantial operating parameters in a sufficient temporal and spatial resolution.

### 2.1 Production in Greenhouses

In co-operation with the agriculture chamber NRW, the Fraunhofer IMS has equipped some greenhouses at the horticultural centre Straelen with a wireless sensor network to determine the spatial distribution of air temperature [1]. For this purpose each network node was equipped with four temperature sensors. By means of these sensors, the air temperature in the greenhouses is measured at heights of one, two and four meters as well as directly above the plant bed. Additionally, the flow and return temperature of the heating system is observed. The measured and digitised temperature data are transmitted wirelessly to a base station. The data processing is completed on a PC attached to the base station. The purpose of this cooperation is to determine the potential of saving heat energy in greenhouses.

### 2.2 "Mobile" Plants

A second application deals with the supervision of parameters specific for plants like air temperature, air humidity, soil temperature, soil humidity and light intensity. The supervised plants are not located stationary in beds but in planting bins, which are positioned in varying greenhouses according to the vegetation phase. Obviously, a wired transmission of the sensor data is not feasible for operational reasons. However, the collection of the physical and chemical parameters mentioned above is essential for the minimisation of the resources employment.

## 3. FRAUNHOFER IMS SOLUTION

At Fraunhofer IMS radio modules have been developed that can be used to build up wireless sensor networks. These modules include a 2.4 GHz transceiver chip, which is controlled by an 8-bit microcontroller and provide standard sensor interfaces, like e.g. SPI, I<sup>2</sup>C as well as analogue and digital inputs and outputs [2]. In conjunction with a complete protocol stack, i.e. TinyOS or ZigBee, Fraunhofer can provide costumers with applications adapted to the individual customer's needs.

## 4. REFERENCES

- [1] Hans-Christian Müller, Markus Holzapfel, Alexander Coers, and Rainer Kokozinski. Drahtlose Sensornetze (Teil 2). *SENSOR report*, 2005(1):23–26, February 2005.
- [2] Markus Holzapfel. An IEEE 802.15.4 Wireless Sensor Network Node. In *Fraunhofer IMS Annual Report 2004*, pages 45–47. Fraunhofer-Institute for Microelectronics Circuits and Systems, 2004.



# Poster Abstract: Introducing Logical Neighborhoods for Programming Wireless Sensor and Actor Networks

Luca Mottola and Gian Pietro Picco  
Dipartimento di Elettronica e Informazione, Politecnico di Milano, Italy  
{mottola,picco}@elet.polimi.it

## 1. INTRODUCTION

Wireless sensor and actor networks (WSAN) are composed of heterogeneous devices that sense from and act on the environment. Applications envisioned for this kind of systems range from chemical attack detection to home automation. Usually, these are composed of many different collaborating subtasks, each affecting only a given portion of the system [1].

Differently from mainstream sensor networks—where application functionalities are mostly coordinated by a single data sink—in WSANs there is a clear need for a decentralized and fully decoupled distributed processing. Therefore, new programming abstractions are needed to manage heterogeneity and complexity efficiently.

To this end, we propose the notion of *logical neighborhood* as a way to logically partition a WSAN. Differently from *physical neighborhoods*, where a node’s physical transmissions range determines the set of devices it is able to communicate with, we here introduce an application-defined notion of neighborhood where the programmer specifies, using a declarative language we devised, the characteristics of the devices that a node wants to consider as its *logical* neighbors. Then, thanks to a communication primitive coupled to the above mentioned abstraction, a node is able to “broadcast” (in a logical sense) a message just to all members of the logical neighborhood.

The declarative language used to define our neighborhoods is designed to be an extension (not a replacement) of existing programming languages, whereas the communication primitives we provide augment (not replace) the ones already used for broadcast communication to physical neighbors. For these reasons, our abstraction may foster a new look at existing mechanisms, algorithms and programming models by replacing their conventional notion of physical neighborhood with our application-defined one.

Our framework is composed of two parts: the logical neighborhood abstraction and the routing facilities needed for communication. The former is described in Section 2, whereas the latter is illustrated in Section 3. Finally, Section 4 briefly reports on current and future work. Due to space limitations, in this paper we can only provide a concise overview. For further details, please refer [3].

## 2. LOGICAL NEIGHBORHOODS

The abstraction we propose revolves around only two concepts: *nodes* and *neighborhoods*, both expressed in a declarative language we designed called SPIDEY. Nodes represent the portion of a real node’s state and characteristics made available to the definition of any logical neighborhood. The definition of such a (logical) node

```
node template Sensor
  static Device
  static Type
  dynamic Reading
  dynamic BatteryPower

create node ts from Sensor
  Device as "sensor"
  Type as "temperature"
  Reading as getTempReading()
  BatteryPower as getBatteryPower()
```

Figure 1: Sample node definition and instantiation.

```
neighborhood template HighTempSensors(threshold)
  with Device = "sensor" and
    Type = "temperature" and
    Reading > threshold

create neighborhood htsn100
  from HighTempSensors(threshold: 100)
  max hops 2
  credits 30
```

Figure 2: Sample neighborhood definition and instantiation.

is encoded in a *node template*, which specifies a node’s exported attributes. This template is then used to derive actual instances of (logical) nodes, by specifying the actual source of data. Figure 1 reports a fragment of SPIDEY code that defines a template for a generic sensor and instantiates one (logical) node by binding attributes to constant values or functions of the target language.

A logical neighborhood can then be defined by predicates on node templates. As already illustrated for nodes, a neighborhood is defined in a template, which basically encodes the corresponding membership function, and then instantiated by specifying *where* and *how* the neighborhood is to be constructed and maintained. For instance, Figure 2 illustrates the definition of a neighborhood involving temperature sensors whose reading is above a given threshold. This template is then instantiated so that it evaluates the corresponding predicates only on nodes that are at a maximum of 2 hops away from the node defining the neighborhood, and by spending a maximum of 30 “credits”. The latter is an application-defined measure of *communication cost*, explicitly defined by supplying at each node a *sending cost function* through a particular SPIDEY construct. This describes the cost a node incurs in sending a broadcast message to physical neighbors. Clearly, this gives programmers the freedom to define this cost depending on the application goals or on a node’s underlying hardware, (e.g., defining higher cost for battery-powered sensors and lower costs for resource-rich nodes) whereas the “credits” construct expose the trade-off between accuracy and resource consumption up to the application. In addition, notice that neighborhood templates can be parameterized, with the actual parameters being bound at instantiation time.

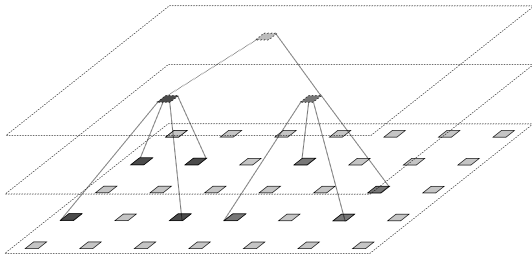

Figure 3: A hierarchy of sensors where at the lowest level are actual sensors and at above levels are derived virtual sensors. The same color is used to represent sensors belonging to the same logical neighborhood.

More advanced features of the SPIDEY language allow, in a given neighborhood template, for boolean expressions composed of the usual operators **and**, **or** and **not**, and for the specification of a required **cardinality** for nodes in a logical neighborhood. Moreover, different neighborhood templates can be combined using usual set operations such as **intersection**, **union**, and **minus**, and can also be defined as a subset of another already defined neighborhood template.

The expressive power of our language is further augmented by the possibility to provide, at node instantiation time, an aggregation function to be evaluated on an existing neighborhood. As exemplified in Figure 3, this results in a “virtual” node having attributes not bound to the underlying hardware, but instead derived from data stored on nodes in an existing (logical) neighborhood. This virtual node can then be used in the definition of other neighborhoods in a recursive manner. This way, we enable virtualization of nodes through data aggregation and hierarchical composition of neighborhoods. Notice how this allows the programmer to build higher-level abstractions while still reasoning in terms of the simple concepts of *node* and (logical) *neighborhood*<sup>1</sup>.

Finally, communication in a logical neighborhood is made available to the programmer by redefining the usual broadcast facility. In particular, we change the signature of the send operation to be **send(Message m, Neighborhood n)**, thus making it dependent on the (logical) neighborhood to which the message is addressed. To implement communication in a logical neighborhood, we need a routing mechanism able to deliver messages to neighborhood members while being resilient to nodes often going in sleep mode to save energy. In the next section we illustrate how we addressed this issue.

### 3. ROUTING AND COMMUNICATION

As the logical neighborhood abstraction is essentially independent from the underlying routing layer, several alternatives could be explored, from a simple solution exploiting a tree-based topology, to some form of sophisticated content-based routing whose forwarding strategy could be based on neighborhood templates. However, we wanted a routing mechanisms explicitly designed for efficiently supporting the abstraction we propose.

To this end, we devised a structure-less routing mechanism (i.e., a solution that does not exploit overlays) that works by periodically propagating *node profiles* containing node templates or portions thereof. This propagation builds a distributed *state space* that

<sup>1</sup>For a complete grammar of the SPIDEY language and the corresponding precise semantics, please refer to [3].

gives each device enough information to reach the closest node with some specific attribute. The cost to reach a node is computed in terms of the sending cost previously mentioned, accumulated along the shortest path to the node. In this sense, the propagation of node information gets constrained in a given portion of the system by exploiting the redundancy among similar node profiles. Moreover, a basic form of state compression is exploited to limit the memory footprint of data structures describing the distributed state space.

Messages addressed to a logical neighborhood contain the neighborhood template, thus making explicit the part of the state space that must be considered. This way, messages sent to a logical neighborhood “navigate” towards potential members by following paths along which the cost associated to that portion of the state space is decreasing.

The number of credits specified when instantiating a neighborhood are attached to each message and “spent” in navigating the state space. Each message is always sent in broadcast mode, and, whenever a decreasing path to a node is found, a *credit reservation* mechanism reserves enough credits to reach this node. On the other hand, the remaining credits are used to explore non-decreasing paths, in the hope to find further decreasing directions in other parts of the system. Clearly, this mechanism is able to tolerate the dynamic topology characteristic of sensor systems—induced by the low duty cycle of nodes—by providing multiple paths to a given destination.

As for the management of virtual nodes, several solutions are viable. At one end of the spectrum, we can require members of a neighborhood to send data to the node defining the neighborhood and perform aggregation there. On the other end, we can make each node in a logical neighborhood propagating its data to all other members, thus giving each of them a global view on the data in the neighborhood. This way, each node can perform aggregation and act as a replica of the virtual node. Clearly, the trade-off here is between redundancy of information and network traffic overhead.

### 4. CURRENT AND FUTURE WORK

We are currently working along two directions. On one hand, we are developing a front-end for the SPIDEY language, integrated into the nesC [2] language. On the other hand, we are implementing and evaluating the performance of the routing mechanism we devised in different simulated and real-world scenarios. Furthermore, we plan to investigate how our abstraction can be used to enhance higher-level communication abstractions (e.g. tuple-spaces).

### 5. REFERENCES

- [1] I. F. Akyildiz and I. H. Kasimoglu. Wireless sensor and actor networks: Research challenges. *Ad Hoc Networks Journal*, 2(4):351–367, October 2004.
- [2] D. Gay, P. Levis, R. von Behren, M. Welsh, E. Brewer, and D. Culler. The nesC language: A holistic approach to networked embedded systems. In *PLDI03: Proc. of the ACM SIGPLAN 2003 Conf. on Programming Language Design and Implementation*, pages 1–11, New York, NY, USA, 2003. ACM Press.
- [3] L. Mottola and G. Picco. Logical neighborhoods: A programming abstraction for wireless sensor and actor network, October 2005. Tech. Report, Politecnico di Milano. Available at [www.elet.polimi.it/upload/mottola/mottola05logical.pdf](http://www.elet.polimi.it/upload/mottola/mottola05logical.pdf).

# Poster Abstract: Efficient Decision Fusion with Performance Guarantees in Sensor Networks

Zinaida Benenson  
 Chair of Computer Science 4  
 RWTH Aachen University  
 zina@i4.informatik.rwth-aachen.de

Gernot Fabeck  
 Chair of Theoretical Information Technology  
 RWTH Aachen University  
 fabeck@ti.rwth-aachen.de

## ABSTRACT

We consider sensor nodes which make decisions about the state of the observed environment and transmit them to a fusion center for decision combining. We investigate how to ensure pre-specified performance guarantees for the fused decision most efficiently.

## 1. INTRODUCTION

One important task of wireless sensor networks is the detection of physical phenomena in the observed environment. Consider a set of sensor nodes which all observe the same geographic area, make decisions about the state of the observed environment (e.g., dangerous or safe), and transmit their local decisions to a fusion center (Fig. 1).

Sensor nodes are cheap, so they can be deployed densely [1]. However, their local decisions are fairly unreliable due to their low-cost design and random deployment. The fusion center combines the unreliable local decisions into a reliable fused decision which satisfies some predefined performance measures. For example, the probability of a false alarm (detecting a nonexistent event) at the fusion center is guaranteed to be below a specific value.

As sensors, as well as the communication medium, are unreliable, the fusion center should not have to wait for local decisions of *all* sensors deployed in the area before making the decision: Some sensors may have failed, or some messages may have got lost. Moreover, waiting for more local decisions increases the time of the decision fusion operation. On the other hand, if decision fusion is based on a too small number of local decisions, the fused decision may be too unprecise.

We investigate the relationship between the number of local decisions the fusion center has to wait for, and the quality of the fused decision. Given the individual error probabilities of each sensor, we determine lower bounds on the number of local decisions needed for pre-specified performance guarantees at the fusion center.

## 2. PRELIMINARIES

### 2.1 Problem Statement

We consider a binary hypothesis testing problem with hypotheses  $H_0, H_1$  describing the state of the observed environment and their associated prior probabilities  $\pi_0, \pi_1$ . A set of  $N$  sensors take measurements on the environment and make local decisions about the underlying true hypothesis.

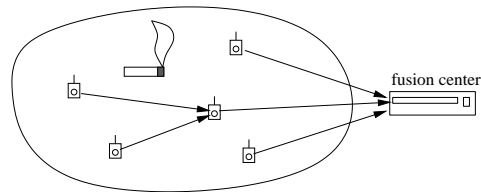

**Figure 1: Sensor nodes observe the environment and make unreliable local decisions about its state. Fusion center combines local decisions into a reliable fused decision (e.g., fire/no fire).**

Each local decision  $u_i$  is interpreted as the realization of a binary random variable  $U_i$ ,  $i = 1, \dots, N$ , which is characterized by the associated *probability of false alarm* and *probability of miss*:

$$p_f^i := P(U_i = 1 | H_0), \quad p_m^i := P(U_i = 0 | H_1).$$

The local decisions  $u_1, \dots, u_N$  form the input to the fusion center which combines them to yield the global decision  $u = f(u_1, \dots, u_N)$ . As in the case of local decisions, the global decision  $u$  is interpreted as the realization of a binary random variable  $U$  which is characterized by the global probability of false alarm and global probability of miss:

$$p_F := P(U = 1 | H_0), \quad p_M := P(U = 0 | H_1).$$

The overall *probability of error*  $p_E$  at the fusion center is a weighted sum of the false alarm and miss rate:

$$p_E = \pi_0 p_F + \pi_1 p_M.$$

*Performance guarantees* at the fusion center are determined by upper bounds on its respective error probabilities.

We assume that the error probabilities  $p_f^i, p_m^i$  of the sensor nodes are known and that the local decisions  $U_i$  are conditionally independent. Our aim is to assess the error probabilities  $p_F, p_M$  of the fusion center and give lower bounds on the number of reporting sensors  $N$  in order to achieve pre-specified performance guarantees at the fusion center.

### 2.2 Optimal Fusion Rules

We consider optimal fusion rules in a Bayesian framework [2]. The objective is to determine the fusion rule  $f$  that minimizes the overall probability of error  $p_E$ . The problem can be viewed as a binary hypothesis testing problem at the fusion center with local decisions being the observations.

According to Chair and Varshney [3], the optimal fusion rule in the case of conditionally independent decisions can be performed by taking a weighted sum of the incoming local decisions and comparing it with a threshold:

$$\sum_{i=1}^N \left[ \log \frac{(1-p_f^i)(1-p_m^i)}{p_f^i p_m^i} \right] u_i \begin{matrix} u = 1 \\ > \\ < \\ u = 0 \end{matrix} \log \left[ \frac{\pi_0}{\pi_1} \prod_{i=1}^N \left( \frac{1-p_f^i}{p_m^i} \right) \right].$$

For reasons of analytical tractability, we will consider equal local error probabilities  $p_f^i \equiv p_f$ ,  $p_m^i \equiv p_m$ . This yields a simplified fusion rule taking the form

$$\sum_{i=1}^N u_i \begin{matrix} u = 1 \\ > \\ < \\ u = 0 \end{matrix} \vartheta,$$

where the threshold  $\vartheta$  takes the form  $\vartheta = \alpha + \beta N$  with constants  $\alpha$  and  $\beta$ .

### 3. DECISION FUSION WITH PERFORMANCE GUARANTEES

We investigate the error probabilities of the fusion center and give a lower bound on the number  $N$  of reporting sensors needed to achieve a pre-specified performance level.

#### 3.1 Exact Expressions for Error Probabilities

In order to compute the error probabilities at the fusion center, we determine the distribution of the random variables

$$V_j := \sum_{i=1}^N U_i | H_j, \quad j = 0, 1,$$

i.e., the total number of “ones” sent by the  $N$  sensor nodes under hypothesis  $H_j$  true. It is easily shown that the random variables  $V_0$  and  $V_1$  follow a binomial distribution according to  $V_0 \sim \text{Bin}(N, p_f)$  and  $V_1 \sim \text{Bin}(N, 1 - p_m)$ .

By using the connection to the beta distribution of the first kind [4], we obtain expressions for the error probabilities  $p_F = P(V_0 > \vartheta)$  and  $p_M = P(V_1 < \vartheta)$ :

$$p_F = 1 - \frac{N!}{[\vartheta]!(N - [\vartheta] - 1)!} \int_{p_f}^1 x^{[\vartheta]} (1-x)^{N-[\vartheta]-1} dx,$$

$$p_M = \frac{N!}{([\vartheta] - 1)!(N - [\vartheta])!} \int_{1-p_m}^1 x^{[\vartheta]-1} (1-x)^{N-[\vartheta]} dx.$$

#### 3.2 Approximation by Normal Distribution

In typical wireless sensor network scenarios, the number of sensors  $N$  reporting to the same fusion center is large enough (e.g.,  $N = 20$ ), so that we may apply the Central Limit Theorem [4] to obtain a reasonable approximation for the corresponding error probabilities at the fusion center. Particularly, we obtain the expressions

$$p_F \approx 1 - \Phi \left( \frac{\vartheta - N p_f}{\sqrt{N p_f (1 - p_f)}} \right),$$

$$p_M \approx \Phi \left( \frac{\vartheta - N(1 - p_m)}{\sqrt{N p_m (1 - p_m)}} \right),$$

where  $\Phi$  is the cumulative distribution function (cdf) of the standard normal distribution.

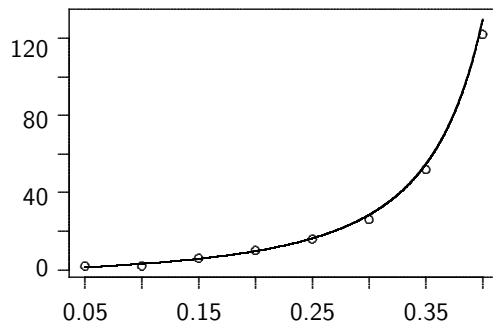

Figure 2: A lower bound on the number of sensors  $N$  needed to guarantee the performance level  $p_E \leq 0.01$  at the fusion center of the symmetric system for various local error probabilities. Circles depict exact values, the line depicts the approximation.

#### 3.3 Special Case: Symmetric System

We illustrate the validity of our approximation by the special case of a *symmetric system*, i.e.,  $\pi_0 = \pi_1 = \frac{1}{2}$  and  $p_f = p_m = p_e$ .

In this case, we have  $p_F = p_M = p_E$  and thus we can impose a unique lower bound on the number of sensors  $N$  to guarantee the restriction  $p_E \leq \varepsilon_E$  on both the false alarm and the miss rate at the fusion center by the same value  $\varepsilon_E$ :

$$N \geq \left( \frac{2\Phi^{-1}(\varepsilon_E) \sqrt{p_e(1-p_e)}}{1-2p_e} \right)^2.$$

The relationship between the necessary number of sensors  $N$  and the local error probability  $p_e$  is depicted in Fig. 2 for the specific performance guarantee  $p_E \leq \varepsilon_E = 0.01$ .

### 4. FURTHER WORK

In the future, we aim to investigate the influence of correlations between local decisions on the number of sensors needed. Correlations will occur naturally due to dense deployment. Furthermore, we want to consider the case of  $m$ -ary hypothesis testing for distributed classification applications involving heterogeneous sensor types. We want to examine the possible advantages of multiple layers in the decision hierarchy. By allocating sensor nodes to fusion centers across multiple layers, we aim to achieve energy and time savings while maintaining performance guarantees on the final decision.

### 5. REFERENCES

- [1] I. F. Akyildiz, W. Su, Y. Sankarasubramaniam, and E. Cayirci. *Wireless sensor networks: A survey*. *Computer Networks*, 38(4):393–422, 2002.
- [2] P. K. Varshney. *Distributed Detection and Data Fusion*, Springer, New York, 1997.
- [3] Z. Chair and P. K. Varshney. Optimal data fusion in multiple sensor detection systems. In *IEEE Trans. Aerosp. Electron. Syst.*, 22(1):98–101–30, 1986.
- [4] A. Papoulis and S. U. Pillai. *Probability, Random Variables and Stochastic Processes*, 4th edition, McGraw-Hill, 2002.

# Poster-Abstract: A Lifetime-Efficient Forwarding Strategy for Wireless Sensor Networks

Marcel Busse, Thomas Haenselmann, and Wolfgang Effelsberg  
 Computer Science IV, University of Mannheim  
 Seminargebäude A5, D-68131 Mannheim, Germany  
 {busse, haenselmann, effelsberg}@informatik.uni-mannheim.de

## 1. MOTIVATION

Sensor Networks are mainly designed for habitat and environmental monitoring where many sensor nodes gather data that is then sent towards one or more sink nodes. Since all nodes are scattered over a wide area in most cases, they cannot communicate with the sink directly. Instead, intermediate nodes are used for message forwarding. For such many-to-one communication, some routing algorithms use distance-based forwarding where the number of hops serves as a distance metrics. However, simple hop-based approaches achieve poor results concerning data delivery and energy consumptions [1, 4]. In [1], we proposed another forwarding strategy called *Single-Link Energy-Efficient Forwarding* (SEEF) that uses an energy efficiency metric. The energy efficiency is defined as the ratio between the delivery rate and the energy required for the message to reach the sink. Furthermore, we introduced the concept of multi-link forwarding. In general, nodes that are not addressed in the packet header as the destination may temporarily turn their radio unit off to save energy. However, it might be more efficient if some nodes stay awake and overhear the packet. In case of packet loss, that might prevent retransmissions of the entire packet. If the actual receiver does not acknowledge the packet, another node may do so instead. The decision which nodes should operate in such a backup mode is due to the *Multi-Link Energy-Efficient Forwarding* (MEEF) strategy.

As shown in [1], MEEF performed best among a comprehensive framework of different forwarding strategies. However, one problem that occurs during the lifetime of the network is that some paths are used more frequently than others. Nodes along these paths will spent more energy and die pretty soon. This problem is also known as the Maximum Lifetime Problem [3].

In the following sections, we will tackle this problem and present a new *Lifetime-Efficient Forwarding* strategy that incorporates the amount of a node's remaining energy into the forwarding metrics to prevent the early "burn out" of specific paths.

## 2. LIFETIME-EFFICIENT FORWARDING

According to [1], we define  $prrr_{i,j}$  as the packet reception rate between a node  $i$  and its neighbor  $j$ ,  $e_{rx}$  and  $e_{tx}$  as the amount of energy required for the packet reception resp. transmission, and  $R$  as the number of allowed packet retransmissions. Let  $E_i^e$  be the end-to-end delivery rate of node  $i$ ,  $E_i^e$  be the overall required energy to deliver a packet to the sink,  $E_i^{eff}$  be its efficiency defined as  $E_i^e / E_i^e$ , and  $E_i^l$  be the lifetime of its forwarding path expressed in energy units. Then, for a sorted set  $\Omega_i$  of  $n$  potential forwarding nodes, the MEEF strategy locally maximizes

$$E_i^{eff} = \frac{\sum_{j \in \Omega_i} a_{i,\alpha(j)-1} prrr_{i,j} E_j^e}{\sum_{j \in \Omega_i} a_{i,\alpha(j)-1} prrr_{i,j} (E_j^e + b) + a_{i,n} b} \quad (1)$$

for each node  $j$ , with  $a_{i,k} = \prod_{j \in \Omega_i, \alpha(j) \leq k} (1 - prrr_{i,j})$ ,  $\alpha(j)$  being the position of node  $j$  in  $\Omega_i$  and  $b = e_{tx} + ne_{rx}$ .

Intuitively speaking, a node selects an optimal set of helping hands from its direct neighborhood with a small amount of effort (the denominator of Expression 1) coupled with a large delivery rate (the nominator). Those neighbors that maximize  $E_i^{eff}$  are finally chosen as forwarders. In case of  $n = 1$ , we get the SEEF strategy since only a single neighbor is chosen.

While the efficiency is one aim of a sensor network, the lifetime of a forwarding path is another orthogonal one. We account for that with the *Multi-Link* and *Single-Link Lifetime-Efficient Forwarding* (MLEF resp. SLEF) strategies which maximize  $E_i^{eff} \times E_i^l$ . Using similar calculations as in [1],  $E_i^l$  can be computed by

$$E_i^l = \frac{\left( \sum_{j \in \Omega_i} a_{i,\alpha(j)-1} prrr_{i,j} L_{i,j} \right) (1 - a_{i,n}^{R+1})}{1 - a_{i,n}} + a_{i,n}^{R+1} e_i \quad (2)$$

with  $e_i$  being the remaining energy level of a node  $i$  and  $L_{i,j} = \min\{e_i, e_j\}$ . Again,  $n = 1$  leads to the SLEF strategy.

## 3. OTHER FORWARDING STRATEGIES

We will compare the MLEF and SLEF strategies with four other schemes: (i) Hop-based Forwarding, (ii)  $E^r$ -based Forwarding, (iii) MT Forwarding, (iv) and a globally optimal LP relaxation. Let  $L = \min_{(j,*) \in \phi} \{e_j\}$  be the minimum remaining energy on a forwarding path  $\phi$  towards the sink. Then the forwarding metrics are defined as follows:

- **Hop-based Forwarding:** Based on the neighbors' hop counters, the node with the smallest hop counter  $\times L^{-1}$  becomes the forwarder. In case of equal values, the node with the best reception rate is selected.
- **$E^r$ -based Forwarding:** With  $E_i^r = \prod_{(j,k) \in \phi} (1 - (1 - prrr_{j,k})^{R+1})$  being the end-to-end delivery rate, the node that maximizes  $E_i^r \times L$  becomes a forwarder. In case of equal values, the node with the smallest hop counter is selected.
- **MT Forwarding:** MT Forwarding attempts to minimize the number of overall transmissions required to successfully deliver a packet. Assuming infinite retransmissions, the node that minimizes  $\sum_{(j,k) \in \phi} (prrr_{j,k} \times L)^{-1}$  becomes a forwarder.
- **LP Relaxation:** In order to get a globally optimal solution concerning the network lifetime, we use a linear programming model that maximizes the time until the first node runs out of energy. The optimization was carried out on condition that all packets will finally reach the sink. Since we assume infinite retransmissions, the solution can be considered

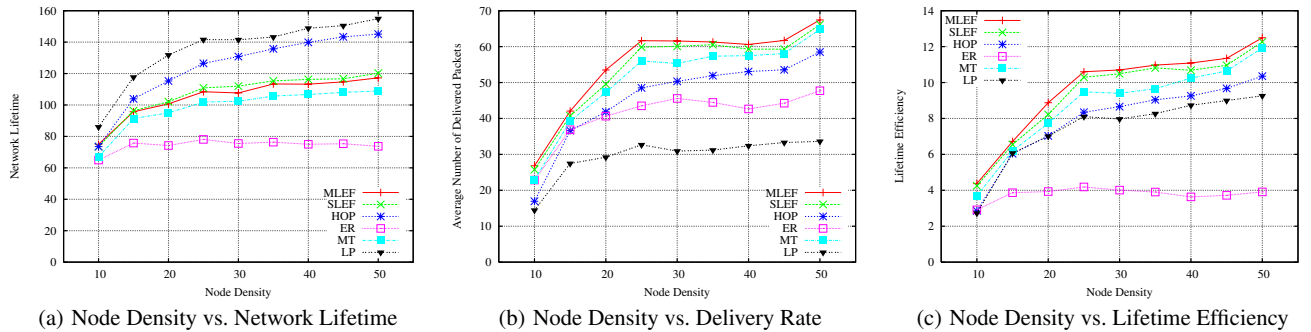

Figure 1: Influence of Node Density on Lifetime, Delivery Rate, and Lifetime Efficiency

as a relaxation of the case with finite retransmissions which is used in our simulations presented in the next section.<sup>1</sup>

#### 4. EVALUATION

The simulations are carried out on a  $100 \times 100 m$  field with a stationary and uniform distribution of nodes. The node's radio range is assumed to be fixed at  $30 m$ . We consider two nodes to be neighbors if the packet reception rate (modeled as in [1]) is at least 1%. Furthermore, we assume that each node already knows the reception rate of all its neighbors, e.g., through previously performed packet reception measurements. The number of allowed retransmissions is set to three.

The initial amount of a node's energy is set to  $0.1 J$ . According to the *first order model* described in [2], we set  $e_{tx}(d) = e_{elec} + e_{amp} \cdot d^\alpha$  and  $e_{rx}(d) = e_{elec}$  with  $e_{elec} = 50 nJ/bit$ ,  $e_{amp} = 100 pJ/bit/m^2$ , and a path loss exponent  $\alpha$  of 2. The packet size is assumed to be  $512 bit$ . The energy required for a node to stay awake is neglected, i.e., we consider the energy necessary for the transmission and reception of a packet only.

The overall network lifetime is subdivided into rounds and defined as the number of rounds until the first node runs out of energy. Each round, all nodes (except the sink) issue a data packet that is then transferred along the forwarding path towards the sink. The propagation time on a link and the processing time at a node are neglected. After each round, the forwarding paths may be changing due to decreasing energy levels.

Figure 1 shows the simulation results for node densities (number of nodes per radio range) varying from 10 to 50. Each data point indicates the average over 100 runs. Regarding the network lifetime, the LP forwarding strategy shows the best results, followed by Hop-based Forwarding. This is due to the fact that both strategies consume less energy per round than the other strategies. The LP relaxation optimizes the network lifetime only, without considering the delivery rate. Thus, in each round, the lifetime-optimal paths are chosen. On the other hand, Hop-based Forwarding focuses on short paths in terms of hops. Since in most cases the chosen links are very lossy and the number of retransmissions are limited to three, the end-to-end delivery rate will be low as well as the overall required energy per round. The high energy consumptions of an optimal end-to-end delivery strategy is shown by the  $E^r$ -based Forwarding strategy. Since in each round the delivery rates are optimized regardless of energy, it achieves the worst network lifetime.

<sup>1</sup>Note that even if infinite retransmissions are allowed, the expected number of retransmissions is finite and much lower.

Even more important than the network lifetime is the overall number of delivered data packets at the sink. That is, a network with a high lifetime but a low number of data packets received by the sink is basically worthless. As shown in Figure 1(b), the LP relaxation now performs worst, even worse than  $E^r$ -based Forwarding with the lowest lifetime. Interestingly, Hop-based Forwarding performs better than  $E^r$ -based Forwarding. Although it achieves only half of the delivery rates of  $E^r$ -based Forwarding in the beginning of the network lifetime, it benefits from a higher energy level within the network and delivers more packets for a longer time.

The best results are achieved by MLEF and SLEF. Compared to SLEF, MLEF slightly benefits from its multi-link concept, even if this requires more energy per packet (see Figure 1(a)). Concerning the lifetime efficiency defined as the ratio of overall received packets and consumed energy multiplied by the network lifetime, MLEF outperforms the other forwarding strategies as depicted in Figure 1(c). The worst result is achieved by  $E^r$ -based Forwarding due to its high energy costs.

#### 5. CONCLUSIONS

In this poster abstract, we presented an extension of our previously proposed energy-efficient forwarding schemes that now incorporates the overall network lifetime. Both MLEF and SLEF strategies performs best concerning the number of delivered data packets and lifetime efficiency. We have also shown that just maximizing the network lifetime need not to be very efficient regarding delivery rates. Furthermore, it was shown that Hop-based Forwarding even performs better than an optimal end-to-end delivery strategy over the entire network lifetime.

#### 6. REFERENCES

- [1] M. Busse, T. Haenselmann, and W. Effelsberg. An Energy-Efficient Forwarding Scheme for Wireless Sensor Networks. Technical Report 13, University of Mannheim, Dec. 2005, (under submission).
- [2] W. R. Heinzelman, A. Chandrakasan, and H. Balakrishnan. Energy-Efficient Communication Protocols for Wireless Microsensor Networks. In *Proceedings of the Hawaii International Conference on System Sciences*, Maui, Hawaii, USA, Jan. 2000.
- [3] A. Sankar and Z. Liu. Maximum Lifetime Routing in Wireless Ad-hoc Networks. In *Proceedings of IEEE INFOCOM'04*, Hong Kong, China, Mar. 2004.
- [4] A. Woo, T. Tong, and D. Culler. Taming the Underlying Issues for Reliable Multihop Routing in Sensor Networks. In *Proceedings of ACM SenSys'03*, Los Angeles, CA, USA, Nov. 2003.



# Poster Abstract: Modular Communication Protocols for Sensor Networks

Olaf Landsiedel

Jó Ágila Bitsch

Katharina Denkinger

Klaus Wehrle

Protocol Engineering and Distributed Systems Group  
University of Tübingen, Germany

*firstname.lastname@uni-tuebingen.de*

## ABSTRACT

In this paper we present our ongoing work on modular communication protocols for sensor networks. Their modularity allows recomposing a protocol dynamically at runtime and adapting it to the changing needs of a sensor network. Compared to existing work, our componentization is fine grained and protocol independent, enabling a high degree of component reusability.

## 1. INTRODUCTION

Wireless sensor networks – consisting of small, often battery powered embedded nodes – are able to sense the environment in a distributed fashion and so accomplish tasks that previously were too complex or expensive. Sensor nodes can be deployed without network infrastructure and far away from human access: anywhere from the forest canopy [6] to the backs of zebras [5].

As it is difficult and expensive to maintain such distant deployments, a sensor network is expected to be autonomous and long-lived. Thus, the network is required to adapt to environmental changes as well as changes in the network topology, when nodes fail or cannot reach each other anymore, by reconfiguring the communications protocols and sometimes even the applications. Furthermore, during deployment the sensor network's needs can change, too, as data sampled by the sensor network influences follow up experiments.

In this paper we discuss the case of reconfigurable communication protocols for sensor networks and our ongoing work in this area. Furthermore, we argue that other components of the sensor network operating system do not require such an amount of flexibility. Thus, compared to the SOS [3] operating system we do not propose a modular scheduler or memory management.

The remainder is structured as follows: Section 2 discusses the case of modular communication protocols. Next, section 3 introduces our fine grained modules for protocol building. Section 4 discusses related work and section 5 concludes.

## 2. THE CASE FOR MODULAR PROTOCOLS IN SENSOR NETWORKS

In this section we motivate the use of modular and reconfigurable communication protocols in sensor networks, see fig. 1. Commonly sensor network deployment and maintenance consists of several steps: (1) The sensor network is deployed: Via flooding a sensor node determines its posi-

tion in the network and announces its existence to the surrounding nodes. (2) Based on its position in the network, various tasks are assigned to a node: while data collection and forwarding are commonly assigned to a huge number of nodes, selected nodes take care of data aggregation [4, 8] or act as routing beacons [1, 2]. (3) During deployment the conditions change. Due to node failure or other environmental influences – such as changing radio propagation – nodes take over tasks from other nodes. Furthermore, nodes are retasked based on data sampled in previous measurements to adapt their functionality to new upcoming needs.

Today's sensor node operating systems [7] and their applications are statically linked at compile time. This approach allows to use code optimization and resource facilitation analysis. However, all functionality that might be used during deployment needs to be compiled into the binary at compile time. Furthermore, updates while a sensor network is deployed become very costly, as a whole binary needs to be redistributed. Thus, modular communication protocols can be of high benefit for sensor networks.

## 3. THE MODULES

In this section we discuss the modules that are used to compose a communication protocol. When analyzing various communication protocols we identified the following key properties: (1) A module shall present protocol independent functionality, for example to set certain bytes in a packet. (2) A configuration string at runtime or compile time specifies the exact functionality, making a component protocol dependent. (3) All component interfaces (in- and out-ports) are standardized to ensure that components can be combined arbitrarily.

Based on these above described properties, we designed our modular communication protocols. The components can be grouped into five main groups: Source, sink, operational, validation and de-multiplex. In the source group are all components that emit packets into the protocol, i.e. the incoming network interface, the application, and timers which omit packets at certain intervals. Similar, the sink class represents outgoing network interfaces, the application and

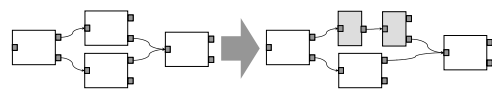
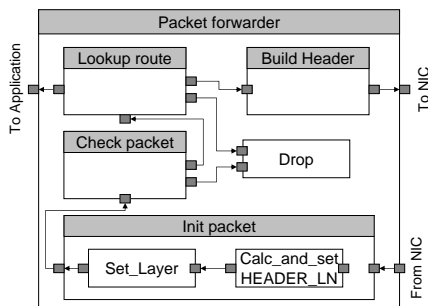

Figure 1: Modular and reconfigurable protocols allow for dynamic changes.



**Figure 2:** A packet forwarder build from compound and simple components

packet droppers. The operational components change the packet's header, payload or additional options like the outgoing device. Validation components check certain parts of a packet, based on the result they emit it to one of their outgoing ports. This class of components splits a packet flow into multiple flows. The de-multiplex component merges flows.

From these component classes we derived the individual components. Thus, each component has dedicated functionality which ranges from setting bits or bytes and computing a checksum to storing the system state in a so called black-board.

Compound modules are used to group components into functional and semantic groups. Compound modules are either protocol dependent or protocol independent. A protocol independent compound for example is a loop, which parses a packet for a certain bit or byte pattern. In the case of the IP protocol it can be used to parse for IP-options. Protocol dependent compounds are used to group functionality and make the protocol description more readable. A typical compound is a compound which builds a protocol header, see fig. 2.

To allow for easy component and protocol development, we have implemented a compiler and GUI which derive from a meta language the right modules to use and concatenate and configure these accordingly. Space limitations prevent us from discussing these features in more detail.

The work discussed in this paper is ongoing work. As today's sensor network protocols are kept quite simple, we derived our modules from the more complex Internet protocols, e.g. IP and TCP. Currently we use the modules derived from the Internet protocols to build sensor network protocols ranging from tree-based routing to data aggregation.

## 4. RELATED WORK

In this section we discuss the existing works on modular communication protocols and compare our work to them. Modular protocols have been previously presented for the use in the internet. Click [9] is a modular software router. However, most of the Click modules present IP specific functionality. In our approach modules are protocol independent, a configuration at run- or compile-time makes their behavior protocol specific. As result, our modules can be reused for various protocols. KIDS [10] provides a modular

QoS system, similar to Click it focuses on a certain protocol type, in this case on QoS functionality.

The Sensor Operating System (SOS) [3] introduces a modular operating system for sensor nodes. It allows to change major parts of the OS dynamically at run-time. However, from our point of view, OS components like the scheduler do not need to be changed at runtime. Thus, we propose a more lightweight approach. Furthermore, as our approach focuses on protocols only, it provides a more fine grained approach.

## 5. CONCLUSION

In this paper we presented our ongoing work on modular communication protocols for sensor networks. We introduced our fine grained approach to protocol independent modules which makes it applicable to wide range of different communication protocols.

Next to the implementation of various sensor network protocols our ongoing implementation efforts focus on two topics. First, it might be interesting to implement the modules on various platforms and even add a platform abstraction layer. Thus, the modules can be run on various systems. As a result, one can test a protocol by using modules implemented for a simulator and then use the same already evaluated and tested configuration for a sensor network. Furthermore, we consider it highly interesting to evaluate how protocol verification techniques can be applied to the meta language describing component configuration and concatenation.

## 6. REFERENCES

- [1] Q. Cao and T. Abdelzaher. A scalable logical coordinates framework for routing in wireless sensor networks. In *Proc. of IEEE RTSS*, 2004.
- [2] R. Fonseca, S. Ratnasamy, D. Culler, S. Shenker, and I. Stoica. Beacon Vector Routing: Scalable Point-to-Point in Wireless Sensor networks. In *Proc. of NSDI*, 2005.
- [3] C.-C. Han, R. Kumar, R. Shea, E. Kohler, and M. Srivastava. A dynamic operating system for sensor nodes. In *Proc. of MobiSys*, June 2005.
- [4] C. Intanagonwiwat, R. Govindan, and D. Estrin. Directed diffusion: a scalable and robust communication paradigm for sensor networks. In *Proc. of ACM MobiCom*, 2000.
- [5] P. Juang, H. Oki, Y. Wang, M. Martonosi, L. Peh, and D. Rubenstein. Energy-efficient computing for wildlife tracking: Design tradeoffs and early experiences with zebraNet. In *Proc. of ASPLOS*, October 2002.
- [6] W. Kaiser, G. Pottie, M. Srivastava, G. Sukhatme, J. Villasenor, and D. Estrin. Networked Infomechanical Systems (NIMS) for Ambient Intelligence. In *Invited contribution to Ambient Intelligence, Springer-Verlag*, 2004.
- [7] P. Levis et al. The Emergence of Networking Abstractions and Techniques in TinyOS. In *Proc. of NSDI*, March 2004.
- [8] S. Madden, M. J. Franklin, J. M. Hellerstein, and W. Hong. TAG: a Tiny AGgregation Service for Ad-Hoc Sensor Networks. In *Proc. of OSDI*, Dec. 2002.
- [9] R. Morris, E. Kohler, J. Jannotti, and M. F. Kaashoek. The Click modular router. In *Proc. of SOSP*, 1999.
- [10] K. Wehrle. An Open Architecture for Evaluating Arbitrary Quality of Service Mechanisms in Software Routers. In *Proc. of ICN*, 2001.

# Poster Abstract: Monitoring Indoor Temperature and Humidity for Pig Stables

Jens A. Hansen  
Centre for Embedded  
Software Systems, Dept. of  
Computer Science, Aalborg  
University  
Fr. Bajersvej 7B  
9220 Aalborg Ø, Denmark  
alsted@cs.aau.dk

Thomas D. Nielsen  
Machine Intelligence Group,  
Dept. of Computer Science,  
Aalborg University  
Fr. Bajersvej 7E  
9220 Aalborg Ø, Denmark  
tdn@cs.aau.dk

Henrik Schiøler  
Centre for Embedded  
Software Systems, Dept. of  
Control Engineering  
Fr. Bajersvej 7B  
9220 Aalborg Ø, Denmark  
henrik@control.auc.dk

## Keywords

Dynamic Bayesian Networks, Modeling, State Estimation, Fault Detection

## 1. INTRODUCTION

Animal production is basically the problem of getting a given number of animals from one stage in their growth cycle to the next. Today these stages are well defined for e.g. pigs[12], and the role of the farmer can be viewed as administering the animals growth plan. The fat/meat ratio of the pigs is a direct price parameter when they are brought to the slaughter house and it is therefore the farmers' concern that the fat/meat ratio is within a predefined interval with respect to some given mean and variance. During the growth cycle the climate is a major contributor to afore mentioned quality criteria.

The indoor climate in the stables is normally controlled by a climate computer. This computer regulates the climate based on two measurements, one of the relative humidity and one of the temperature. As actuators, the stable is normally normally outfitted with air outlets with fans placed in the roof of the building and air inlets placed on the sides of the building. Furthermore both water sprinklers and heaters can be fitted as actuators in stable[10].

The monitoring task of the indoor climate may include the task of fault diagnosis of both the actuation and sensory systems. Faults may be transient e.g. due to doors being opened for a period of time, or they may be persistent e.g. due to broken cables to the actuators.

Using Dynamic Bayesian Networks(DBN)[3], a model for a single zone stable is developed. The model is here after expanded with both transient and persistent fault models. Dynamic Bayesian Networks are well known for dealing with information processing, state estimation and fault detection[4, 6, 11, 9].

Dynamic Bayesian networks are related to hidden markov models and other probabilistic state space models such as the Kalman filter[7].

## 2. DYNAMIC BAYESIAN NETWORKS

Dynamic Bayesian Networks is a probabilistic graphical model used for modeling dynamic systems. Bayesian Networks uses conditional independence assumptions to construct efficient algorithms for inference[8, 5]. Dynamic Bayesian Networks does not share this property due to correlation of variables in the system[2] and therefore exact inference becomes intractable.

To represent larger systems approximative inference algorithms has to be used. One such is the Boyen and Koller algorithm, which relies on completely decoupling weakly interacting subprocesses at each discrete time slice[2].

More formally a DBN is a structure over a set of discrete stochastic variables  $\mathbf{X}$ , and is defined by a prior distribution  $\mathbb{P}(\mathbf{X}_1)$  over the first discrete time step and a transition model,  $\mathbb{P}(\mathbf{X}_{k+1}|\mathbf{X}_k)$  for all other time slices. The relation for the  $i$ 'th variable in  $\mathbf{X}$  at time  $k$  to  $k+1$  is specified using a Directed Acyclic Graph(DAG). Traditionally DBN's are completely specified using a Bayesian Network, this is also known as a 2TBN[7].

## 3. MODELING

The DBN's developed model a single zone stable. From an indoor climatic viewpoint a single zone stable can be understood as one unit, with a single set of sensors and actuators. The data used in the model was gathered at a test facility at Research Center Bygholm[1].

The main part of the model is the indoor temperature and humidity. The actuation consists of ventilation and heating. The ventilation couples the indoor climate to the outdoor equivalent.

The data used for the model includes both day and night fluctuation, this means the temperature is rising throughout the day and falling during night time. For greater precision the model includes a specification for day/night switching.

An error model for both persistent and transient sensor errors are included in the model. This can be interpreted as either the direct sensors errors or some abnormality in the stable. Both are conditions which should be discovered by the model.

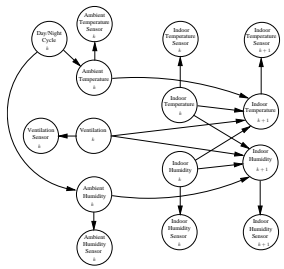

1: DBN model of the indoor climate for a single zone stable

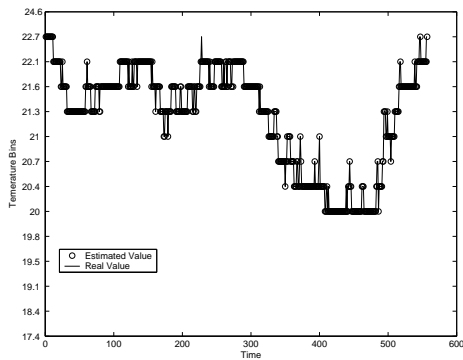

2: State estimation for the indoor temperature.

Figure 3 is the DBN modeling single zone stable. The heating actuation node and the ambient humidity and temperature at time  $k + 1$  has been removed to make the model more readable.

#### 4. TESTS

Several tests is conducted on the developed model to test the various features included in the model, these are

- Indoor climate state estimation
- Transient sensor errors
- Persistent sensor errors

The tests are made on a part of the data set that has been retained during the modeling. The data is used to construct tests that verifies if the model has the desired properties. Further more the number of time steps has some importance since the live stock in an actual stable only has a limited life time in extreme climate conditions.

In Fig: 2, a diagram with the real temperature and the estimated temperature is shown. The plot shows a strong correspondence between the actual and the estimated temperature.

#### 5. CONCLUSION

The presented work is the first to steps incorporate information processing, sensor fusion and fault detection in modern pig production. The model developed still requires some

tuning, but in general the model solves the problems for which it is designed. The use of the Boyen and Koller algorithm has been successful even though some problems occur when dealing with missing sensor readings.

#### 5.1 Future work

Our future work goes into using DBN's in a multi zoned setting for pig stables. The multi zone setting will push the size of the models in to an area where even the approximative algorithms may prove to be intractable. There fore some hierarchical ideas are to explored.

#### 6. ACKNOWLEDGEMENTS

We would like to thank Skov A/S for insight into the problems and processes related to climate control and censoring in pig stables.

#### 7. REFERENCES

- [1] Research centre bygholm  
<http://www.agrsci.org/content/view/full/822>, 2005.
- [2] X. Boyen and D. Koller. Tractable inference for complex stochastic processes. pages 33–42, 1998.
- [3] T. Dean and K. Kanazawa. A model for reasoning about persistence and causation. *Comput. Intell.*, 142–150:142–150, 1990.
- [4] N. Friedman, M. Linial, I. Nachman, and D. Pe'er. Using bayesian networks to analyze expression data. In *RECOMB*, pages 127–135, 2000.
- [5] F. V. Jensen. *Bayesian Networks and Decision Graphs*. Springer Verlag, 2001.
- [6] U. Lerner, R. Parr, D. Koller, and G. Biswas. Bayesian fault detection and diagnosis in dynamic systems. In *AAAI/IAAI*, pages 531–537, 2000.
- [7] K. Murphy. *Dynamic Bayesian Networks: Representation, Inference and Learning*. PhD thesis, UC Berkley, Computer Science Division, 2002.
- [8] J. Pearl. *Probabilistic reasoning in intelligent systems: networks of plausible inference*. Morgan Kaufmann Publishers Inc., 1988.
- [9] A. Singhal and C. Brown. Dynamic bayes net approach to multimodal sensor fusion. In *SPIE conference on Sensor Fusion and Decentralized Control*, volume 3209, Pittsburgh, PA, 1997.
- [10] Skov. Skov A/S  
<http://www.skov.dk/>, 2005.
- [11] R. Sterritt, A. Marshall, C. Shapcott, and S. Mcclean. Exploring dynamic bayesian belief networks for intelligent fault management systems, 2000.
- [12] C. Whittemore. *The Science and Practice of Pig Production*. Blackwell Science, 1998.

# Poster Abstract: A PIR based wireless sensor node prototype for surveillance applications

Piero Zappi, Elisabetta Farella, Luca Benini  
DEIS - University of Bologna  
v.le Risorgimento 2  
40136, Bologna, Italy  
{pzappi,efarella,lbenini}@deis.unibo.it

## ABSTRACT

This paper describes the design and implementation of a wireless sensor node, called WiPIR, targeted for integration into surveillance systems, traffic control and people or object tracking. The prototype mounts a Pyroelectric InfraRed (PIR) sensor, which is a low-cost, small-sized passive component. Wireless communication capabilities are based on the standard IEEE 802.15.4 MAC protocol, which provides network flexibility and reliability. The on-board microcontroller enables complex signal analysis and processing. We describe hardware-software architecture and WiPIR characterization in terms of power consumption.

## 1. INTRODUCTION

In recent years, wireless sensor networks (WSN) have become technically feasible thanks to the development of microelectronic system and wireless communication together with new technologies for compact and power efficient sensors. However, many technical hurdles have to be overcome to achieve a widespread diffusion of WSN technology. First, WSNs are strongly tied with the surrounding physical world, from where they continuously extract information, but without interfering with it in any way that is not specified by their function. This requirement can be met only if the node is very inexpensive, small, wireless, lightweight and self-powered.

PIR sensors are low-cost, low-power small sensors able to transduce variation of incident infrared radiation, due to movement of bodies not at thermal equilibrium with the environment, into electric signals. This propriety enables presence detection of humans, but also moving objects, in fact such sensors are widely used to trigger cameras [2], being very useful in limited light conditions [1]. Moreover, use of network of PIR leads to extraction of more complex data such as object direction of movements, speed, distance from sensor and other characteristics. Such information can be used in sensor fusion techniques to integrate an existing camera-based people-tracking system [3] or alone in private areas for security purposes, where privacy must be preserved [4]. Differently from previous work, our prototype exploits on-board processing capabilities to perform part of the signal analysis, to aggregate and combine data coming from different sensory units and send them on the wireless link. Furthermore, the network enables flexibility in terms of distribution of the processing tasks.

In this paper, we focus on presenting design and implementation of a low-cost, low-size, low-power, Zigbee compliant

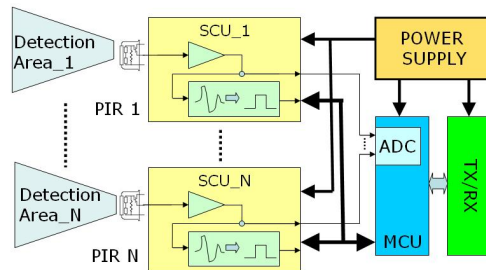

Figure 1: General architecture of WiPIR

PIR based sensor node called WiPIR (Wireless PIR). Being based on a standard protocol (IEEE 802.15.4) for communication, the WiPIR network can adopt different topology, establish nodes with different roles in the network and support dynamic node addition or removal. Coupling network architecture flexibility with on-board processing capabilities, WiPIR can be exploited not only as an alarm generator caused by threshold exceeding, but also as source of data stream processed distributely on the network for more complex environmental events capturing.

## 2. NODE ARCHITECTURE

The general architecture of a single node is shown in Figure 1. More than one PIR can be connected to the microcontroller unit (MCU) through the signal conditioning unit (SCU). Each PIR sensor is equipped with a Fresnel lens (Figure 2), which is used to shape the detection area while IR filter is used to limit incoming radiation between 8 and 14 $\mu$ m, typical of human body radiation range. By suitably shading its Fresnel lenses, for example, we were able to obtain cone of coverage with a vertical angle of 60 degree and an horizontal angle of 38 degree. The typical PIR output is characterized by few mV of maximum swing, therefore an operational amplifier is needed. Digital output is obtained through use of a programmable comparator, with I2C serial interface, where a threshold can be set. However, in our work analog output is also considered to extract more complex information than the simple presence.

The node is completed by microprocessor and transceiver (TX/RX) unit. The Freescale HCS08 family microcontroller (MG9S08GT60) processes data coming from PIR sensors, encapsulates them within headers and footers and passes

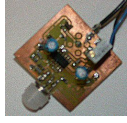

Figure 2: WiPIR sensor unit

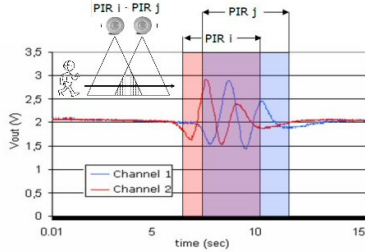

Figure 3: Signals detected by a node equipped with 2 sensor: activation sequence

them to the 2.4GHz transceiver (MC13192 by Freescale). Both transceiver and MCU are low-power components. The first is designed to be Zigbee compliant and at present is used with IEEE 802.15.4 communication standard. The second can operate in low-power mode and be awakened through external interrupt exploiting the digital signal coming from the PIR.

PIR output depends jointly on temperature, speed, direction, distance and object/person size in the detection area. Thus, aliasing may be significant: similar waveform could be generated by different combinations of the above parameters. Using more than one sensor can help distinguishing among two objects generating similar waveform (e.g. one small, warm and close to the sensor and one bigger, colder and more distant) on a single PIR, exploiting overlapping detection areas (see Figure 4). A similar setup or, in general, matrix of sensors can help improving robustness of the system, detecting changes of direction inside the area covered by the array of sensors, object size and shape through number of PIR activated, etc. On-board processing has been performed to detect direction change inside an area observed by two PIR sensors connected to the same node (Figure 3). PIR activation sequence reveals changes in direction of movement.

Communication among nodes has been developed using IEEE 802.15.4 protocol definitions for WSN, suitable for limited power budget and relaxed throughput requirements. Thus nodes can be organized with a star topology, where end-nodes communicate directly with a coordinator node.

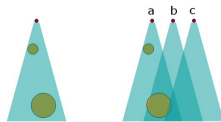

Figure 4: Distinguishing object with different characteristics with multiple PIR sensors



Figure 5: Packet structure

Field	Type	Size	Description
COP	int	1	Data/command packet code
Status	int	1	Status report byte
Node_ID	int	1	Sender or Receiver node Identifier (ID)
Length	int	1	Body field length
Body	int	0-65535	Data or commands
Handle	Int	1	Message ID

Table 1: Packet field description

The message exchanged among nodes depends on setup and application purposes, thus a flexible packet structure has been designed: a fixed set of bytes (headers and footers) encapsulates a variable number of bytes, the message body, which encode the information needed by the application. Table 1 and Figure 5 show the packet structure and meaning of each field. Messages can contain data or control commands.

### 3. SENSOR NODE CHARACTERIZATION

Table 2 shows power consumption of each component and of the whole node working at maximum packet rate, equal to 638 pps. The SCU includes one PIR sensor and its conditioning components. PIR contribution to power consumption is only 10  $\mu$ W.

Powering the system with 100 mAh battery the node lifetime is 2,5 hours of continuous activity due to detection of people moving in the coverage area. In real-life situation lifetime is increased by the fact that events are sporadic, as it has been verified in a practical case [3] with an earlier version of the prototype based on Freescale Evaluation board. Detectable speed of moving object is up to 7m/s, superior of typical moving speed of people. Sensitivity (difference between background and moving object) is 1,5 degrees.

Component	Power (mW)
SCU	1,23
MCU	19,5
TX/RX	111,0
Node (Active)	121,9
Node (Sleep)	3,36

Table 2: Power Consumptions (at Supply Voltage = 3,0 V)

### 4. REFERENCES

- [1] H.-W. B. P. Bryant. Some applications of a motion detecting camera in remote environments. *Technical Report*, February 2003.
- [2] <http://www.smarthome.com/7527MC.HTML>.
- [3] A. Prati, R. Vezzani, L. Benini, E. Farella, and P. Zappi. An integrated multi-modal sensor network for video surveillance. In *Proceedings of ACM int'l workshop VSSN '05*.
- [4] S. Rajgarhia, F. Stann, and J. Heidemann. Privacy-sensitive monitoring with a mix of ir sensors and cameras. *Proceedings of the Second International Workshop on Sensor and Actor Network Protocols and Applications*, pages 21–29, August 2004.

# Poster Abstract: Sensor Network for Corrosion Monitoring

Adrian Hozoi  
TNO Science and Industry  
P.O. Box 155  
2600 AD Delft  
+31 15 2692336  
adrian.hozoi@tno.nl

Zoltan Papp  
TNO Science and Industry  
P.O. Box 155  
2600 AD Delft  
+31 15 2692234  
zoltan.papp@tno.nl

Peter van der Mark  
TNO Science and Industry  
P.O. Box 155  
2600 AD Delft  
+31 15 2692336  
peter.vandermark@tno.nl

## ABSTRACT

This work describes a study for applying wireless sensor network technology and ultrasonic measurements to monitor the corrosion of installations in the oil and gas industry. Specific system aspects and design considerations are introduced, such as RF communication constraints. It is shown that implementing advanced measurements is feasible using efficient electronic instrumentation and power management.

## Keywords

Wireless sensor network, monitoring, ultrasound, corrosion, oil and gas industry.

## 1. INTRODUCTION

Industrial systems degrade as a function of time and inspecting their integrity is a critical task. To optimize the planning of maintenance and operation there is need for quasi-continuous monitoring combined with usage-based degradation models. The recent advances in wireless sensor network (WLSN) technology and affordable distributed computing open up new possibilities for continuous, on-line monitoring of industrial systems.

Miniature sensors with low power consumption, often based on MEMS technology, are available for measuring various parameters such as temperature, humidity, pressure, vibration, fluid level, flow rate, gas leakage, etc. However, inspecting the corrosion of industrial installations is still an issue and existing techniques are not suitable for wide coverage, quasi-continuous monitoring. The direct cost of corrosion affecting the economy in the United States alone is estimated at \$276 billion per year [1]. The oil and gas industry is one of the main sectors concerned, with high economical and safety impacts.

A measurement technique based on ultrasonic transducers is being researched at TNO Science and Industry for remote monitoring of corrosion wall loss. Corrosion is used here for simplicity to refer to a range of degradation mechanisms such as uniform or localized corrosion, erosion, environmental or stress cracking, etc. A preliminary study has been carried out and first experiments are being prepared. The method is expected to allow wide coverage and high resolution measurement of corrosion in pipelines, vessels, or other pressurized equipments. In this work, we describe technical challenges related to the development of a wireless sensor network for monitoring the corrosion of industrial assets. The discussion is focused on the case of pipeline inspection, related system constraints, electronic design, and power management.

## 2. SYSTEM OVERVIEW

Pipelines are used in the oil and gas industry in a variety of diameters (100 - 1500 mm), length, wall thickness (5 - 50 mm), materials, and construction. They can be aerial or buried under soil, water, or concrete. For example, a petrochemical plant may comprise over 3000 km of pipeline, much of which is inaccessible. Some of these pipelines are horizontal, some are vertical, some are up to 60 m high, and some are buried; they have bends, joints, and welds. The temperature ranges from ambient to 100°C and in some cases even up to 200°C or more. The pipelines are often surrounded by a thermal insulation layer (e.g. 100 mm thick) covered by a metallic shield which prevents water infiltration.

In order to ensure wide monitoring coverage, the ultrasound sensor nodes introduced here should be placed along pipelines at a spacing between 1 m to 3 m. Due to their dense distribution, it is preferable to mount the nodes within the thermal insulation layer and avoid making openings in the outer metallic shield (e.g. for antennas). Wireless communication among nodes must thus be performed along the pipeline through the insulation layer between the pipe and the metallic shield. The shield limits the electromagnetic transmission to the pipeline direction and causes attenuation, making the use of a high frequency band recommended (i.e. 2.4 GHz, IEEE802.15.4, 250 kb/s). A multi-hop routing scheme will be employed to transmit the data along pipelines. The hopping distance should be maximized over several nodes, as a compromise between electromagnetic signal integrity and power consumption. It is expected that a transmission range above 5 m is achievable within the insulation layer of a straight pipe, experimental evaluation of the link being planned. Using a directional antenna to radiate the highest power along the pipeline direction would improve the efficiency of the RF communication. Gateway nodes will be used to link the pipe communication path with the outside world. They can be placed at the extremities of the pipelines, at junction levels, or along the pipelines at convenient locations.

The monitoring technique being developed at TNO would allow identifying and measuring corrosion spots based on ultrasonic waves' propagation. In the preliminary design, up to 32 piezoelectric transducers are connected to a WLSN node. The node consists of a commercially available wireless module (mote) and a specific ultrasound sensor board. The Tmote Sky mote, based on the Telos Revision B design, was selected due to its high performance, very low power, and TinyOS support [2]. The sensor board contains the electronics necessary to address all 32 piezoelectric transducers for pulse generation, signal detection

and processing. The board comprises a generator circuit, multiplexer, read amplifier, ADC, and an extremely low power DSP (ADSP-BF532, 0.25 mJ/MMAC) as sketched in Figure 1. Measurement signals are sensed by 8 parallel channels, each having a sampling rate of 10 MS/s. The complete raw measurement set amounts to 1 MB generated at high speed up to 640 Mb/s, which is far too high for being directly transferred to the mote. The DSP features superior processing speed and efficiency compared to the mote's microcontroller, achieving enhanced performance and lower power consumption. The processed result is transferred to the mote through a standard serial interface (UART or SPI). The mote must thus deal with reduced amounts of data and can be better optimized for its networking tasks within the WLSN. A node would generate a result set around 20 kB to be transmitted across the network toward a gateway. The energy spent by a node to acquire, process, and transmit a measurement set is estimated below 300 mJ, of which only 12 mJ are for the acquisition. Generating the corresponding ultrasonic waves would require less than 45 mJ.

Routing the data across the WLSN will inevitably require superior participation of the nodes located in regions with traffic congestion (e.g. proximity of gateways, pipe bends). Transferring large amounts of measurement data may cause these nodes to run out of power prematurely. Receiving and transmitting a 20 kB result set would require around 80 mJ, assuming a packet yield of 90% and sustained data rate of 225 kb/s. The energy spent by a congested node with multi-hop traffic converging from 50 nodes would amount to 4000 mJ. Routing the measurement results is the most power demanding activity. It is therefore important to minimize the size of the result data by efficient local processing and to optimize the networking protocols for low power consumption, evenly distributed among the nodes. A good balance must be achieved between data transmission, local processing, reliability, power consumption, accuracy, cost, etc.

Corrosion is a rather slow process and continuous monitoring could mean one measurement in three days, achieving a low duty cycle around 0.05%. Still, the nodes must be operational for more than 10 years on battery power (e.g. two AA size batteries). The average current drawn by a congested node is close to 15  $\mu$ A, making operation for 10 years conceivable even on a single AA lithium battery like the LS-14500 (Table I). A pair of two AA batteries (e.g. 2 x L91 in series, or 2 x LS-14500 in parallel) or a single C size battery would provide an operating time around 15 years. It would moreover allow to increase the duty cycle and to fit the nodes with additional monitoring functions such as temperature, humidity, vibration, and gas leakage. Lithium batteries feature high capacity, low leakage currents and achieve long lifetime with consistent performance under wide temperature range. Lithium-thionyl chloride (Li-SOCl<sub>2</sub>) batteries have the highest energy density and can operate at high temperatures up to 150°C. Lithium poly-carbon monofluoride (Li-(CF)<sub>n</sub>) batteries offer similar performances but are not available in AA size. Renewable energy sources can be considered for operation above 15 years; however, they must be robust and free of maintenance. Thermoelectric conversion is an attractive choice for energy scavenging via heat transfer, e.g. between pipes and the outer shield. The efficiency of thermoelectric modules depends on the temperature gradient, varying around 0.1% to 1% for a difference of 3°C and 30°C respectively.

### 3. CONCLUSION

Preliminary studies indicate that the development of a wireless sensor network for corrosion monitoring would be possible using advanced ultrasonic techniques. High performance electronic instrumentation was designed for long operating time beyond 10 years on battery power, enabled by very low duty cycle and efficient data processing and transmission. Validation experiments are being prepared and fitting the nodes with other monitoring functions is considered to meet additional needs of users.

**Table I. Typical characteristics of AA size, high performance alkaline and lithium batteries.**

Battery	Energizer X91	Energizer L91	Saft LS-14500	Sonnens. SL-560
Chemistry	Zn-MnO <sub>2</sub>	Li-FeS <sub>2</sub>	Li-SOCl <sub>2</sub>	Li-SOCl <sub>2</sub>
Temp. range	-20°C to 55°C	-40°C to 60°C	-60°C to 85°C	-55°C to 130°C
Voltage	1.5 V	1.5 V	3.6 V	3.6 V
Capacity	2.6 Ah (to 1.0 V)	3.0 Ah (to 1.0 V)	2.25 Ah (to 2.0 V)	1.7 Ah (to 2.0 V)
Energy	11 kJ	16 kJ	28 kJ	21 kJ
Current	25 mA	200 mA	2 mA	2 mA
Pulse current	2 A (for 2 s)	3 A (for 2 s)	280 mA (for 0.1 s)	50 mA (for 0.1 s)
Lifetime at 20 $\mu$ A	7 - 10 yr (at 21°C)	12 - 15 yr (at 21°C)	9 - 10 yr (at 21°C)	6 - 7 yr (at 85°C)
Price	€ 0.4	€ 2	€ 3.5	€ 6

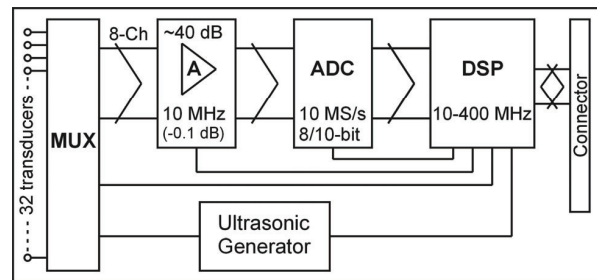

**Figure 1. Block diagram of the ultrasound sensor board.**

### 4. REFERENCES

- [1] Kokh, G. H., et al. *Corrosion Cost and Preventive Strategies in the United States*. Report FHWA-RD-01-156, Federal Highway Administration, McLean, VA, 2001.
- [2] Polastre, J., et al. Telos: Enabling Ultra-Low Power Wireless Research. In *Proceedings of the Fourth International Conference on Information Processing in Sensor Networks (IPSN/SPOTS)*, Los Angeles, CA, April 25-27, 2005.



# Poster Abstract: Security and Advanced Control Issues in a Robotic Platform for Monitoring and Relief

Antonio Danesi  
Centro Interdipartimentale di  
Ricerca "E. Piaggio"  
Università di Pisa  
Pisa, Italy

antonio.danesi@ing.unipi.it

Ida M. Savino  
Dipartimento di Ingegneria  
dell'Informazione  
Università di Pisa  
Pisa, Italy

ida.savino@iet.unipi.it

Riccardo Schiavi  
Centro Interdipartimentale di  
Ricerca "E. Piaggio"  
Università di Pisa  
Pisa, Italy

riccardo.schiavi@ing.unipi.it

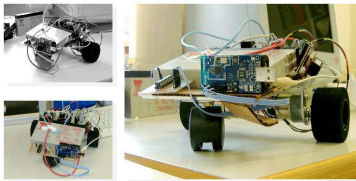

Figure 1: RAIN agent prototype layout.

## ABSTRACT

This paper provides an architectural overview and a first implementation of an heterogeneous agent network composed by mobile robots of different scale and purposes able to establish a secure group connection among them and with the fixed infrastructure. A road tunnel patrolling and first relief application has been issued.

## 1. INTRODUCTION

This poster will provide an overview of the architecture we are developing according to the *Tunnel Disaster Scenario* studied in the context of EU-funded RUNES project (<http://www.ist-runes.org>). The architecture consists of autonomous mobile robots moving along a road tunnel for cars and trucks, collecting data and reacting to emergencies in order to provide first relief services to people and goods. The robotic platform is supported by a fixed tunnel infrastructure that provides cameras and video elaboration along the tunnel, collects data from robots and coordinate actions. Two kinds of robots move and survey the environment: *GaIN* (Gateway Infrastructure Network) agents are camera-equipped mid-size mobile robots and *RAiN* (Robotic Aided Networking) agents are small size inexpensive mobile systems with low-cost sensors as (fig.1). These agents form with the tunnel infrastructure an heterogeneous mobile sensor and actuator network. Control issues in this architecture involve the study of distributed algorithms to efficiently cover the road tunnel during patrolling, obstacle avoidance and wireless network coverage maintenance via mobile agents. We made particular efforts to realize RAIN platforms as the cheap sensor/actuator nodes. The core of the architecture of the small agent comes from integrating the Tmote Sky sensor node with a PSoc microcontroller to control drivers and collect odometry data of the small vehicle. A crucial issue for mobile robots is absolute localization, in our work we adopt vision as main technol-

ogy. RAIN agents don't have sensors to identify absolute position. Road tunnel fixed cameras can identify agents by visual marks placed on their chassis and calculate their absolute positions. On the other hand, GaIN agents can localize themselves by means of tunnel graphic marks. Furthermore, they have responsible for localizing RAIN when they appear to be in areas not covered by fixed cameras.

The RAIN and GaIN agents cooperate toward the distributed control task according to the *group communication* model. In this model, a mobile agent becomes a new member of the group by explicitly joining it (i.e., at tunnel entrance). As a member of the group, the agent may broadcast messages to the other members. Later on, the agent may voluntarily leave the group, or, if compromised, may be forced to. After that event, the agent cannot send messages to, or receive messages from, the group. From a security perspective, the agents form a wireless network that is vulnerable to serious attacks. Actually, it must be avoided that adversaries, equipped with a simple radio receiver/transmitter, easily eavesdrop conversations or inject/modify packets thus compromising the agent network.

## 2. ARCHITECTURE

We simulate the road tunnel environment with our lab equipment. A fixed camera connected to a PC performs as the fixed infrastructure of the tunnel, capable to store data, elaborate orders to mobile platforms and furnish localization services. The GaIN agents are built over commercial mobile robots, *Koala*, equipped with a laptop pc and camera. These agents have enough computational capabilities to implement algorithms to navigate known and unknown environments while building and updating maps. RAIN agents are built on a 802.15 wireless sensor network node, communicating with a microcontroller that drives two actuators to move the agent. They can extend their communication ranges simply moving. In case of detaching of portions of tunnel, these agents can be used to reestablish connectivity.

## 3. HARDWARE INTEGRATION

GaIN agents have a classical solution of Pentium boards that control middle size robotic platforms and elaborate camera sensor data. Layout of RAIN agents have been designed for functionality despite extreme low cost. Tmote Sky boards already implement 802.15 protocol and the board has programmable CPU and sensors. PSoc microcontrollers have versatility and programming tools. The board we implemented ties these CPU's over RS232 link. PSoc drives two

motors able to move RAiN agent as an unicycle with speed or position reference. Tmote Sky can make the agent to follow a desired path programming the PSoC to implement a proper control on motors.

#### 4. VISUAL LOCALIZATION AND COLLISION AVOIDANCE

GaIN agents patrol environment using our Visual SLAM for Servoing (VSLAMS) algorithm that perform localization and map building with visual servoing techniques [1]. This makes GaIN agents able to dynamically update maps with changes and perform safe path planning in known environment. Infrastructure and GaIN agents perform visual recognition of marks over chassis of agents. Techniques involved in video processing are SIFT (Scale Invariant Feature Transform) decompositions [4], contour analysis and homographic projections. Each RAiN agent can ask for a localization service to the infrastructure and to GaIN agents, sharing the visual informations able to identify univocally one vehicle. In order to avoid collisions among the RAiN agents a decentralized cooperative algorithm has been studied in our lab [5] and implemented dealing with limitations in hardware computation capabilities. Secure connections on localization services are necessary not to be subject to tampering action.

#### 5. SECURITY

In order to protect group communication, RAiN and GaIN agents share a symmetric *group-key*. Techniques based on public key cryptography, e.g., digital signatures, that are usually used to achieve broadcast authentication in traditional wired networks, cannot be used. Hence, the agents use the group-key to encrypt messages broadcast within the group so that anyone that is not part of the group can neither access nor inject/modify messages. This solution is complicated by the fact that the group membership may change. New agents can *join* the group after the deployment of the application, whereas an agent *leaves* the group when it has terminated its mission. Besides, agents are particularly exposed to the risk of being compromised and thus it may be necessary to force them to leave the group. When a new agent joins the group, that agent must not be able to decipher previous messages encrypted with an old key even though it has recorded them (*backward security*). When an agent leaves, or is forced to leave, the group, the agent must be prevented from accessing the group communication (*forward security*). In this model, forward and backward security are provided via rekeying. When a member joins or leaves the group, a new group-key must be distributed in order to guarantee both backward and forward security. In large and/or dynamic groups, this *reactive* approach to group-key management may incur in high rekeying overhead. Nevertheless, the approach has the advantage that a new node can immediately join the group and a compromised member can be promptly forced to leave as soon as it is discovered. Due to the severe resource limitations of agents, the rekeying protocol must aim at a trade-off between security and resource consumption. For these reason we adopt a secure and scalable rekeying protocol that levers on two basic mechanisms [2]: key-chains, a lightweight authentication mechanism based on the Lamport's one-time passwords [3], and a Logical Key Hierarchy (LKH), a tech-

nique for secure and scalable group rekeying [6]. In brief, LKH allows us to reduce the communication overhead by reducing the number of rekeying messages. Upon receiving new keys without additional overhead (i.e., signature), every agent is able to immediately verify its authenticity by means of hash functions.

#### 6. CONCLUSIONS

In this poster we provided an overview of a secure and advanced robotic architecture. We have shown an implementation of robotic sensor network, where heterogeneous mobile robots patrol using visual feedback and secure group communication.

#### 7. ACKNOWLEDGMENTS

The work of undergraduate students Alessandro Convalle, Lorenzo Decaria, Isidoro S. La Porta is gladly acknowledged.

#### 8. ADDITIONAL AUTHORS

Additional authors: Antonio Bicchi (Centro Interdipartimentale di Ricerca "E. Piaggio", Università di Pisa, email: [bicchi@ing.unipi.it](mailto:bicchi@ing.unipi.it)) and Gianluca Dini (Dipartimento di Ingegneria dell'Informazione, Università di Pisa, email: [gianluca.dini@unipi.it](mailto:gianluca.dini@unipi.it)).

#### 9. REFERENCES

- [1] A. Danesi, D. Fontanelli, and A. Bicchi. Towards cooperative visual-based localization, mapping, and servoing. 2004. Proc. IEEE Mediterranean Conf.
- [2] G. Dini and I. Savino. Scalable and secure group rekeying in wireless sensor networks. *Proc. IASTED PDCN*, February 2006.
- [3] L. Lamport. Password authentication with insecure communication. *Communications of the ACM*, 24(11):770–772, November 1981.
- [4] D. G. Lowe. Object recognition from local scale-invariant features. *International Conference on Computer Vision*, pages pp. 1150–1157, September 1999.
- [5] L. Pallottino, V. G. Scordio, E. Frazzoli, and A. Bicchi. Decentralized cooperative conflict resolution for multiple nonholonomic vehicles. In *Proc. AIAA Conf. on Guidance, Navigation and Control*, page (in press), 2005.
- [6] C. K. Wong, M. G. Gouda, and S. S. Lam. Secure group communications using key graphs. *IEEE/ACM Transactions on Networking*, 8(1):16–30, February 2000.

# Poster Abstract: Experimental Localization Results in an Indoor Wireless Sensor Network Testbed

Sebastiaan Blom  
Dept. of Information Eng.  
(DEI) University of Padova  
35131 Padova Italy

sebastiaan.blom@gmail.com

Matteo Andretto  
Dept. of Information Eng.  
(DEI) University of Padova  
35131 Padova Italy

andretto@dei.unipd.it

Andrea Zanella \*  
Dept. of Information Eng.  
(DEI) University of Padova  
35131 Padova Italy

zanella@dei.unipd.it

## ABSTRACT

Localization in wireless sensor networks has been, and still is, an interesting research topic. Despite the great interest that this topic has drawn in the research community, the solutions proposed in the literature often reveal their limits when realized in practice. While simulations are easier to implement they do not capture the real world enough. On the other hand practical implementations are more difficult and experiments are time consuming and difficult to debug. Therefore a proper testbed that allows quick testing in a real environment is required. The work we describe here is two-folded: first, we briefly describe our indoor testbed and the related testbed management software. Secondly we describe the implementation of an improved range-free localization scheme and provide both simulation and experimental results.

## 1. INTRODUCTION

Localization in Wireless Sensor Networks (WSN) is both an interesting service that can be offered by the network to the users for different purposes and a very powerful tool that can be exploited in the design of algorithms to run the networks itself. Clearly, these aspects make the definition of effective localization mechanisms a very attractive research topic, which has driven to the proposal of several solutions in the last years. Generally speaking, localization protocols may be classified by the information used to estimate position. In range-based protocols, a node uses estimates of the range or angle from its neighbors to compute its own position. When nodes have no capability for computing such estimates, the corresponding solutions are called range free [3].

In this work we focus on a combination of these techniques. First a range-free localization mechanism, using RSSI (Receiver Signal Strength Indicator), is used to make a first position estimation. Note that it does not convert RSSI to distance and therefore is considered range-free. Secondly an (optional) range-based technique is used for refining the results.

Previous experiments in this direction have revealed that RSSI does not allow a fine localization, even after long and precise calibration. This is due essentially to the unpredictability of the radio channel dynamic. Furthermore, en-

\*Contact Author: Phone: +39 049 8277770; Fax: +39 049 8277699. This work fits in the framework of the European project Embedded WiSeNts ([www.embedded-wisents.org](http://www.embedded-wisents.org)).

ergy level has impact on the transmission power of a node [1] so that the calibration process becomes rapidly loose when nodes progressively discharge their batteries. Nevertheless it is an attractive technique since mechanisms based on the comparison of the time of flight of impulses with different propagation speeds usually require either cumbersome and energy expending equipment and are still prone to errors due to environmental noise.

The original contribution of this work is, hence, the definition of an improved version of an RSSI-based localization algorithm and its comparison with the original algorithm through a real test-bed.

In Section 2, we briefly describe the hardware and software of our indoor test environment. In Section 3 the implemented localization algorithm is described. In the subsequent section some simulation and experimental results regarding the proposed indoor localization algorithm will be presented. Finally, in Section 5 the conclusions of our work are drawn.

## 2. TESTBED

Goal of the testbed is to provide an environment which allows quick and easy testing of, for example, routing and localization algorithms for WSNs. The constructed network consists now of 32 nodes which are hang up at a rope grid, located 60 cm under the laboratory ceiling. The average distance between two neighbor nodes along a rope is 118 cm whereas the distance between two ropes is 170 cm. To be able to send commands, collect information from sensors, distribute power (instead of batteries), we have used USB hubs that link each node to a central PC by USB cables. The testbed is realized with EYESIFXv2 sensor nodes, produced by Infineon, equipped with a Texas Instruments MSP430 CPU and an Infineon TDA5250 radio. Nodes support TinyOS operating system, while the PC runs a Java application that has been developed to manage the network. Features include a graphical representation of the network, programming a selection of nodes, sending commands and logging data.

## 3. LOCALIZATION METHOD

The testbed has been used to test several localization schemes, including the well known Lateration and MinMax algorithms. In all the cases, RSSI has been used to estimate the range. The mapping between RSSI and distance has required an extensive and time-expensive calibration phase. Nonethe-

less, real-time RSSI measurements show large variations that lead to very noisy range estimations. Hence, the RSSI-ranging has proved to be the major weakness of these range-based algorithms. To partly overcome these problems we have chosen to implement a range-free algorithm, called *Ring Overlapping based on Comparison of Received Signal Strength Indicator* (ROCRSSI)[2]. ROCRSSI has a low communication overhead and requires only the beacons to transmit messages. Basically, each beacon periodically broadcasts a vector with an entry for any other beacon in its coverage range. The entry reports the beacon coordinates and the RSSI of the signal received from that beacon. The tagged node, hence, can compare the contents of such vectors with the RSSI of the signal that it gets from the different beacons. This permits the node to determine series of overlapping rings to narrow down the possible area in which it resides. Then it calculates the intersection area of these rings (or circles) and takes the gravity of this area as its estimated location (see [2] for further details).

In this work we propose a slightly improved version of this algorithm, henceforth called ROCRSSI+. First, in ROCRSSI+ a node consider also the outer part of the rings as a possible intersection region. This is possible in indoor environment, assuming that the area borders are known. This simple modification leads to improved results, as it will be shown in the next section. Furthermore, an iterative refinement procedure has been implemented on the top od ROCRSSI+. The goal of the refinement is to pull the estimated positions from the gravity point of the area towards their real position.

## 4. EXPERIMENTAL RESULTS

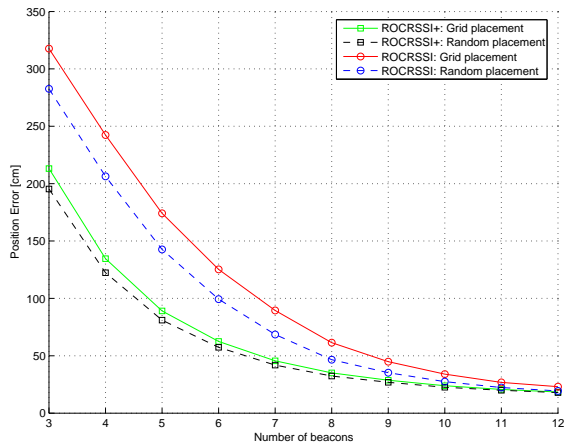

Figure 1: Localization error vs the number of beacons.

This section provides simulation and experimental results of the indoor localization algorithms described in the previous section. A simulation comparison between ROCRSSI and the improved version here presented, ROCRSSI+, can be observed in Figure 1. In this simulation, a total number of 121 nodes (both beacons and nodes with unknown location) are equally distributed in a  $10 \times 10$  m area. For both the algorithms, simulations have been executed with either the beacons placed in a grid or in an uniform random way. The

average location error has been averaged over five hundred runs. It can be seen that ROCRSSI+ outperforms the original algorithm. Further, it can be observed that, as expected, the number of beacons has a great impact on the localization accuracy. However, a floor on the estimation accuracy can be observed after a certain number of beacons. This helps determining the performance bounds of the localization algorithms and the number of beacons required.

number of beacons	ROCRSSI standard				ROCRSSI plus			
	No ref.		Ref.		No ref.		Ref.	
	avg.	std. dev.	avg.	std. dev.	avg.	std. dev.	avg.	std. dev.
3	437	216	294	148	427	210	279	162
4	414	245	240	282	402	266	250	179
5	403	254	285	189	388	217	252	167
6	338	203	216	116	280	170	213	106
4(corner)	563	220	554	282	471	261	507	234

Table 1: Indoor localization results, average and standard deviation error (50 square meters, 32 nodes, unit measure cm).

Table 1 shows the experimental results obtained by deploying the ROCRSSI and ROCRSSI+ in our testbed, before and after the refinement. The experiment has been repeated with various number of beacons. We can observe that the estimation errors measured in the real testbed are much higher than those estimated through simulations, thus confirming that real experimentation of the algorithms is needed. The estimation error decreases as more beacons are used. The last row of the table refers to a displacement of four beacons on the corners of the room. As it can be seen, the estimation errors are higher in this case, thus confirming that the environmental conditions have a great impact on the performance of the algorithms.

## 5. CONCLUSIONS

In this poster we presented a first experimental campaign regarding the performance of the ROCRSSI and its improved version, ROCRSSI+, localization algorithms. In the practical experiments performed with the testbed equipped in our lab, ROCRSSI+ showed an improvement of about 32% for the average error and 25% for the standard deviation.

## 6. ADDITIONAL AUTHORS

Michele Zorzi, Simone Friso and Riccardo Crepaldi (emails: {zorzi, anemos}@dei.unipd.it, crepric@gmail.com).

## 7. REFERENCES

- [1] S. Blom et al. Transmission power measurements for wireless sensor nodes and their relationship to the battery level. In *IEEE ISWCS 2005*, Siena, Italy, September 2005.
- [2] T. H. Chong Liu, Kui Wu. Sensor localization with ring overlapping based on comparison of received signal strength indicator. In *Proceedings of the 1st IEEE international Conference on Mobile ad-hoc and sensor system (MASS04)*, Fort Lauderdale, Florida, October 2004.
- [3] A. Zanella and M. Zorzi et al. Paradigms for algorithms and interactions. White paper, Embedded WiSeNts project, 2005.

# Poster Abstract: A Complete Energy Model for Wireless Sensor Networks

Lasse Öberg  
Data Communication, School Of Engineering  
Jönköping University  
SE-551 11 Jönköping, Sweden  
lasse.oberg@ing.hj.se

Youzhi Xu  
Data Communication, School Of Engineering  
Jönköping University  
SE-551 11 Jönköping, Sweden  
youzhi.xu@ing.hj.se

## ABSTRACT

Advances in both micro electronics and wireless communication technology has made it possible to develop and manufacture low cost and energy efficient sensor nodes. To compare and design different protocols with respect to the energy consumption a complete energy model is needed. In this paper we propose a complete energy model for wireless sensor networks that uses four operation states. This energy model also takes into account the transitions between different operation states, such that the energy consumption and the latency in different cases can be more accurately estimated for the sensor node. The transition times can be used to more accurately control different algorithms and protocols which will even further improve the energy efficiency. Other energy models proposed is to our best knowledge either targeted towards specific application needs or are not as accurate, in terms of the energy consumed, as the proposed model.

## 1. INTRODUCTION

The research activity in wireless sensor networks (WSN) has recently started to increase rapidly as it has gained popularity due to recent advances in the areas of micro-electronics and wireless communication technology. The areas of interest ranges from hardware- to software- design, where the focus in hardware areas includes subjects such as energy efficient and cheap battery-, sensor-, and communication-technology, and the software design focus lies in subjects like communication protocols, distributed signal processing, operating systems etc. The main objective of WSNs is to be able to collect and distribute information in a wide range of environments. This includes environments where there is no fixed communication infrastructure. Thus a sensor node needs to be able to communicate wireless, monitor its surrounding, and have computation and storage capabilities. The WSN as a whole need to be self-configuring, fault tolerant, and adaptive to its surrounding. To accomplish this the basic sensor node architecture consists of four subsystems: 1) A sensing subsystem with its associated sensor(s) and analog-to-digital converter (ADC), 2) A processing subsystem that consists of a micro controller unit (MCU) and memory unit, 3) A communication subsystem with a radio transceiver, and 4) A power supply subsystem that provides the other components with energy. All these subsystems are then controlled by the operating system using the appropriate drivers, protocols and algorithms. The basic sensor node architecture can be extended with additional subsystems that provide the sensor node with added capabilities

**Table 1: The four operation states used in this energy model for wireless sensor networks.  $T_x$  = transmit,  $R_x$  = receive**

Operation State	Sensor	Processing	Communication
1: Sleep	Off	Off	Off
2: Sense	On	Off	Off
3: Receive	On	Active	$R_x$
4: Transmit	On	Active	$T_x$

like location awareness, mobility, energy replenishing systems, etc.

## 2. THE PROPOSED ENERGY MODEL

The proposed energy model has a three layer hierarchical structure which can be presented by the use of four different operation states shown in Table 1 and the state transition diagram shown in Figure 1. The four operation states used are: (1) the sleep state, (2) the sense state, (3) the receive state, and (4) the transmit state. The last two states are very similar, since the main difference between them are the functions performed by the processing subsystem and the communication subsystem (frequency synthesiser, modulation, demodulation, etc.). The four operation states energy consumption is further described in section 2.1. In section 2.2 the energy consumed during a transition between two of states are presented, and Section 2.3 describes how the total energy consumed for a sensor node is calculated using this energy model.

### 2.1 Energy consumption at the operation states

The energy consumption in each operation state depends on the activity of each subsystem and the time spent in that operation state. We now define the concept of a visit as the time period between the arrival and the departure at operation state,  $i$ . Since the time for each visit in operation state  $i$  can vary, the total accumulated time,  $T_i$ , in operation state  $i$  is divided into a number of visits. Let  $\tau_{i,k_i}$  denote the time spent in operation state  $i$  during the  $k_i^{th}$  visit in that state, and thus  $T_i = \sum_{\forall k_i} \tau_{i,k_i}$ . The energy consumed during one visit to operation state  $i$  can be obtained as

$$E_{i,k_i} = P_i \tau_{i,k_i} \quad (1)$$

where  $P_i$  is the power expended during operation state  $i$ , and the description of how to obtain  $P_i$  for the four operation states is presented below.

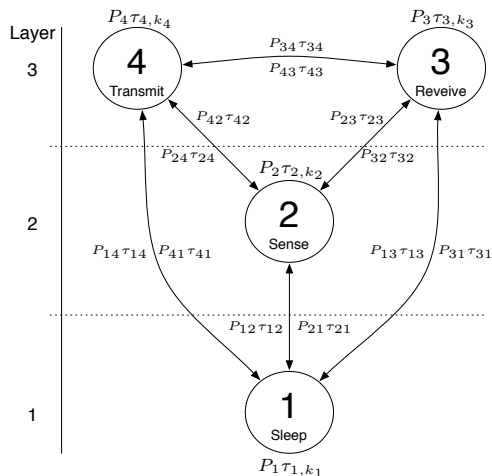

**Figure 1: State transition diagram of the complete energy model.**  $P_{ij}$  is the power consumed and  $\tau_{ij}$  is the time spent in transition between operation state  $i$  and  $j$ .

In the sleep state the sensor nodes are in a state of hibernation, where all subsystems are turned off. The power expended in this state for a sensor node is obtained as follows

$$P_1 = P_{leakage} + P_{timer}$$

where  $P_{leakage}$  is the average power leakage, and  $P_{timer}$  is the average power consumed to operate the timer circuits. In the sense state the main activity of a sensor node is to sense its surrounding and to store the collected data for further processing. The power consumed by a sensor node in this operation state is

$$P_2 = P_{sense} + P_1$$

where  $P_{sense}$  is the average power consumed by the sensor subsystem. In the receive state the major power expended is due to that the receiver electronics in the radio subsystem is active. Thus the power consumed can be calculated as follows

$$P_3 = P_{pr} + P_{Rx} + P_2$$

where  $P_{pr}$  is the average power consumed for an active processing subsystem,  $P_{Rx}$  is the average power expended by the receiver electronics. In the transmit state the power consumed is mainly due to the large power requirements of the transmitter electronics and the transmit amplifier in the communication subsystem. The energy expended by the sensor node during one visit to this operation state is

$$E_{4,k_4} = P_4\tau_{4,k_4} + P_{amp}(d_{k_4})\frac{l_{k_4}}{R_c} \quad (2)$$

and  $P_4$  can be obtained as

$$P_4 = P_{pr} + P_{Tx} + P_2$$

where  $P_{Tx}$  is the power consumed by the transmitter electronics,  $P_{amp}(d_{k_4})$  is the power consumed by the transmit amplifier with distance  $d$  to the receiving node,  $l_{k_4}$  is the number of bits transferred, and  $R_c$  is the channel bit rate.

## 2.2 Energy consumption at the transition states

During a transition period subsystems are activated or deactivated. To model this change in power consumption, we have simplified the actual power consumption characteristics during a transition with the assumption that the power consumption changes according to a symmetric and linear function, between the two power consumption levels at state  $i$  and  $j$ . In reality the power consumption during a transition depends on the actual components used and it is different for both activation and deactivation of a subsystem. Our simplified assumption implies that  $P_{ij} = P_{ji}$  and that the average power consumption can be calculated as follows

$$P_{ij} \approx \frac{P_i + P_j}{2}$$

The transition times  $\tau_{ij}$  and  $\tau_{ji}$  usually differ, where the activation time of a subsystem are usually longer than the deactivation time of the same subsystem. The total accumulated time spent in transition between operation state  $i$  and  $j$  can be calculated as follows  $T_{ij} = m_{ij}\tau_{ij}$ , where  $m_{ij}$  is the number of transitions from state  $i$  to  $j$ . The energy expended in the transition states are

$$E_{ij} = P_{ij}T_{ij} = P_{ij}m_{ij}\tau_{ij} \quad (3)$$

where  $P_{ij}$  and  $\tau_{ij}$  are constant for the specific sensor node.

## 2.3 Total energy consumption

The energy consumed,  $E$ , in a sensor node over a time period,  $T$ , using this model is expressed in equation (4) below and is obtained from equations (1), (2), and (3).  $E$  depends on the energy consumed in each operation state during a visit,  $E_{i,k_i}$ , and the energy expended during transitions,  $E_{ij}$ , where  $i, j$  in the above description denote the number of operation states available and for this model is constrained by  $1 \leq i, j \leq 4$ .

$$E = \sum_{\forall i,k_i} E_{i,k_i} + \sum_{\forall i \neq j} E_{ij} \\ = \sum_{\forall i,k_i} P_i\tau_{i,k_i} + \sum_{\forall k_4} P_{amp}(d_{k_4})\frac{l_{k_4}}{R_c} + \sum_{\forall i \neq j} P_{ij}m_{ij}\tau_{ij} \quad (4)$$

## 3. CONCLUSION

This paper proposes a complete energy model for WSN that uses the idea of dynamic power management. The operation states are based on the basic sensor node model, and it also takes into account the delay and energy consumption in the transition states so an accurate analysis of both the delay and the energy consumption can be done for a sensor node or network. Since this energy model is more detailed than the energy models presented in [1], it also provides a more accurate description of the energy consumed by a sensor node.

## 4. REFERENCES

- [1] R. A. Mini, M. do Val Machado, A. A. Loureiro, and B. Nath. Prediction-based energy map for wireless sensor networks. *Science Direct Journal in Ad Hoc Networks*, 3(2):235–253, March 2005.
- [2] A. Sinha and A. Chandrakasan. Dynamic power management in wireless sensor networks. *IEEE Design and Test of Computers*, 18(2):62–74, April 2001.

# Poster Abstract: Receiver Oriented Trajectory Based Forwarding

A. Capone, M. Cesana, I. Filippini, L. Fratta and L. Pizziniaco  
Politecnico di Milano, Dip. di Elettronica e Informazione, Italy  
"surname"@elet.polimi.it

## ABSTRACT

Trajectory Based Forwarding (TBF) is a new approach to routing in ad hoc wireless networks. It exploits node position information and, similarly to source routing, requires the source node to encode a trajectory into the packet header. The routing process does not require to specify forwarding nodes. As a matter of fact, forwarding nodes are dynamically selected while packets cross the network according to their position with respect to the trajectory. Therefore, this new approach is particularly suitable for application scenarios where network topology is fast varying, due to node mobility (e.g. inter-vehicular networks) or to energy management schemes (e.g. sensor networks), whereas the stability of the trajectories is guaranteed by the physical characteristics of the service area (roads, building aisles, etc.).

This extended abstract describes a new TBF scheme that shifts forwarding decision from transmitter to receiver exploiting broadcast transmissions.

## 1. INTRODUCTION

Wireless ad hoc networks have attracted the attention of the networking research community in the last years. After an initial phase during which general solutions for ad hoc networking have been proposed, current research activities are focusing on specific application scenarios whose characteristics can be exploited to improve efficiency and reliability. The most promising applications include pervasive networks and vehicular networks.

In both pervasive and vehicular networks cases, routing paths, defined as sequence of forwarding nodes, are unstable due to topology changes. In the first case topology changes are due to energy management schemes while in the second case to terminal mobility. On the other hand, geographical routes, defined as lines, are quite stable due to the physical characteristics of the service area (roads, building aisles, etc.).

*Trajectory Based Forwarding (TBF)* [1] exploits this basic observation proposing a routing scheme that, similarly to source routing, requires the source node to encode a geographical trajectory, into the packet header. Since the sequence of forwarding nodes is not specified, packets are routed hop-by-hop according to nodes positions with respect to the trajectory. There are two fundamental issues of TBF that must be considered: trajectory design and forwarding mechanism. In this paper we focus on the latter.

The forwarding schemes proposed in [1] and in [2, 3] are based on point-to-point transmissions. Each forwarding node, upon packet reception, sends the packet to the neighbor node in the best position with respect to the trajectory. Since the information on neighbor positions is essential for the forwarding algorithm, it must be kept updated together with the information on neighbors' status (active, non-active). The existing forwarding schemes adopt different neighbor selection algorithm and trajectory representations.

In this paper we describe SiFT (Simple Forwarding over Trajectory) [4], a novel TBF scheme that is based on broadcast transmissions and does not require neighbor positions and states, since the forwarding decision is shifted from the transmitter to the receiver [5, 6].

## 2. SIMPLE FORWARDING OVER TRAJECTORY

Differently from previously proposed TBF schemes, SiFT uses broadcast instead of point-to-point transmissions. Wireless transmissions are broadcast in nature and allow to reach all active neighbors at the same time. Each node that receives a packet takes the decision whether forwarding it or not based on its own position, the transmitter position and the trajectory. Such an approach greatly reduces the control overhead and the energy consumption.

### 2.1 Single stream trajectory

Let us first consider the simpler case when the packet has to be forwarded along a single stream trajectory that is defined as an ordered sequence of straight segments. Each node, upon a packet reception, sets a timer according to its position with respect to the trajectory and the transmitter:  $T_{out} = \tau \frac{D_t}{D_l}$ , where  $D_t$  is the distance between the node and closest trajectory segment,  $D_l$  is the distance from the last node that transmitted the packet, and  $\tau$  is a constant representing the time unit. If a node receives another copy of the packet before the timer expires, the timer is stopped and the packet is deleted from the forwarding queue. Otherwise, when the timer expires, the packet is processed by the Medium Access Control (MAC) layer for transmission. As a result of this procedure, the packet is forwarded by the node with the minimum  $T_{out}$ , i.e. the node in the best position: far from the last the node and close to the trajectory.

The information needed by SiFT and carried in the packets header includes: the trajectory, the coordinates of the last node visited, the packet source identifier, the packet

sequence number, and the hops count. To avoid cycles, each node must maintain a list of recently received packets (source ID and sequence number).

SiFT can be implemented over any MAC scheme, but its performance depends on the characteristics of the MAC scheme used. Note that this forwarding approach is quite robust against transmission error and collisions since, for its correct operation, it is sufficient that one of the neighbor nodes receives the packet. Moreover, in the unlucky case that no node successfully receive the packet, the transmitting node can detect the problem and retransmit it.

Similarly to source routing, the overhead to code the trajectory depends on the number of segments. Before forwarding a packet, the node modifies the trajectory information by keeping only the segments not yet travelled.

## 2.2 Forwarding strip

Due to limited transmission ranges, the above procedure may enable more than one node to forward a packet. As shown in Fig. 1 a packet transmitted by  $A$  is first forwarded by  $C$  (the node in the best position). Its transmission prevents node  $B$  and  $D$  to forward the same packet, but not nodes  $E$  and  $F$  that are out of reach from  $C$ .

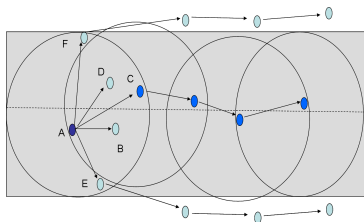

Figure 1: Forwarding strip

This situation may lead to duplicated packets travelling in the network along "parallel" trajectories at a distance from the original trajectory at least equal to the transmission range. The trajectories, however, soon or later will merge again thus limiting the waste of network resources due to duplicated packet transmissions. We observed such a behavior in our simulation experiments in all network topologies.

To further limit packet duplication, a distance threshold (forwarding strip) can be introduced: if the distance from the trajectory is larger than the threshold, e.g. the transmission range, the node refrains from forwarding process.

## 2.3 Tree trajectory

We now consider SiFT scheme operation when the trajectory is represented by a tree of segments. In this case, multiple forwarding is needed when the packet reaches a tree splitting point (tree branching). A copy of the packet must follow each branch to reach all intended destinations. According to the SiFT scheme, a node, upon reception of a packet carrying a tree trajectory information, computes a timer for each branch in its transmission range. Similarly

to the single-stream trajectory case, the node modifies the trajectory information in the packet header including the segments belonging to the corresponding branch. In the example shown in Fig. 2, where segments of the tree trajectory are numbered from 1 to 7, a packet transmitted by  $A$  is received by  $B$  and  $C$ . Both nodes identify the two branches  $\alpha$  and  $\beta$ . Node  $B$  is within transmission range with both branches and then computes timer  $T_\alpha^B$  and  $T_\beta^B$ . The packet to be forwarded when  $T_\alpha^B$  expires will identify in its header segments 2, 4 and 5, while the packet to be forwarded when  $T_\beta^B$  expires will identify segments 3, 6 and 7. Similarly, node  $C$  computes  $T_\beta^C$  and modifies packet header including segments 3, 6 and 7. At  $T_\alpha^B$ ,  $B$  transmits the packet that will follow branch  $\alpha$ . Two copies of the packet to follow branch  $\beta$  are ready for transmission, but only the one with the smaller timer, will be forwarded. This procedure allows packet copies to complete the tree trajectory following all different branches.

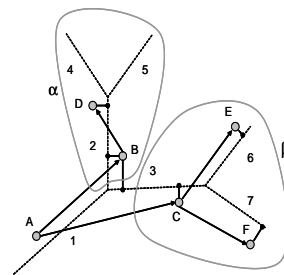

Figure 2: Tree-based Forwarding.

## 2.4 Other issues

We mention here other issues of SiFT we cannot describe into details due to length constraints. We developed an algorithm for overcoming obstacles (physical obstacles or topology holes) along the trajectory. We have also analyzed the performance of SiFT with CSMA-based MAC schemes and evaluated the impact of the interaction among the SiFT timers and the carrier sense information. Finally, we have devised an analytical model of SiFT that allows to get more insights on its behavior.

## 3. REFERENCES

- [1] D. Niculescu, B. Nath, *Trajectory Based and Its Application*, in proc. of ACM Mobicom '03, 2003.
- [2] B.Nath, D. Niculescu. *Routing on a curve* in ACM SIGCOMM Computer Communication Review, vol. 33, no. 1, January 2003.
- [3] M. Yuksel, R. Pradhan, S. Kalyanaraman, *An Implementation Framework for Trajectory-Based Forwarding in Ad-Hoc Networks*, in proc. of IEEE ICC '04, June 2004.
- [4] A. Capone, I. Filippini, M.A. Garcia and L. Pizziniaco. *SiFT: An efficient method for Trajectory Based Forwarding*. 2nd International Symposium on Wireless Communication Systems 2005 (ISWCS '05).
- [5] M. Zorzi, R. R. Rao, *Geographic Random Forwarding (GeRaF) for Ad Hoc and Sensor Networks: Multihop Performance*, IEEE Transactions on Mobile Computing, vol. 2, no. 4, pp 337-348, Oct-Dec 2003.
- [6] O. Goussevskaia, M.D.V. Machado, R.A.F. Mini, A.A.F. Loureiro, G.R. Mateus, J.M. Nogueira, *Data dissemination based on the energy map*, IEEE Communications Magazine, vol. 43, no. 7, July 2005, pp. 134-143.



# Poster Abstract: Architecture of a scalable wireless sensor network for pollution monitoring

Karl Baumgartner

University of Applied Sciences of Western Switzerland  
IICT  
CH-1401 Yverdon  
+41 (0)24 557 64 72

karl.baumgartner@heig-vd.ch

Stephan Robert

University of Applied Sciences of Western Switzerland  
IICT  
CH-1401 Yverdon  
+41 (0)79 567 98 35

stephan.robert@heig-vd.ch

## ABSTRACT

Pollution is nowadays emerging as a major threat for the human being. Cities' sizes are increasing, as well as the number of inhabitants living in urban areas. Therefore, air pollution monitoring becomes an important concern for the scientific and political world. This paper describes a scalable architecture for monitoring air pollution in large areas where collected data will be represented through an Internet interface. The proposed solution is based on the presence of multiple sinks in the Wireless Sensor Network (WSN).

## Keywords

Wireless sensor network, ad-hoc network, Cluster-based routing, Pollution monitoring, collecting data.

## 1. INTRODUCTION

Environmental monitoring has generated a large amount of information for scientists. The purpose of this experience is to improve our knowledge about the impact on nature of human being. Data are collected by sensors, which are usually measuring temperature, humidity or air pressure. However, any sort of gas may be monitored for the need of a specific project. Fifteen years ago, the only suitable way to centralize information coming from sensors was the use of cables. This was an important barrier to the development of sensor networks. Nowadays, Wireless Sensor Networks have permitted new way of research. The nodes are organized on an ad-hoc wireless architecture (no fixed infrastructure is employed). Sensor networks often have a root point called sink where data are collected. The radio coverage of each node is usually not large enough to reach a sink. Hence, the nodes have implemented a protocol called Multi-hop routing to allow them to send information to the sink via other nodes [1]. The large size of our sensor network forces us to employ multiple sinks.

This poster describes and discusses an architecture for implementing a solution to centralize data from the multiple sink. We proposed a solution and practical tools which collects the sensor measurements and dispatches them through a TCP/IP-based network. The node sink is connected to an embedded computer via the RS232 port where the data are temporary stored inside a database. Then, the data saved in every sinks are sent to the centralized database server.

Existing solutions have already been described. In [2], where an argument against data centralization is given, multi-hop routing is not used and the data are only accessible from a specific location. This type of architecture may be set up for military operation or disaster recovery for instance. Furthermore, there is an interesting discussion about Multiple-sink sensor networks in [3] where a logical graph model has been developed to adapt a mono-sink architecture to a multi-sink architecture, which decreases significantly the energy consumption of each node. However, no new protocol has been effectively designed.

## 2. Hardware

The most important element of the project infrastructure is the nodes which should implement the wireless communication to the sensors. We want to use materiel which supports TinyOS and have a low consumption. Tinynode 584 with its extension board (Figure 1) manufactured by Shockfish matches exactly our needs.

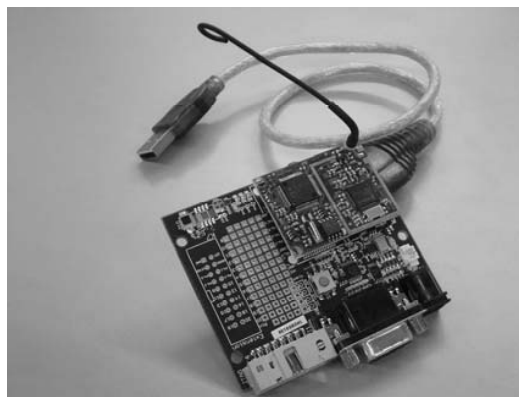

Figure 1: Tinynode and Standard Extension Board

The microcontroller is an MSP430F1611 (Texas Instrument) with 10 kB of RAM, 48 kB of flash and 128 B of memory. The CPU is a low power 16-bit RISC with 16 bit register. Wireless transceiver: Xemic XE1205 with the following key features: RF output power up to 15 dBm (programmable), high sensibility down to -121 dBm at 1.2 kbit/s, bit rate up to 152.3 kbit/s,

continuous phase 2-level modulation, operate in the 433, 868 and 915 MHz (but tinynode 584 only use the 868), low-consumption and many other useful features as RSSI (Received Signal Strength Indicator). Furthermore, this material is optimized to run TinyOS and is based on an ultra low power 3 V design. The interface RS-232 and Jtag (principally used for debugging) are present on the extension board.

### 3. Architecture

The architecture of this sensor network is described in Figure 2. The data coming from the sensor are routed to the sink node via the multi-hop routing protocol. Then, the sink nodes transmit the messages through the RS-232 interface to an embedded computer called sink computer (the sink node and the sink computer are geographically at the same location). Every sink computer is connected to the Internet network, which allows them to transmit the sensor information to a centralized database server. For this purpose, several different ways to do it are possible. It slightly depends on the geographical location of the sink and the physical available communication infrastructure. Four standard technologies have been used: GPRS access, ADSL access, Satellite access or direct connection with Ethernet.

For all these solutions, the TCP/IP stack has to be implemented. Consequently, an embedded PC implementing the TCP/IP stack has to be part of the sink. Also, the data will have to be buffered inside this computer in case of failure or disconnection of the TCP/IP network. For this reason, a database (Mysql) has been used. Finally, the port RS232 will interface between the embedded computer and the node. The programming language which has been used is Java, principally because of its portability. Furthermore a large number of APIs are available, which reduces the development time. Globally, the sinks collect the data coming from the ad-hoc network and store them into local databases. Periodically, data are sent to the centralized database server through the TCP/IP stack. During the whole process the integrity of data is guaranteed.

The database server collects the information coming from the multiple sinks. It is important to note that it is always the designated sinks that will set up the connection to the server. This is because the sinks will probably be hidden behind a Network Address Translation (NAT) server which shares a single IP address to many end users. Then, the General Manager is the tool used to control and manage the totality of the architecture. This application will be a kind of log centre. Every log message generated by the sink application will be automatically sent to it. Another functionality of General Manager is to control the Wireless Sensor Network where many parameters may be changed. And finally, the server database can be accessed easily and user-friendly from anywhere on the Internet.

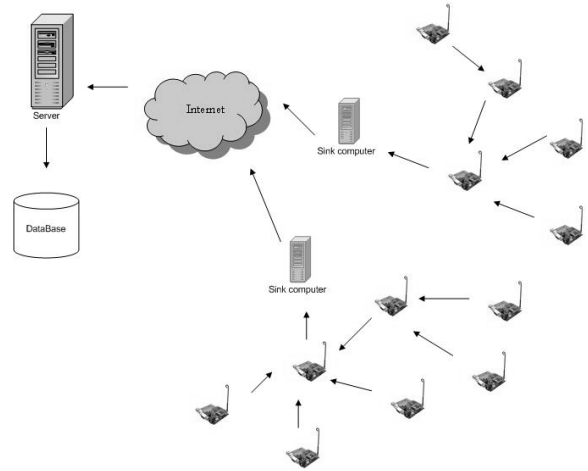

**Figure 2: Architecture of data acquisition of the WSN using multiple sink and a centralized database**

### 4. Conclusion

Our solution copes exactly for the requirement of such large network implementations. Another important innovation of our proposal concerns its adaptability to any sort of high level applications. The main difference with existing solutions is the presence of an embedded computer which shares the work and the intelligence with the centralized database server. The architecture has still to be tested with a real pollution monitoring application. The next step of this project is to integrate pollution sensors ( $\text{NO}_2$  and  $\text{O}_3$ ) with the TinyNodes.

### 5. Acknowledgment

This work was supported by the MICS (Mobile Information & Communication Systems) and the IICT (Institute for information and communication technologies)

### 6. References

- [1] A. Woo, T. Tong, and D. Culler, "Taming the underlying challenges of reliable multihop routing in sensor networks", In Proceedings of the 1st international Conference on Embedded Networked Sensor Systems (Los Angeles, California, USA, November 05 - 07, 2003). SenSys '03. ACM Press, New York, NY, 14-27.
- [2] C. Curino, M. Giani, M. Giorgetta, A. Giusti, A.L. Murphy, and G.P. Picco, "TinyLime: Bridging Mobile and Sensor Networks through Middleware", In Proceedings of the 3rd IEEE International Conference on Pervasive Computing and Communications (PerCom), Kauai Island, Hawaii, USA, March, IEEE Computer Society, pp. 61-72, 2005
- [3] A. Das and D. Dutta, "Data acquisition in multiple-sink sensor networks", SIGMOBILE Mob. Comput. Commun. Rev. 9, 3 (Jul. 2005), 82-85.

# Poster Abstract: Energy Efficient Area Coverage in Arbitrary Sensor Networks

Markos Sigalas

Information and Communication Systems Engineering  
Department, University of the Aegean

Karlovassi, Samos 83200

Greece

cs00043@icsd.aegean.gr

George Vouros

Information and Communication Systems Engineering  
Department, University of the Aegean

Karlovassi, Samos 83200

Greece

georgev@aegean.gr

## ABSTRACT

Arbitrary sensor networks comprise randomly deployed sensors that may have different capabilities and capacities and are fully autonomous. This paper deals with static nodes in synchronized networks that have different sensing and communication capabilities and different energy capacities. The paper describes our first results towards a fully localized solution for energy efficient area coverage of arbitrary sensor networks that comprise autonomous nodes. According to the proposed solution a node sleeps when (a) it is not needed for preserving system's connectivity and (b) its sensing area is covered. This solution works very efficiently for nodes with different sensing and communication abilities, relaxing many of the limitations and assumptions made in other proposals.

## Keywords

Sensor networks, area coverage, energy efficiency.

## 1. INTRODUCTION

Aiming at deploying fully autonomous sensor nodes in hostile and inaccessible terrains so as to report data to a single server station, we deal with arbitrary sensor networks' self-organization capabilities. Arbitrary sensor networks have a random topology and comprise fully autonomous sensors with differing capabilities and capacities. In this paper we deal with static nodes in synchronized networks that have different sensing and communication capabilities. Therefore, each sensor has communication (CR) and sensing (SR) radii that may differ among themselves (i.e.  $CR_i \neq SR_i$  for the node  $I$ ) as well as between different sensors (i.e. given two nodes  $I$  and  $J$ , in the general case it holds that  $CR_i \neq CR_j$ ,  $SR_i \neq SR_j$ ,  $SR_i \neq CR_j$  and  $CR_i \neq SR_j$ ). Furthermore, the energy capacity of each sensor may differ from the capacity of other nodes in the network.

The aim of this paper is to provide the results of a fully localized solution towards prolonging the lifetime of arbitrary sensor networks whose objective is to monitor a geographic area and report data to a single station. The paper contributes towards relaxing limitations, assumptions and constraints that hold in other approaches as far as the topology and nodes' abilities are concerned, ensuring full area coverage, system's connectivity and node's autonomy. Approaches that aim to provide a fully localized solution in energy efficient area coverage [2], either do not ensure full area coverage, they compute a large percentage of active nodes [3], or the nodes that cover an area are not ensured to

be connected [1]. A very recent approach [4] aims at reducing communication overhead and preserve connectivity, but assumes that all the nodes have the same communication and the same sensing radii at any time point— which is not realistic in cases where nodes' capabilities are affected by the energy they consume.

This paper examines an enhancement of the method proposed by Tian and Georganas (TG) [1]. The proposed method allows dealing with arbitrary networks where node's communication abilities affect systems' connectivity and node's sensing abilities affect area coverage. To test the proposed solution we simulated arbitrary networks comprising of Medusa MK2 - like nodes [5] that have to report to a single sink server. For simulation reasons we assume that initially all sensors have the same sensing and communication abilities: This changes at later time points as sensors consume energy independently from each other. Generally, at any specific time point during systems' lifetime, the sensing and communication radii of different nodes are different.

## 2. PROBLEM STATEMENT

Let  $G$  be an arbitrary network of neighboring sensors  $S$ .  $G$  has a random topology characterized by its density  $d$ . Each sensor  $I$  in  $S$  is static and has communication and sensing abilities. Specifically, at every time point  $t$  during network's lifetime a sensor is specified by  $\langle I, PR^I_t, CR^I_t, SR^I_t, ST^I_t, BL^I_t, CM^I_t \rangle$ .  $I$  is the identification number of each sensor and is unique for every node.  $PR^I_t$  is the priority of each node, which is specified to be a function of node's remaining battery.  $CR^I_t$  is the communication range of each node and  $SR^I_t$  is its sensing range.  $ST^I_t$  is the state of the node and can be either "active" or "sleeping".  $BL^I_t$  is the remaining battery level of the node at time  $t$  in mA. Finally,  $CM^I_t$  is a consumption matrix that specifies the consumption rate of each sensor component in active and in static states. Figure 1 shows a dialog box of our simulation software where one may specify  $CM$ . The default figures (except for the sensor component) are those of the Medusa MK2 node. It must be noticed that all the characteristics of a node, except  $I$  and  $CM^I_t$ , change during systems' life time as a function of  $BL^I_t$ .

The neighboring sensors  $N(I)$  of a sensor  $I$  at time  $t$  are those whose distance from  $I$  is less than  $CR^I_t$ .  $N(I)$  may change between different time points due to the changing  $CR^I_t$ .

Let  $G$  be an arbitrary network of sensors whose task is to report monitoring data from an area to a single sink station BS. Let also  $L(G)$  be the lifetime of  $G$  in seconds. The problem addressed in this paper is to maximize  $L(G)$  subject to preserving the

connectivity of the network at every time point  $t$ ,  $0 \leq t \leq L(G)$ . In other words, given  $t$  with  $0 \leq t < L(G)$ , and given that  $C_I[t, t+1]$  is the consumption of the node  $I$  in the interval  $[t, t+1]$ , our aim is to minimize  $K[t, t+1] = \sum_I C_I[t, t+1]$ . Since at any unit interval

$[t, t+1]$  the set of nodes  $S$  can be partitioned to the set of active nodes  $A$ , and to the set of sleeping nodes  $S$ ,  $K[t, t+1] = \sum_{I \in A} C_I[t, t+1] + \sum_{I \in S} C_I[t, t+1]$ .

Consumption per Component		
	Active (mA)	Kidle (mA)
ATMegal128L :	5.5	1.0
Sensor :	2.9	0.0
RFM :	2.9	5.0
THUMB :	25.0	10.0

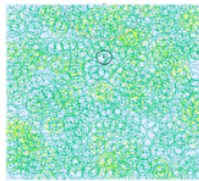

Figure 1. Consumption per component and a 1000 nodes system deployment in an 500x500 area ( $d=5$ ).

Given the consumption specifications in Figure 1, any node  $I$  with  $ST_I^t = \text{“active”}$  consumes approximately 2.3 times more energy than if  $ST_I^t = \text{“sleeping”}$ , given that the node sends a single message while being in any state. Therefore, the goal is to keep as many nodes as possible in the “sleeping” state and exchange the minimum number of messages between nodes during  $[t, t+1]$ . Nodes exchange messages so as (a) to be informed about the state of their neighboring nodes and decide about their own state, and (b) to send data to the sink server via a multi-hop route.

### 3. APPROACH and RESULTS

According to our approach, each node  $I$  that is determined to be non-active at a time point  $t$  –using the area coverage method proposed by Tian and Georganas (TG)– examines its covering neighbors to determine whether they are connected. It then waits for a time interval which is inversely proportional to its priority  $PR_I^t$  and examines the connectivity of its active neighbors. Its active neighbors contain its covering (monitoring) neighbors and any of its highest priority neighbors that have determined to be active (gateways).

Using this method nodes need to know only their one-hop neighbors: They exchange a “hello” message to learn their neighbors’ sensing and communication radii and they may send/receive the state of their highest priority neighbors at any time  $t$ . Simulation results shown in Figure 2 are very encouraging, showing the potential of the method for arbitrary networks. Figure 2(d) shows the lifetime of networks in which  $SR_I = CR_I$  versus their density (the pattern is the same for the other types of networks): The increase rate is low given that even sleeping nodes consume energy at a high rate.

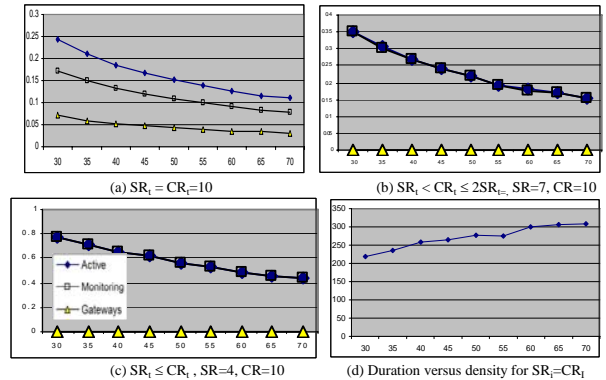

Figure 2. Percentage of active nodes versus network density.

### 4. CONCLUSIONS

We have shown the potential of a method for prolonging the lifetime of an arbitrary sensor network subject to keeping it connected so as nodes to report to a single server. Future work concerns the enhancement of the method towards asynchronous networks and the study for further reduction of the number of messages by using enhancements of the TG method [6]. Furthermore, although redundancy is desirable for the reliability of the network, we need to compute and control the redundant nodes added.

### 5. REFERENCES

- [1] Di Tian and N. D. Georganas, “A Coverage-Preserving Node Scheduling Scheme for Large Wireless Sensor Networks”, *Proc. First ACM Intl. Workshop on Wireless Sensor Networks and Applications*, pages 32-41, Sept. 2002.
- [2] J. Carle and D. Simplot-Ryl, “Energy-Efficient Area Monitoring for Sensor Networks”, *IEEE Computer Magazine*, Vol. 37, February 2004, pages 40-46.
- [3] J. Carle, A.Gallais and D. Simplot-Ryl, Area coverage in wireless sensor networks based on surface coverage relay dominating sets. *Proc. 10<sup>th</sup> IEEE Symposium on Computers and Communications (ISCC 2005)*, Cartagena, Spain, June, 2005.
- [4] A.Gallais, J. Carle, Simplot-Ryl, and I.Stojmenovic. Localized Sensor Aerea Coverage with Low Communication Overhead, In *Proc. 5th Scandinavian Workshop on Wireless Ad-hoc Networks (ADHOC’05)*, Stockholm, Sweden, 2005.
- [5] Andreas Savvides and Mani B. Srivastava, “A Distributed Computation Platform for Wireless Embedded Sensing” – *Proceedings of the 2002 IEEE International Conference on Computer Design: VLSI in Computers and Processors (ICCD’02)*, page 202, 2002.
- [6] J. Jiang and W. Dou. A coverage preserving density control algorithm for wireless sensor networks. In *ADHOC-NOW*, Vancouver, LNCS 3158, pg 42-45, July 2004.

# Poster Abstract: Toward Adaptive Wireless Sensor Networks

Silvia Santini

Institute for Pervasive Computing, ETH Zurich  
8092 Zurich, Switzerland  
santinis@inf.ethz.ch

## 1. INTRODUCTION

Being deployed close to the real world, wireless sensor networks allow to monitor the evolution in time and space of a variety of real world phenomena. The sensor nodes, covering a given region of interest, can perform at typically regular time intervals a distributed sampling of some measurable physical quantity. At each time instant, the information residing in the network can thus be visualized as a snapshot of this physical phenomenon. Reporting these snapshots to an interested user requires the sensor nodes to relay their sensor readings to a sink node and thus imply a significant communication overhead. Since radio communication is known to be the dominant factor of energy consumption in wireless sensor networks [7], efficient data gathering strategies are needed to conserve the typical poor network resources. One common approach to reduce the amount of data that need to be delivered to the user is to select, among all data produced by the sensor network, a subset of sensor readings such that the original observation data can be reconstructed within some user-defined accuracy. Exploiting spatio-temporal correlation among data, for example, it is possible to identify a subset of sensor readings from which the remaining measurements can be predicted within a given minimal accuracy. Readings which can be predicted from already delivered data do not need to be reported to the sink, thus reducing communication. Prediction can be performed in both time and space for example on the basis of some pre-defined model, as proposed in a series of recent papers [2, 3, 5]. While model-based prediction techniques have proven to be effective for reducing communication in wireless sensor networks, they not only suffer from performance losses when the model becomes outdated, but are also not well-suited to follow fine grained changes in sensor readings. To overcome these drawbacks we refer to the classic adaptive filter theory and propose an alternative solution for performing predictions over data streams which do not require any a-priori knowledge about the phenomena of interest [4]. Adaptive filters are typically used in environments where signals with unknown and non-stationary statistics are involved and appear for this reason particularly suited to be used in highly dynamic systems like sensor networks.

We present a prediction-based strategy for performing efficient data gathering in sensor networks that exploits the Least-Mean-Square (LMS) adaptive algorithm. The LMS is an adaptive algorithm with very low computational overhead and memory footprint that – despite its simplicity – provides excellent performance. We show that our strategy can significantly reduce the number of readings that a sen-

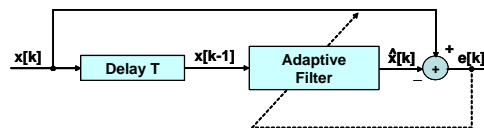

Figure 1: Adaptive predictor.

sor node is required to report to a sink node, while ensuring that the user can reconstruct the original observation data within a pre-specified minimal accuracy  $\epsilon_{max}$ .

The work presented in this paper constitutes a preliminary step toward the realization of a fully adaptive wireless sensor network, which we envision to be able to autonomously adapt to environmental and network dynamics and correspondingly allocate network resources. The LMS-based prediction scheme can indeed be hierarchically extended to perform a *joint* prediction over a block of readings from neighboring nodes. Since a joint prediction can capture spatial correlation among neighboring sensors, a further reduction in communication can be achieved.

In the next section we briefly explain our adaptive, quality-based strategy for data reduction in wireless sensor networks, while in Section 3 we report our experimental results and point out some open issues and directions for further research.

## 2. OUR APPROACH

Figure 1 shows the general structure of an adaptive filter used as a predictor. The basic principle consists in computing an estimation  $\hat{x}[k]$  of the current input value  $x[k]$  as a weighted sum of the previous  $N$  samples:

$$\hat{x}[k] = \sum_{i=1}^N w_i[k] * x[k - i] \quad (1)$$

where  $w_i, i \in \{1, 2, \dots, N\}$  are the so-called *filter weights*. The actual prediction error is thus easily computed as  $e[k] = \hat{x}[k] - x[k]$  and fed back to the adaptation algorithm, which accordingly updates the filter weights. In order to minimize the average error power  $E\{e^2[k]\}$ , the LMS algorithm modifies at each time step the filter weights according to the following update equation:

$$\underline{w}[k+1] = \underline{w}[k] + \mu \underline{x}[k]e[k] \quad (2)$$

where the *step-size*  $\mu$  is a parameter that controls the convergence speed of the algorithm and can be easily estimated from the input signal power [4, 6]. In equation 2 above,  $\underline{w}[k]$  and  $\underline{x}[k]$  represent the vectors:  $[w_1[k], w_2[k], \dots, w_N[k]]^T$  and  $[x[k-1], x[k-2], \dots, x[k-N]]^T$ . From equations 1 and 2 it can be seen that, provided the number of filter weights  $N$  to be sufficiently small, the LMS algorithm has a very low computational load, since it only needs  $2N$  operations for computing the prediction and  $2N+1$  operations for the weights updating.

In our scheme, the LMS algorithm runs on both a sensor and a sink node. As long as the prediction error exceeds a user-defined threshold  $e_{max}$ , the node works in *normal* mode, i.e., it keeps computing the prediction at each time step, transmitting its readings to the sink node and feeding back the prediction error to the weight adaption algorithm. As long as the node remains in *normal* mode, the sink lets the prediction filter run over the received sensor readings in order to update the filter weights coherently with the node<sup>1</sup>. If, while working in *normal* mode, the sensor node observes the prediction error remaining below the threshold  $e_{max}$  for  $N$  consecutive readings, it switches to *stand-alone* mode, i.e., it just discards the reading and inputs the predicted value  $\hat{x}[k]$  to the filter instead of the actual value  $x[k]$ . The sink, receiving no data from the node, implicitly assumes the predicted readings being a good enough approximation of the real readings and keeps thus running the prediction filter on these values, as well as the node does. If at a given time step the prediction error, continuously monitored by the sensor node, exceeds the threshold  $e_{max}$ , the node switches again to *normal* mode. We will show in the next section, that implementing this simple dual prediction scheme with the adaptive LMS algorithm we are able to achieve significant communication reduction.

### 3. EVALUATION AND OPEN ISSUES

In this section we present the results obtained when applying our LMS dual prediction scheme to real world data, as well as some open issues which are object of our current research.

We tested our LMS-based data reduction strategy on a set of real world data publicly available at [1]. Once every 31 seconds, humidity, temperature, light and voltage values were collected from 54 Mica2Dot sensor nodes deployed in the Intel Berkeley Research Lab between February 28 and April 5, 2004. To report our results, we picked 4 of these 54 motes, namely motes 1, 11, 13, and 49 which were distributed in different sectors of the deployment area. We applied our scheme to the data reported by the temperature sensors of these four motes between March 6 and 9.

In Figure 2 we report the percentage of sensor readings that

<sup>1</sup>Since wireless transmission in sensor networks is known to be unreliable, it is likely to happen that some of the node's reported readings never reach the sink node, thus causing a misalignment between the prediction filter at the node and the correspondent filter at the sink. For simplicity, we assume for the remainder of this section a loss-free communication link between the nodes and the sink. See section 3 for a discussion of a mechanism that allow to relax this assumption.

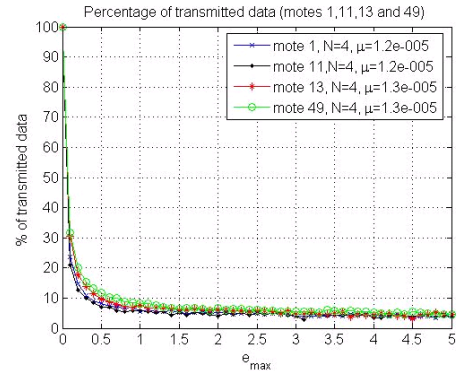

**Figure 2: Percentage of transmitted data by motes 1, 11, 13, and 49, for a filter length  $N = 4$ .**

the four selected motes need to report as the error budget  $e_{max}$  increases, for a filter length  $N = 4$ . As it can be seen, a minimal accuracy of  $0.5^\circ\text{C}$  can be guaranteed while transmitting only about 10% of the collected sensor readings. This significant data reduction is due to the optimal tracking capability of the LMS algorithm. We would like to point out that in our experiments no significant changes in the performances are observed when varying the number of filter weights from  $N = 4$  to  $N = 10$ . Moreover, using these small values of  $N$  allow to keep extremely low the computational overhead and memory footprint of the algorithm.

In order to relax the assumption of loss-free communication, we are currently investigating an alternative approach, where, based on the actual packet loss ratio  $p$  of the link between source and sink (known using either an a priori estimate or in situ measurements), a modified *equivalent* error budget  $e_{max}^e = f(p, e_{max}) \leq e_{max}$  is computed and used instead of  $e_{max}$ , such that, on average, accuracy  $e_{max}$  can be achieved even in case of message loss. This solution will of course cause some deterioration with respect to the performances presented above, but will also allow to apply and test our approach in a more realistic framework.

Moreover, we are currently working on an extension of our prediction scheme to perform prediction jointly in both the time and space domain.

### 4. REFERENCES

- [1] Intel lab data: <http://db.lcs.mit.edu/labdata/labdata.html>.
- [2] A. Deshpande, J. H. C. Guestrin, S.R. Madden, and W. Hong. Model-driven data acquisition in sensor networks. In *VLDB'04*, Toronto, Canada, 2004.
- [3] S. Goel and T. Imielinski. Prediction-based monitoring in sensor networks: Taking lessons from mpeg. *ACM Computer Communication Review*, 31(5), 2001.
- [4] S. Haykin. *Least-Mean-Square Adaptive Filters*. Wiley-Interscience, New York, 2003.
- [5] A. Jain, E. Chang, and Y.-F. Wang. Adaptive stream resource management using kalman filters. In *ACM SIGMOD/PODS Conference (SIGMOD '04)*, Paris, France, June 2004.
- [6] G. Moschytz and M. Hofbauer. *Adaptive Filter*. Springer Verlag, Berlin, 2000.
- [7] J. Polastre, R. Szewczyk, and D. Culler. Telos: Enabling ultra-low power research. In *IPSN/SPOTS'05*, Los Angeles, USA, April 2005.

# Poster Abstract: Interfacing the Real World with Ubiquitous Gateways

Christian Frank, Christof Roduner  
ETH Zurich, Department of Computer Science  
Clausiusstrasse 59  
8092 Zurich, Switzerland  
{chfrank, roduner}@inf.ethz.ch

Chie Noda, Marco Sgroi, Wolfgang Kellerer  
DoCoMo Communications Laboratories Europe  
Landsberger Str. 312  
80687 Munich, Germany  
{noda, sgroi, kellerer}@docomolab-euro.com

## ABSTRACT

We describe the opportunities and challenges of using mobile phones as ubiquitous service gateways that mediate between emerging sensor technologies and networks of smart items on the one hand and existing global networks and service infrastructure on the other hand. We present an application for such a system to support users when they search for daily-life objects that they have lost or misplaced. Along with a description of the scenarios, we outline a system architecture including tagged objects, object detectors and mobile phones, and show future research directions.

## 1. INTRODUCTION

In our everyday life we often search for personal items such as keys, wallets, umbrellas or sports bags that we have either lost or misplaced. Emerging technologies, such as RFID systems and wireless sensor networks, properly integrated by traditional mobile infrastructure, have a great potential to allow finding these objects quickly and effectively when needed. We envision that daily-life objects will be equipped with small electronic tags that will allow detecting them via radio communication. This will allow mobile phones to *sense* objects (or act as gateways to devices with object sensing capability) and thus both record and distribute useful context information related to users and their belongings.

In this paper we present a system implementing what we call the “Remember & Find” application. The system architecture includes *tagged objects* (TOs) and *object sensors* (OSs), which are devices that can sense and identify TOs and can be integrated within mobile phones. Moreover, OSs are interconnected with the backend infrastructure through mobile phones, thus allowing remote access to objects and detection of their location. We term a mobile phone, which acts as a mediator between the OSs and the wide area network infrastructure, *ubiquitous gateway* (UG). The wide-area infrastructure can support a wide range of end-user services. For example, a UG equipped with an OS can keep track of the user's personal objects and monitor when, where and under which circumstances an object has left the UG's communication range [1]. This data can later help the user locate the object. In some cases, a user may use his UG to delegate the monitoring of personal objects. For example, smart baggage shelves can be tasked to remind a train traveller not to leave an object behind or to notify the user if the object has been taken by somebody else [2].

We consider the following use case scenarios of the “Remember & Find” application:

- **Remember Loss Context:** A UG can be used to store the context in which an object left its communication range. This includes (among others) the following data: a trace of the user's location before and after the loss event, other people present, or other personal objects carried along when the object was lost. Such information can provide the user with valuable hints regarding the location of a lost object. On the one hand, the data may help humans recall the circumstances of the loss. On the other hand, the data can be used to guide an automated object search (see next use case).
- **Find Object:** The user can send a query to many remote UGs or OSs to locate a misplaced or lost object. Queries are installed at remote gateways, e.g., colleagues' mobile phones. The user will be notified when the object is found in range.
- **Delegation of Control:** The user can delegate the tracking of an object from the personal UG to other UGs or OSs [2].
- **Lab Gate:** An OS can be installed in proximity of a student lab to record which objects leave the lab with whom. This allows intuitive and non-intrusive check in / check out processes for the equipment used in the lab.

The “Remember & Find” application is an instance of a recently emerging class of applications using heterogeneous wireless sensor networks interconnected by a wide-area infrastructure. Such applications require integrating two areas of research, namely infrastructure-supported distributed systems and energy-efficient infrastructure-less sensor networks.

Interestingly, bringing together these two areas to form a *Sensor Internet* exhibits particular new challenges. For example, in the above “Find Object” use case, scalability demands distributing a query only to a subset of all UGs or OSs present in the system. This a-priori *query scoping*, i.e., the selection of a relevant subset of sensors without ever contacting the rest, will be based on history data present in the system – data on objects, users, and their present or previous locations.

## 2. SYSTEM ARCHITECTURE

The above use cases require retrieving a variety of context information from sensors. The abstraction of sensor information on the UG is called a *basic event source*. When a predefined condition is detected, a *notification* is generated that contains the historical values recorded by a variety of event sources. The query service of the UG is used to specify which conditions

should be detected and what notifications should be generated. A notification can be sent to a remote user's UG or to an appropriate (global or personal) database in the backend infrastructure.

Figure 1 shows an overview of the system architecture. The backend infrastructure hosts the *global query manager*, which provides event routing and large-scale query distribution. The query distribution is based on *scope providers* which implement different heuristics for query scoping based on history data. For example, a scope provider could be based on personal or global databases containing information on past object locations and implement a heuristic that starts searching where the object was last seen. A different scope provider could employ the *location profile* (based on [3]), which is able to extract the user's most frequented locations and thus direct queries to sensors at these locations. A third example of a scope provider could be based on the *association registry*, which relates users to their objects and to other UGs in the system. Such a scope provider could direct queries for a user's object to associated UGs and to UGs of associated users, assuming that these are likely to find the object.

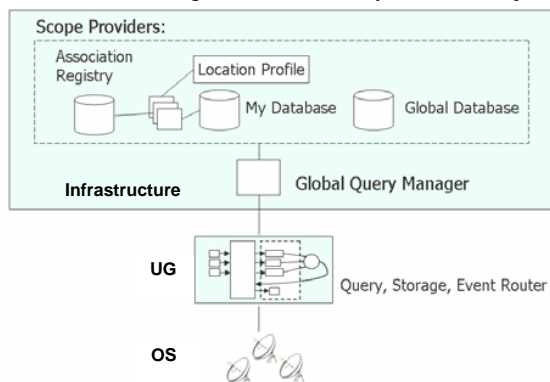

Figure 1. System Architecture

Note that scope providers need not necessarily be executed in the backend infrastructure. Rather, the middleware allows developers to configure where system components are executed. Privacy-sensitive components for example, such as the location profile or a personal association registry, can also be executed on the user UG.

### 3. QUERY SERVICES

We have implemented query processing services that allow for the setup of both the backend infrastructure and of the UGs involved in the above-described use cases. There are two types of queries: the UG query that specifies how an individual UG shall use its integrated OSs when processing the query (e.g., if an object should be sensed using RFID, Bluetooth, or both) and a query directed to the global query manager that specifies to which UGs a query shall be distributed, and where the resulting events shall be delivered to.

#### 3.1 UG Query Service

As mentioned, basic event sources are components that provide a unified interface to a given kind of context data available on the UGs. Application developers can parameterize these components to generate events regarding a certain type of context information. For example the *location* source would

generate an event whenever the user's location has changed (based on GPS or the current cell id). Other basic event sources used for object monitoring perform repeated polling for all tagged objects with a given frequency, while generated events include a list of discovered objects. In contrast to *public* objects that can be detected by any OS, *secure* objects can be polled only using an access key for access control and privacy protection. Here the corresponding event source component performs polling for one particular object and encapsulates the object owner's access key. An event is generated when the object is out of range for a continuous timeout interval.

The application developer may employ these basic event sources to compose a UG query: In particular, for each query *one* event source is used as a trigger for generating a notification (any event-detection functionality can be pragmatically encapsulated into a custom-implemented basic event source). The *contents* of the generated notification can include the values of any number of basic event sources, not only at the time the notification is triggered (e.g., by an event source that fires an event whenever an object is out of range) but also previous and / or future observations (e.g., of the user location). Thus the query service must store a history of values of a basic event source for a specified sliding history window. The UG query processor enables efficient memory management when multiple queries that require the same event source with different parameters are installed on a UG. Once a trigger condition is satisfied, the notification includes clips of certain data retrieved from the history windows maintained at the UG.

### 3.2 Global Query Service

In order to facilitate the deployment of applications in a large-scale infrastructure, our framework supports a global query manager. It enables transparent distribution of queries to multiple UGs. The global query manager relays queries to the most appropriate UGs, keeps track of active queries, and removes them upon expiration or when the searched object is found. Further, it isolates the party initiating a query from the party receiving it and vice versa. This allows effective enforcement of privacy and accounting policies. Moreover, it provides methods to monitor and control the costs incurred by querying. At the *global* query interface, the application developer may thus specify which type of *UG query* to distribute, which *scope providers* to use and a number of additional parameters, such as the maximum costs of the search.

### 4. FUTURE WORK

As part of current work, we are developing a search algorithm that may incorporate and integrate *any* kind of history data for query scoping, and building a prototype implementation of the middleware services we have outlined above.

### 5. REFERENCES

- [1] G. Borriello, W. Brunette, M. Hall, C. Hartung, and D. Tangney: Reminding about tagged objects using passive RFIDs. In *UbiComp 2004*, Nottingham, England, Sep. 2004
- [2] H. Simizu et al.: Association management between everyday objects and personal devices for passengers in urban areas. Demo abstract in *Pervasive 2005*, Munich, Germany, May 2005
- [3] K. Laasonen, M. Raento, H. Toivonen: Adaptive on-device location recognition. In *Pervasive 2004*, Vienna, Austria, Apr. 2004





## Demonstration Abstracts

# Demo Abstract: Concealed Data Aggregation and Topology Aware Group Keying for WSNs

Joao Girao and Dirk Westhoff  
 NEC Europe Ltd.  
 {joao.girao,dirk.westhoff}  
 @netlab.nec.de

## ABSTRACT

End-to-end encryption for wireless sensor networks is a challenging problem. To save the overall energy resources of the network it is agreed that sensed data need to be consolidated and aggregated on their way to the final destination. For such circumstances we present an approach that (1) conceals sensed data end-to-end, by (2) still providing efficient in-network data aggregation. The aggregating intermediate nodes are not required to operate on the sensed plaintext data. We apply a particular class of encryption transformation and discuss, using examples, the approach on the basis of two aggregation functions.

This demonstrator consists of a prototype implementation of these functions in the actual sensors, together with visualization tools that make the solution visible.

## 1. INTRODUCTION

Most scenarios in Wireless Sensor Networks (WSN)s presume computation of an optimum, e.g., the minimum or maximum, the computation of the average, or the detection of a movement pattern. Computation of these operations may either be fulfilled at a central point or by the network itself. The latter is beneficial in order to reduce the amount of data to be transmitted over the wireless connection. Since the energy consumption increases linearly with the amount of transmitted data, an aggregation approach helps to increase the WSN's overall lifetime. Another way to save energy is to only maintain a connected backbone for forwarding traffic, whereas nodes that perform no forwarding task persist in idle mode until they are re-activated.

CDA aims at performing in-network aggregation over encrypted data, rather than encrypting and decrypting at each aggregation point. To this purpose, we apply a special class of encryption transformations denominated as Privacy Homomorphisms (PH)s. This particular class of encryption transforms allows operations on ciphertext (addition and/or multiplication) such that:

$$\begin{aligned} \text{Additively homomorphic:} & \quad \mathbf{a} + \mathbf{b} = \mathbf{D}_k(\mathbf{E}_k(\mathbf{a}) + \mathbf{E}_k(\mathbf{b})) \\ \text{Multiplicative homomorphic:} & \quad \mathbf{a} * \mathbf{b} = \mathbf{D}_k(\mathbf{E}_k(\mathbf{a}) * \mathbf{E}_k(\mathbf{b})) \end{aligned}$$

We are particularly interested in the addition operations since we can decompose aggregation functions such as “average” and “movement detection” into in-network addition operations as shown in [2].

We have implemented a reference PH, Domingo-Ferrer [5], as part of this prototype and a key pre-distribution mechanism such as described in [4], both suitable for CDA. The routing is also dynamically determined by an implementation of a “going-down” routing protocol, which represents the reverse multicast traffic class for which CDA is applicable.

Once a sensor node receives a broadcasted service request message from the sink, it perform the encryption operations on the values read from the environment and sends this encrypted data to the aggregators. The aggregators then perform the aggregation function based on the encrypted values and send the result to the sink. The sink performs the decryption and semantical analysis of the result.

As part of the key pre-distribution mechanism, sensors that belong to different regions, in the demo represented by the different aggregators, have a high probability that the keys used for this symmetric scheme are different. Aggregators and simple forwarders do not store any sensitive information. The following two images illustrate simulation work done on the subject.

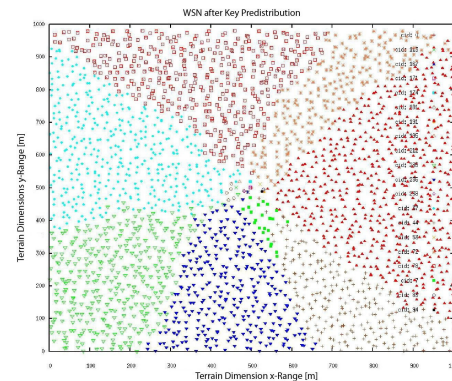

Illustration 1: Simulation results on the cluster distribution

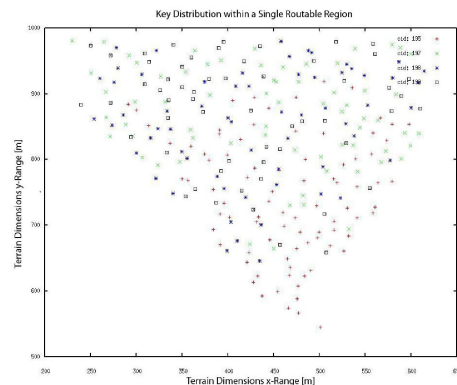

Illustration 2: Simulation results on the key distribution inside a cluster

## 2.DEMO SETUP

The demo is composed of two laptops and seven sensors. Two of the sensors act as interface to the WSN and are used by the laptops.

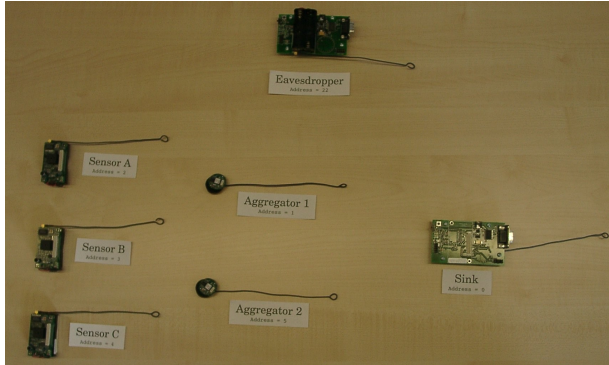

Illustration 3: Demonstration Setup

In the current set-up, three sensors are sensing data and sending to two distinct aggregators. The aggregators then perform the aggregation function and send the result to the sink.

A sensor connected to a laptop called the eavesdropper is placed outside the network to observe the traffic and collect information on the data packets transmitted. Both the laptops provide visual information on the network.

Time	Src	Dest	type	href	cid	count	wait	Values
0.0	0	65535	CDA_SINK	0	755	0	4096	0 0
0.29	1	65535	CDA_SINK	1	4	0	2048	0 0
1.39	5	65535	CDA_SINK	1	8	0	2048	0 0
1.59	3	65535	CDA_SINK	2	4	0	1024	0 0
1.58	2	65535	CDA_SINK	2	4	0	1024	0 0
1.695	4	65535	CDA_SINK	2	8	0	1024	0 0
2.979	3	1	CDA_SENS	2	4	1	0	74086688 61588848
3.17	2	1	CDA_SENS	2	4	1	0	64149546 12724167
3.199	4	5	CDA_SENS	2	8	1	0	21430884 133369331
3.199	5	0	CDA_AGGR	1	8	1	0	21430884 133369331
13.317	0	65535	CDA_SINK	0	255	0	1024	0 0
13.357	5	65535	CDA_SINK	1	8	0	512	0 0
13.399	1	65535	CDA_SINK	1	4	0	512	0 0
14.330	4	65535	CDA_SINK	2	8	0	0	77214127 244012978
14.467	3	1	CDA_SENS	2	4	1	0	13934666 12025338
14.716	2	1	CDA_SENS	2	4	1	0	2113104516 41249881
14.359	5	0	CDA_AGGR	1	8	1	0	77214127 244012978
14.489	4	0	CDA_AGGR	1	4	2	0	243680656 160803121
16.939	0	65535	CDA_SINK	0	755	1	1024	0 0
16.989	1	65535	CDA_SINK	1	4	1	512	0 0
17.39	5	65535	CDA_SINK	1	8	1	512	0 0
17.59	2	1	CDA_SENS	2	1	1	0	17789725 216142866
17.98	3	1	CDA_SENS	2	4	1	0	84745971 259284635
17.156	4	5	CDA_SINK	2	8	1	0	86689963 180517493
17.989	1	0	CDA_AGGR	1	4	2	0	76184326 445647021
18.48	5	0	CDA_AGGR	1	8	1	0	86689963 180517493

Illustration 4: Graphical User Interface at the Eavesdropper

The laptops and programming boards (two) require power. The demo does not require Internet connection nor specific wireless channel reservation since they run on different radio frequencies from those of 802.11a and b/g.

Time	Src	Type	Encrypted values	Count	Value	Position
0.0	1	ENCRYPTED_VALUES	318236154 18883015	2	-	-
0.49	5	ENCRYPTED_VALUES	21430884 133369331	1	-	-
1.897	-	FINAL_RESULT	77214127 244012978	3	2	n/a
18.493	1	ENCRYPTED_VALUES	343036056 195803121	2	-	-
11.315	-	FINAL_RESULT	-	3	2	n/a
16.55	1	ENCRYPTED_VALUES	26184326 445647021	2	-	-
14.301	5	ENCRYPTED_VALUES	86689963 180517493	1	-	-
16.978	-	FINAL_RESULT	-	3	3	0:1:1

Illustration 5: Graphical User Interface at the Sink

## 3.ACKNOWLEDGMENTS

This work is in part supported by the EU Framework Programme 6 for Research and Development Daidalos project (IST-2202-506997). ([www.ist-daidalos.org](http://www.ist-daidalos.org))

## 4.REFERENCES

- [1] J. Girao, D. Westhoff and M. Schneider. Concealed Data Aggregation in Wireless Sensor Networks. ACM WiSe04 - poster in conjunction with ACM MobiCom 2004, Oct. 2004.
- [2] J. Girao, D. Westhoff and M. Schneider. CDA: Concealed Data Aggregation for Reverse Multicast Traffic in Wireless Sensor Networks. 40<sup>th</sup> International Conference on Communications (IEEE ICC 2005), May 2005.
- [3] M. Acharya, J. Girao and D. Westhoff. Secure Comparison of Encrypted Data in Wireless Sensor Networks. WiOpt 2005, Apr. 2005.
- [4] D. Westhoff, M. Acharya and J. Girao. Concealed Data Aggregation for Reverse Multicast Traffic in Wireless Sensor Networks: Encryption, Key Distribution and Routing. To appear in IEEE Transactions on Mobile Computing, Jan. - Mar. 06.

# Demo Abstract: Low-Power Multihop Sensor Networking using WiseMAC

Amre El-Hoiydi and Jean-Dominique Decotignie

Swiss Center for Electronics and Microtechnology (CSEM), Neuchâtel, Switzerland

## 1. INTRODUCTION

Most applications of wireless sensor networks require both a low sensor node cost and a lifetime of multiple years. These two application requirements translate in the ultra low-power system requirement. Reaching an ultra low-power consumption requires both to use a low-power hardware and to power-on this hardware only a small fraction of the time. The WiseNET project running at CSEM resulted in the design of both a low-power sensor node system-on-chip hardware (WiseNET SoC) and a low-power communication protocol stack (WiseNET Stack). A crucial component of the WiseNET stack is the WiseMAC protocol. WiseMAC[1] is a low-power medium access control protocol that has been designed specifically for low-power multi-hop sensor networks. It uses the preamble sampling technique to mitigate idle listening. A high energy efficiency is achieved in medium to high traffic conditions through the minimization of the wake-up preamble length. This demonstration illustrates the low-power consumption of the WiseMAC protocol using a hardware platform made with off-the-shelf chips<sup>1</sup>.

## 2. HARDWARE PLATFORM

The low-power multi-hop communication demonstration is made using WiseNodes version 1 developed at CSEM (see Fig. 1). This platform is based on off-the-shelf components. It includes a XE1203F radio operating at 868 MHz and a XE88LC06A micro-controller, both from Semtech (previously Xemics), an EEPROM, an AD converter and a temperature sensor as well as an extension bus. At 3 volts, the power consumption of the XE1203F radio amounts to 42 mW in receive mode (-109 dBm sensitivity @  $10^{-3}$  BER and 25 kbps) and 129 mW in transmit mode (10 dBm tx power).

We are now migrating to the next version of the WiseNodes that will be based on the WiseNET SoC[2]. The radio of the WiseNET SoC consumes only 2.1 mW in receive mode (-108 dBm sensitivity @  $10^{-3}$  BER, 25 kbps FSK, 868 MHz) and 35 mW in transmit mode (8.5 dBm tx power). The WiseNET SoC operates between 1 V and 1.6 V to minimize energy consumption and to enable the use of low-cost alkaline batteries as the energy source. The SoC is in finalization stage. First samples have been successfully tested.

The size of the available data memory is respectively 512

<sup>1</sup>The work presented in this abstract was supported in part by the National Competence Center in Research on Mobile Information and Communication Systems (NCCR-MICS), a center supported by the Swiss National Science Foundation under grant number 5005-67322.

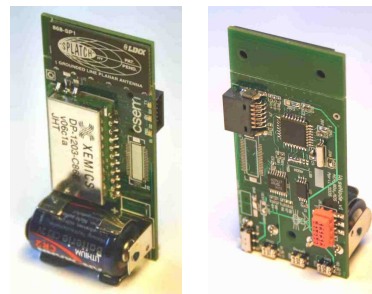

Figure 1: WiseNode\_v1.

and 1024 bytes for XE88LC06A and the WiseNET SoC. Both versions offer 25 kbytes program memory.

## 3. PROTOCOL STACK

The WiseNET protocol stack is illustrated in Fig. 2. The communication protocols are composed of the WiseMAC and the routing layers. The application can be embedded into the WiseNode micro-controller and/or implemented in a second micro-controller dedicated to the application. The communication between an optional host controller and a WiseNode module is handled through the host controller interface (HCI). The HCI interface can also be used to connect any node to a gateway via a serial interface (RS-232 or SPI). This interface permits a central computer to send network management commands piggy-backed onto routing floods. The network management commands include application level transmission requests as well as remote parameter configuration at radio, MAC and routing level. To permit source code portability among platforms, a hardware

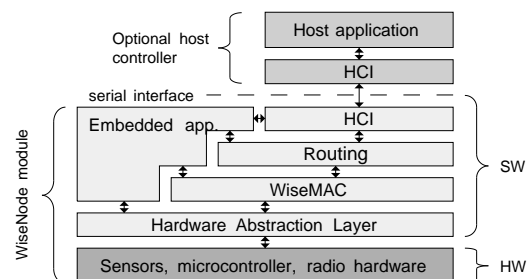
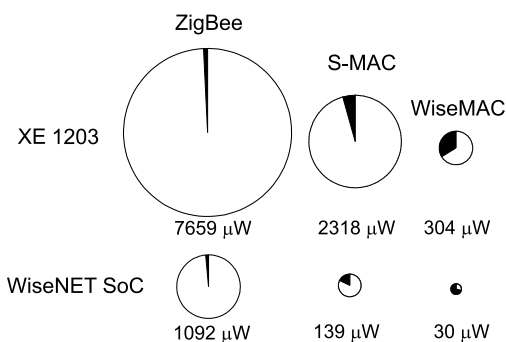

Figure 2: WiseNET Protocol Stack.



**Figure 3: Power consumption when forwarding a 32 bytes packet every 30 s in a multi-hop network (wake-up period = 250 ms).**

abstraction layer has been defined. In its current state, the WiseNET protocol stack uses about 20 kbytes, leaving 5 kbytes for the application. From these 20 kbytes, the MAC layer accounts for 5 kbytes and the routing layer for 1.5 kbytes. The rest is needed for drivers and low-level gcc libraries.

## 4. PERFORMANCE

### 4.1 Theoretical results

Fig. 2 shows the theoretical average power consumption when forwarding a packet of 32 bytes every 30 seconds in a multi-hop sensor network. Packet losses due to collisions or noise are not considered. The power consumption has been computed for WiseMAC, S-MAC and IEEE 802.15.4 ZigBee using the parameters of the off-the-shelf XE1203F radio (platform WiseNode\_v1) and the parameters of the WiseNET SoC (platform WiseNode\_v2). S-MAC is assumed to be operated at 10% duty cycle, its default setting. Let us call wake-up period the sampling period in WiseMAC, the beacon interval in IEEE 802.15.4 and the listening period (or frame duration) in S-MAC. With all protocols, the hop delay is equal to the wake-up period at worse and to half the wake-up period at best. A wake-up period of 250 ms has been selected for all protocols.

The white area represents the basic overhead of each protocol. The black area is the cost of forwarding packets. It can be observed that WiseMAC provides a significant reduction in the power consumption when compared to IEEE 802.15.4 ZigBee and to S-MAC with both hardwares. With the indicated traffic and wake-up period, WiseMAC consumes about 7 times less than S-MAC and 25 times less than ZigBee. The use of the low-power WiseNET SoC hardware reduces further the power consumption by a factor of 10.

It can be observed that IEEE 802.15.4 ZigBee suffers from a large overhead. This is caused by the need of transmitting every 250 ms (with the chosen wake-up period) a beacon of 19 bytes and of listening during 55 bytes for potential traffic from children after the beacon, as well as the need of periodically listening to the beacon of one's parent.

### 4.2 Experimental results and demo

The test network consists of 14 WiseNodes\_v1 arranged in a tree-network. Node number 1 is connected via RS-232

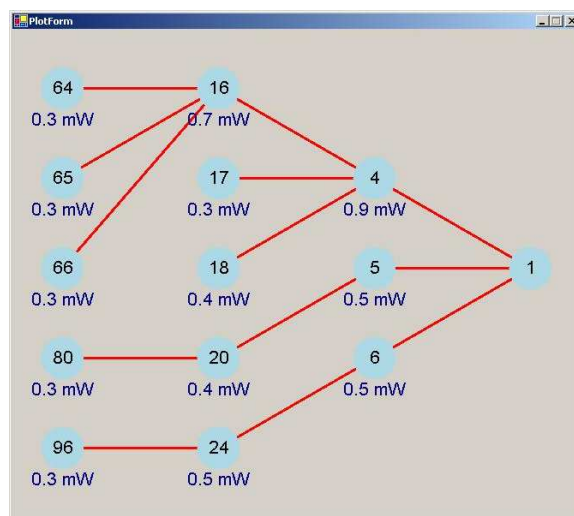

**Figure 4: Measured power consumption of the WiseNodes when every nodes sends a 32 bytes packet every minute.**

to a computer that controls the network and collects data.

Fig. 4 shows the average power consumption of WiseNodes when every node sends a 32 bytes packet to the sink every minute. An ARQ scheme in the WiseMAC protocol guarantees the transmission of every packet to the sink. The wake-up period is  $T_W = 250$  ms, providing an average hop delay of about this value. Power consumption is computed through the measurement by every node of the time spent with the radio in the receive and in the transmit states. No data aggregation is made. Nodes closer to the sink carry a higher traffic. It can be observed that the power consumption of the leaf nodes is about 0.3 mW. This translates into a lifetime of about 12 months with the 3V 850 mAh Lithium battery used on the WiseNodes. The node number 4 consume 0.9 mW. Its lifetime is about 3 months.

## 5. CONCLUSION

Multi-hop sensor networking experiments done with off-the-shelf chips have confirmed the low-power capability of the WiseMAC protocol. An average power consumption below 1 mW can be achieved for a relatively high traffic in a multi-hop topology. Using the same protocol stack with the WiseNET SoC low-power hardware, an average power consumption below 100  $\mu\text{W}$  can be obtained.

## 6. REFERENCES

- [1] Amre El-Hoiydi and Jean-Dominique Decotignie. WiseMAC: An Ultra Low Power MAC Protocol for Multi-hop Wireless Sensor Networks. In *Proc. First International Workshop on Algorithmic Aspects of Wireless Sensor Networks (ALGOSENSORS 2004)*, *Lecture Notes in Computer Science, LNCS 3121*, pages 18–31. Springer-Verlag, July 2004.
- [2] V. Peiris *et al.* A 1V 433/868MHz 25kb/s-FSK 2kb/s-OOK RF Transceiver SoC in Standard Digital 0.18 $\mu\text{m}$  CMOS. In *Int. Solid-State Circ. Conf. Dig. of Tech. Papers*, Feb. 2005, pp. 258-259.

# Poster abstract: Building Adaptable Sensor Networks with Sensor Cubes

H. Dially,<sup>1</sup> K. Raja,<sup>1</sup> I. Daskalopoulos,<sup>1</sup> S. Hailes,<sup>1</sup> T. Torfs,<sup>2</sup> C. Van Hoof<sup>2</sup> and G. Roussos<sup>3</sup>

<sup>1</sup>University College London, UK

<sup>2</sup>IMEC, Integrated Systems Department, Belgium

<sup>3</sup>Birkbeck College, University of London, UK

{d.dially,k.raja,i.daskalopoulos,s.hailes}@cs.ucl.ac.uk, {torfst,vanhoofc}@imec.be, g.roussos@bbk.ac.uk

## ABSTRACT

In this poster and demonstration we present the Sensor Cube platform, an ultra-compact, modular and power-efficient way to build sensor networks. The design, implementation and the complete technical details of this platform have been discussed elsewhere. Here, we aim to showcase the platform in action and argue in support of its features. Sensor Cubes are developed using two ingredients: a stackable hardware design recently developed by the human++ research initiative at IMEC, and a Tiny OS based operating environment. The hardware measures less than a cubic centimetre when configured with standard environmental monitoring capability and integrated coplanar antenna. The operating and software development environment is derived from Tiny OS, which has been modified to meet the hardware requirements of the Sensor Cube. In particular, we have introduced a power-aware, reliable, ALOHA-type MAC protocol that closely matches the operational characteristics of the low-power radio chip. In this poster and demonstration we will show the Sensor Cubes executing standard data harvesting tasks.

## 1. INTRODUCTION

Over the past two years a variety of wireless sensor node platforms have emerged each offering particular benefits in building sensor networks. In this poster we introduce the Sensor Cube platform, which we believe distinguishes itself by providing novel opportunities for the construction of modular, ultra-compact and energy-efficient sensor networks. Indeed, Sensor Cubes offer increased flexibility in systems design and implementation compared against previous sensor network platforms. In this poster and demonstration, we present Sensor Cubes in action and aim to showcase their unique features.

The technical details of Sensor Cubes have been detailed in a series of papers [1, 4, 7] and here we concentrate on their effective and efficient operation in a practical situation. It is noteworthy that the platform hardware has been developed within the ongoing human++ research initiative at IMEC, Belgium, which is primarily focused on the development of body sensor networks. The addition of a fully functional runtime based on Tiny OS [2] and associated development tools offer the opportunity for the general-purpose use of this platform in additional application areas. The demonstration is based on the use of the popular Tiny OS Surge application.

## 2. HARDWARE PLATFORM

Sensor Cubes are built on the hardware platform recently developed at IMEC [1, 7] which offers two distinct advantages over the current state-of-the-art: first, it provides for an ultra-

compact design including an integrated coplanar antenna that allows for very low power consumption; and second, it supports pluggable modules that allow for the physical reconfiguration of nodes to include only the functionality required for a particular application.



**Figure 1. The Sensor Cube hardware platform developed by IMEC: Layers from top: Radio, Microcontroller, Power and Sensor Module. A 2€coin provides a size reference.**

The currently available hardware modules of the Sensor Cube platform include the micro-controller, radio communication, power and sensor. The prototype implementation, which will be used in the demonstration, features these functional blocks implemented as printed circuit boards of size 14x14mm<sup>2</sup>, plugged together to form a four-layer stack (Figure 1). This connector-based implementation is 18mm in height but an alternative design is also available, whereby solder-ball interconnections are used instead thus reducing the stack height to only 10mm (Figure 2).

At the top of the stack sits the radio layer consisting of the Nordic nRF2401 2.4GHz wireless transceiver chip [3] and an integrated antenna. The second (micro-controller) layer incorporates the Texas Instruments MSP430 micro-controller [6], with digital input/output, 12-bit analogue-to-digital converter, universal synchronous-asynchronous receiver/transmitter, and clock system and timers.

Below the micro-controller are the power management and sensing layers: the power management layer is designed so that in addition to batteries it can receive power from an energy-harvesting device (including, but not limited to, solar cells and vibration scavengers). The available sensing equipment used for this poster and demonstration is a Sensirion SHT15 board incorporating a temperature/humidity sensor and a Light-Dependent Resistor [5].

Of particular relevance to this work are the power-efficient operational characteristics of the radio module, including its transmit and receive power consumption, its built-in power-saving modes and its relatively high bit-rates for data transfer

(250kbps transmit and 1Mbps receive). In particular, the radio module supports the following modes of operation: transmit mode (13mA average at 0dBm output power); receive mode (23mA average for both channels on); configuration mode (12uA average); stand-by mode (12uA average); and power down mode (400nA average).

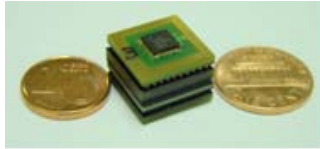

**Figure 2. The Sensor Cube alternative hardware implementation using solder ball interconnect technology.**

The overall modular design of Sensor Cubes allows for considerably increased adaptability when supporting a variety of application scenarios:

- When a large geographic area must be covered with a low-density sensor network it may be necessary to replace the radio layer to optimise overall performance.
- In cases where high data rates and complex signal processing functions are required, a more powerful digital signal processor could be employed in an alternative microcontroller layer.
- In cases where particular specialized sensors and associated sensor electronics are required (for example chemical, electrical or biosensors) they could be accommodated within this design on a separate module.
- In cases where power beyond that provided by the battery is necessary, or when a full power management system with scavenging is needed, such components could and have been developed and added as separate modules.

### 3. SOFTWARE PLATFORM

While assembling a fully functioning software platform has been a critical milestone for the system, actual operational experience indicated early on that it was necessary to re-engineer the standard Tiny OS network protocol stack to achieve appropriate levels of performance. The process of porting Tiny OS to the Sensor Cubes has been detailed elsewhere [4] and here we only briefly present the operation of the energy-efficient MAC protocol, which was introduced to match the operational characteristics of the Nordic chip.

The use of Nordic radio chip in particular imposes a number of limitations, notably due to lack of a high speed clock source – necessary to substantially reduce power consumption – which prevents the use of its so-called Direct mode and thus restricts the ability to control its radio efficiently. Furthermore, the maximum frame size in the alternative Shockburst mode is limited to 32 bytes, which must accommodate both the control header and the payload. Using a combination of the two modes available is not an option, as the radio configuration word cannot be modified during operation. Nevertheless, in Shockburst mode the radio component can concurrently operate two separate channels, a capability we exploited to decouple data transmission from the transmission and receipt of acknowledgements.

The implemented MAC design employs the payload section of the ShockBurst frame to encapsulate Tiny OS Active Message packets constructed by the OS. This leaves only 20 bytes per

packet for application payload but this should be enough for the majority of applications. In case where packets require additional space it is their responsibility to manage fragmentation.

The use of the Shockburst mode as the principal mode of communications implies that two addresses are encapsulated in every data packet: the Shockburst broadcast address and a node-specific address within the AM header. This approach allows us to combine the performance advantages of Shockburst while at the same time retaining the capability to address data to specific nodes, thus maintaining unicast semantics.

A second feature of the MAC protocol is the fact that the receiver employs a set duty cycle that switches the radio between stand-by and receive mode at regular intervals so as to reduce energy consumption. The percentage of time the radio stays in each mode can and should be controlled by the application and defined at development time. A detailed discussion of the implications of various choices of duty cycle in the context of a specific empirical study is detailed in [4].

Finally, the last design decision has been against employing a carrier sense-based approach but rather to use a simple Aloha-based protocol instead. This decision was made on the basis that collisions are rare in the case of the application scenarios considered, either as a result of low node density or low transmission rates. Given that our principal concern has been to optimise for energy-efficiency, the higher energy cost required by the carrier sense approach is prohibitively high given the frequency of situations for which it would actually be useful. Nevertheless, it is still necessary to address the problem of collisions whenever they arise and also to deal with the cases in which the receiver is in stand-by when required to receive and hence unable to do so. To address both of these issues, link level acknowledgements and retransmissions are used whereby the transmitter waits for an acknowledgement for a fixed (but configurable by the application) period. If no acknowledgement is received then the packet is retransmitted. Note that since the transmitter cannot distinguish packets that are lost due to collision, and those lost because the receiver was in stand-by mode, it resends its packets until it receives an acknowledgement or reaches the Maximum Retransmission count (which is also configurable by applications).

### 4. REFERENCES

- [1] K. Baert, B. Gyselinckx, T. Torfs, V. Leonov, F. Yazicioglu, S. Brebels, S. Donnay, J. Vanfleteren, C. Van Hoof, "Technologies for highly miniaturized autonomous sensor networks", *1<sup>st</sup> Int. Wor. Adv. Sensors and Interfaces (IWASI)*, Bari, Italy, April, 2005.
- [2] P. Levis, S. Madden, D. Gay, J. Polastre, R. Szewczyk, A. Woo, E. Brewer and D. Culler, "The Emergence of Networking Abstractions and Techniques in TinyOS," *Proc. NSDI 2004*, San Francisco, California, USA, 29-31 March, 2004.
- [3] Nordic Semiconductor, "nRF2401A Single Chip 2.4 GHz Radio Transceiver".
- [4] K. Raja, I. Daskalopoulos, H. Dially, S. Hailes, T. Torfs, C. Van Hoof and G. Roussos, "Sensor Cubes: A Modular, Ultra-Compact, Power-Aware Platform for Sensor Networks", *IPSN SPOTS 2006*, submitted for publication.
- [5] Sensirion, "SHT1x/SHT7x Humidity & Temperature Sensor".
- [6] Texas Instruments, "MSP430x1xx Family User's Guide"
- [7] T. Torfs, C. Van Hoof, S. Sanders, C. Winters, and S. Brebels, "Wireless network of autonomous environmental sensors", *IEEE Sensors Conference*, Vienna, Austria, April, 2004.



# Demo Abstract: Energy Management in Buildings with Sensor Networks

David Garcés  
Particle Computer GmbH  
Haid-und-Neu Str. 7  
D-76131 Karlsruhe  
+49 721 7817353

garces@particle-computer.de

Albert Krohn  
Telecooperation Office (TecO)  
Vincenz-Priessnitz-Str. 1  
D-76131 Karlsruhe  
+49 721 690229

krohn@teco.edu

Odilo Schoch  
Swiss Federal Institute of Technology  
Chair of CAAD, HIL E15.1  
CH-8093 Zurich  
+41 1 6334025

schoch@hbt.arch.ethz.ch

## ABSTRACT

Energy has become one of the main cost drivers in our society. Therefore technical systems and solutions that save energy and keep the costs down gain in importance. In buildings, equipment like air-condition and heating consume high amounts of energy. Even small adjustments can therefore lead to significant lowering of costs. With the help of sensor networks, the monitoring and controlling of facilities can be simplified and improved. In this demo, we present a fine granular and long-term operating system for monitoring the relevant physical parameters of a building both indoors and outdoors.

## Keywords

$\mu$ Part Particle, energy & facility management, sensor facade.

## 1. INTRODUCTION

Our built environment is one of our society's largest investments, e.g. all buildings in Switzerland are worth 2400 billions CHF [1]. Each year, 40 billion CHF are invested in Switzerland in maintenance or in new buildings. The total number of buildings affected exceeds the figure of 2 million. All buildings must provide comfortable space for humans. In order to achieve this goal, an enormous energy flow is needed, resulting in large costs. Saving energy during building operation has therefore both ecological and economical impact.

## 2. STATE OF THE ART

To optimize the parameters for the HVAC (heat, ventilation & air conditioning) equipment, engineers need precise measurements of sunlight irradiation, temperature and air quality. Normally, during the first operating year of a newly constructed building, these measurements are monthly taken to form the basis for the standard adjustment of these energy demanding equipments of the building. This manual process has two main disadvantages:

- It is very cost intensive due to labor costs and its associated transportation costs. The fully burdened (van, tools, fuel, parts, labor, hardware and software) cost of field engineers accounts for \$1,000 per visit [2].
- Taking a single sample per month doesn't provide enough information to fully optimize the HVAC systems.

## 3. MOTIVATION

Wireless sensor networks have the potential to play a significant role in the facility management business. Deploying sensor nodes with the appropriate sensor equipment in each room enables continuous remote monitoring of temperature, sunlight irradiation and air quality. Due to the wireless nature of these networks deployment is not complicated since no cabling must be accomplished. Sensor networks solve the two problems facility management companies face today.

## 4. DEMO DESCRIPTION

The system architecture is depicted in Figure 1. For the demo-system,  $\mu$ Part sensors nodes are deployed inside and outside the building to gather periodic measurements. Over wireless links these values are forwarded to the bridges and routers to collect the data for the back-end application supporting the energy engineers to optimize the setup of the building.

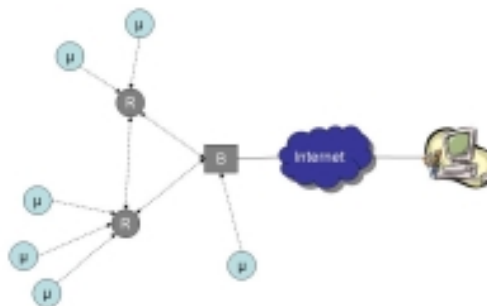

Figure 1. System Architecture with  $\mu$ Part end nodes ( $\mu$ ), router nodes (R) and bridge nodes (B) .

### 4.1 HW Platform

The  $\mu$ Part system is a sensor network built on a minimum hardware and software basis. The small and cost-efficient design enables large-scale settings with high sensor density, but without the need of a high monetary investment. The  $\mu$ Part sensor node comprises a micro controller and ISM-band radio interface and can include light, tilt, temperature, motion and acceleration

sensors. With a CR1632 coin-cell battery the life-time can easily exceed one year with a still high measurement period of several minutes. The overall outline is very small (down to 10x10x5mm including coin cell) and therefore ideally supports the embedding in walls, doors or similar parts of a building.



**Figure 2. µPart sensor node.**

The routers implement the communication for data transport and self-organizing overlay functionalities. They act like a traditional sensor network with outsourced sensors. The µParts as well as the routers encode data as strictly typed tuples using the ConCom [3] data description language. This guarantees a consistent view in all parts of the system.

#### **4.2 SW Back-End**

The software tool being presented during the demonstration will show the variation of temperature and brightness in both time and space axis in the building.

#### **4.3 Installation during EWSN 2006**

A µPart sensor network with a graphical visualization software tool will be installed at the building hosting the EWSN 2006

conference already in January 2006 to gather data over a long period of time.

The whole range of spatial typologies will prove the climatic diversity of a building: ETZ building offers small and large volumetric spaces with each sun illuminated and permanently shaded areas, doors, gathering spaces, etc.

### **5. CONCLUSIONS**

This demonstration illustrates a novel way to optimise the climatic settings of a building.

The conventional method of optimising building climate equipment is expensive and inefficient, since the optimization measures are based on punctual and manual samplings. Using sensor networks to continuously monitor local temperature and sunlight irradiation enables a more efficient use of energy and HVAC machinery. On top of that, sensor networks enable remote access to sensor data, which reduces the costs of the data gathering process.

With large scale sensor networks, the density of data both in space and time can be dramatically improved. This includes monitoring building's behaviour at night, during special events and exceptional climatic events. Data can be then analyzed for future trends in building control, e.g. a building dynamically reacts to weather forecasts and special events.

### **6. REFERENCES**

- [1] [www.up.ethz.ch/research/energy\\_climate/constructed\\_switzerland/](http://www.up.ethz.ch/research/energy_climate/constructed_switzerland/)
- [2] Gartner Technology Research Note T-23-0973
- [3] A. Krohn, M. Beigl, C. Decker, P. Robinson, T. Zimmer, ConCom – A language and Protocol for Communication of Context, Technical Report ISSN 1432-7864 2004/19.

# Demo Abstract: NemoTrack: A RF-Based Robot Tracking System in Wireless Sensor Networks

Xingfa Shen, Hongbin Li, Jun Zhao, Jiming Chen, Zhi Wang<sup>1</sup>, Youxian Sun  
National Laboratory of Industrial Control Technology, Zhejiang Univ., 310027, P.R.China  
xfshen, hbli, zhaojun, jmchen, wangzhi, yxsun @iipc.zju.edu.cn

## Keywords

Tracking, Wireless Sensor Network, Localization, RSSI, Routing, Kalman Filter

## 1. INTRODUCTION

State of the art moving-target tracking systems in wireless sensor networks require either advanced hardware (for example, Cricket [1], Line in the Sand [2]) or sophisticated initial setup stage (for example, MoteTrack [3]). Our effort is to develop a purely motes-based tracking system which can be easily deployed by application developers for large scale sensor networks.

We present a demonstration of the first edition NemoTrack, a RF-based robot tracking system in wireless sensor networks. This tracking system is based on 22 Berkeley Motes (mica2) and a robot made by NLECT, ZJU. For simplicity, NemoTrack system assumes the target to be tracked is cooperative, i.e. a mote sending out RF signals periodically is placed on the robot.

## 2. SYSTEM ARCHITECTURE

The NemoTrack system has mainly five modules: dynamic tracking group management module, signature database module, RSSI-based Weighted-CENTROID localization module, reliable communication module and result refining and visualization module. First four modules are implemented on motes running TinyOS using NesC language, while the last module is implemented on PC running Windows using VS.NET.

### 2.1 Dynamic Tracking Group Management

The functions of *dynamic tracking group management* module [4] are ad-hoc RSSI-based tracking group formation and maintenance including leader election, member recruiting, leader handover and member bailout. Once a tracking group is built, each group member reports its RSSI (Radio Signal Strength Indicator) reading of the RF signal to the group leader if it receives a target signal.

### 2.2 Signature Database

A *signature database* module is running in the leader node recording all the signature entries reported by the members. The database module must handle tasks such as new entries adding, outdated entries deleting, entries sorting by RSSI and database querying efficiently within memory-constrained sensor nodes.

### 2.3 RSSI-based Weighted-CENTROID Localization

Based on this signature database, a *RSSI-based Weighted-CENTROID localization* module [5] is implemented to estimate current position of target. The range-free Weighted-CENTROID algorithm is simple but effective, which is suitable for running on motes platform. In our demo, coordinates of each node can be obtained from its ID. In current implementation, only the top 4 strongest entries by RSSI in the database are chosen as the inputs of Weighted-CENTROID algorithm. We will adopt an adaptive approach to decide how many signature entries will be chosen to take part in localization in future work.

### 2.4 Reliable Communication

In order to refine and visualize the data on the PC, a *reliable communication* module must be implemented to transfer the localization results from current group leader to the designated sink node. This communication module consists of two parts: one is minimum-cost tree-based routing protocol in which each node keeps two parents (a primary parent and a backup parent) by routing cost, and the other is implicit-acknowledgement based retransmission scheme in which the destination node of the retransmission is its backup parent in case of the packet transmitted to primary parent is lost. In current version of NemoTrack system, this communication module hasn't been integrated yet. Instead, the group leader communicates with the sink node directly.

---

<sup>1</sup> corresponding author

## 2.5 Result Refining and Visualization

Based on the localization results from current group leader, the *result refining and visualization* module is implemented on PC. We implement a discrete Kalman Filter to minimize the mean of the squared error of the localization estimation and get a smoother moving trajectory of the robot. Additionally, a C#-based GUI is developed using VS.NET for result visualization. Since the working states of all nodes in the tracking group are piggybacked on the result packet from group leader, we can visualize the changes of group states across the network dynamically for analyzing and debugging.

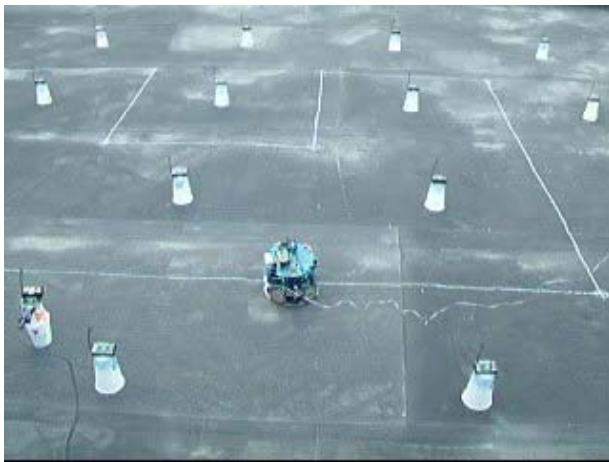

Fig. 1 The demo platform: 5×4 mika2 and a robot

## 3. DEMO DESCRIPTION

As shown in Fig. 1, our demo consists of 20 mika2 motes placed on a 5×4 grid with 1 meter space between each two neighboring motes, with a mote acting as sink node and another as a moving target carried by the robot. In our demo, the robot is moving along a designated trajectory while the tracking trajectory by NemoTrack is shown on the GUI, which is shown in Fig. 2. Different colors of nodes stand for different working states: red stands for group leader, orange means the member taking part in localization, yellow means the member not taking part in localization and gray means the idle node. The orange trajectory is the output of Kalman Filter. The gray dots along the trajectory are the raw localization results of the RSSI-based Weighted-CENTROID localization module from current group leader.

Videos of the demo are available at:  
<http://www.sensornet.cn/project/nemotrack/>



Fig. 2 A screenshot of NemoTrack GUI

## 4. ACKNOWLEDGMENTS

The authors thank the financial support of Key Project of National Natural Science Foundation of China (No. 6043-4030) and Crossbow Wireless Sensor Network Research Excellence Scholarship.

## 5. REFERENCES

- [1] N. B. Priyantha, A. Chakraborty, and H. Balakrishnan, *The Cricket Location-Support system*, Proc. 6th ACM MOBICOM, Boston, MA, August 2000.
- [2] A. Arora, P. Dutta, S. Bapat, V. Kulathumani, H. Zhang, V. Naik, V. Mittal, H. Cao, M. Gouda, Y. Choi, T. Herman, S. Kulami, U. Arumugam, M. Nesterenko, A. Vora, and M. Miyashita, *Line in the Sand: A Wireless Sensor Network for Target Detection, Classification, and Tracking*. In Special Issue of Elsevier Computer Networks on Future
- [3] K. Lorincz and M. Welsh, *MoteTrack: A Robust, Decentralized Approach to RF-Based Location Tracking*, Konrad Lorincz and Matt Welsh. In Proceedings of the International Workshop on Location and Context-Awareness (LoCA 2005) at Pervasive 2005, May 2005.
- [4] R. Nagpal, H. Shrobe, and J. Bachrach, *Organizing a Global Coordinate System from Local Information on an Ad Hoc Sensor Network*, 2nd International Workshop on Information Processing in Sensor Networks (IPSN 03), April 2003
- [5] X. Shen, Z. Wang, and Y. Sun, *Connectivity and RSSI Based Localization Scheme for Wireless Sensor Networks*, Proc. ICIC2005, Lecture Notes in Computer Science. 2005.08

# Demo Abstract: Sensor Network Maintenance Toolkit

Jan Beutel, Matthias Dyer, Kevin Martin  
Swiss Federal Institute of Technology (ETH) Zurich  
8092 Zurich, Switzerland  
beutel,dyer,kevmarti@tik.ee.ethz.ch

## ABSTRACT

The test and deployment and especially the validation of real-world sensor networks embedded into a physical environment are complex tasks that require appropriate tools. The sensor network maintenance toolkit introduced in this contribution enables long-term supervision and maintenance of target sensor networks in their actual application setting using a deployment-support network. The toolkit is composed of different services for remote programming, event detection, logging, analysis and reporting.

## 1. INTRODUCTION

The long-term supervision and maintenance of sensor networks is a complex problem that requires access to all nodes in a target deployment as well as to equip the nodes themselves with the required functionality. In realistic application scenarios, both these requirements are hard to realize. Often nodes are to be deployed in a remote location, resources are limited and nodes operate on an extremely low duty-cycle to minimize cost, power-consumption and as a result maximize the longevity of the application. The deployment-support network [1] has been proposed as a novel tool for the development, test, deployment, and validation of wireless sensor networks. This approach uses a self-organizing backbone network with deployment-support services and so allows direct access to already deployed target nodes in their native environment in a minimal invasive way. The sensor network maintenance toolkit introduces sophisticated services for both maintenance and long-term supervision and monitoring of sensor network applications deployed under real-life conditions.

## 2. DEPLOYMENT-SUPPORT NETWORKS

Classic approaches to develop and deploy wireless sensor networks use serial or ethernet cables for program download, control and monitoring [3]. Although successful in lab setups, this approach is limited due to scalability issues and completely infeasible for deployment in the field. Distributing firmware updates within a sensor network [2] requires nodes to be equipped with buffering and self-reprogramming support and often exhibit an excessive burden on the network itself, with heavy traffic compared to the average network operation and long latencies due to low power duty-cycling.

The deployment-support network (DSN) (see Figure 1) is a new methodology for the development, test, deployment, and validation of wireless sensor networks. A DSN is a ro-

bust, wireless cable replacement offering reliable and transparent connections to arbitrary sensor network target devices. DSN nodes are battery powered nodes that are temporarily attached to some or all target nodes in a sensor network deployment under test. A target adapter on the DSN node is responsible for target control, (re-) programming and logging while a small monitor running on the target sensor node is responsible to output events and status information to the DSN node where it is logged and timestamped. Examples of such logged context are packet arrivals, sensor values as references for calibration, interrupts on the target node or error codes for debugging. Compared to traditional serial-cable approaches, this approach results in enhanced scalability and flexibility with respect to node location, density, and mobility. This makes the coordinated deployment and monitoring of sensor networks possible.

The current reference implementation of a deployment-support network is called JAWS and runs on 30 BTnode rev3 devices in a permanent installation at ETH Zurich.

## 3. SENSOR NETWORK MAINTENANCE TOOLKIT

In order to employ deployment-support network for the development and deployment of a sensor network application, the sensor network maintenance toolkit has been devised as a set of sophisticated services that can be easily adapted and customized according to the maintenance and monitoring requirements.

### 3.1 Remote Programming

The remote programming service allows to disseminate version controlled firmware images along the DSN backbone automatically and reprogram targets on demand. Different types of target architectures are supported by adapting the target adapter on the JAWS application to the target CPU.

### 3.2 Generic DSN Access

The DSN interface specification allows generic access using standardized commands and message formats to the resources of a deployment-support network using either a serial port or the Bluetooth radio on the DSN nodes (BTnode rev3 devices). This can then be used to log the communication flow to a file or display and control the status of the experiment on a graphical user interface. Here, both a setup with a JAWS server and GUI Java applet as well as a Java standalone GUI on a Bluetooth equipped PDA

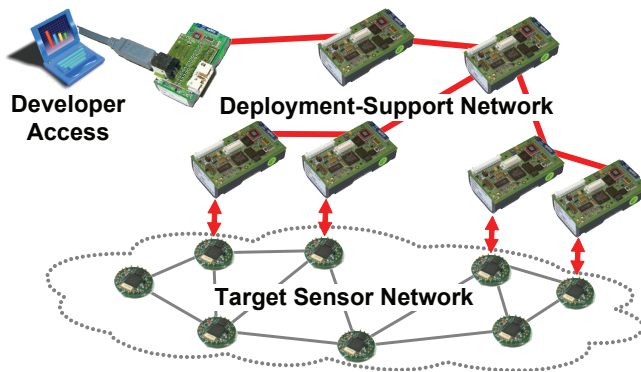

Figure 1: A deployment-support network is temporarily attached to an experimental target network and facilitates long-term surveillance and maintenance using the SNM toolkit. A developer can access the DSN resources at any point using the Bluetooth backbone network.

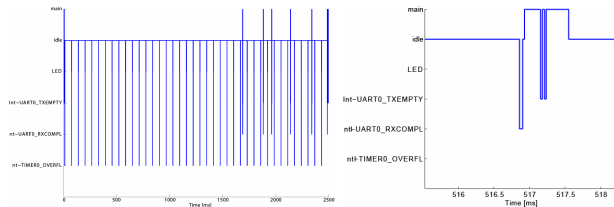
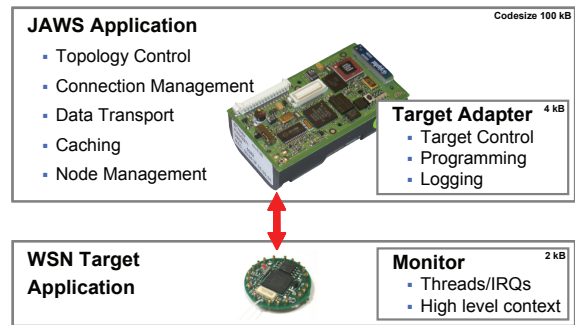

Figure 2: The BTnut OS tracer allows to track critical real-time issues on a target device with minimal influence on the actual timing behavior.

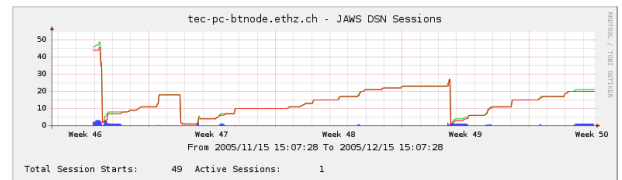

Figure 3: Long-term logging and online analysis of the DSN functions using cacti and rrdtool.

allow flexible access to the resources of the DSN both in a centralized fashion optimized for logging (server) and in a mobile maintenance scenario.

### 3.3 Remote Logging and Event Detection

The target adapter on the DSN nodes is equipped with a remote logging facility that can store and time-stamp events generated by the target devices. These logs can be retrieved from all DSN nodes to a central location on demand for subsequent analysis. Furthermore, filters can be set on a per-node basis to send notifications of certain events, e.g. warnings, errors, etc. to the control GUI running on the generic DSN access. Time-synchronization between all DSN nodes allows for easy correlation of the distributed event streams gathered by the deployment-support network.

A simple BTnut OS tracer event facility can be installed on the target devices application for tracing low-level events at fine granularity and without unduly disturbance to the target systems timing behavior (see Figure 2).

### 3.4 Long Term Logging and Data Analysis

Using the generic DSN access infrastructure, data from long-term experiments can be logged into both files and a MySQL database. The sensor network monitoring toolkit allows to create simple, yet powerful queries based on the DSN interface specification that can be executed repeatedly at the server where the resulting data is stored and converted into webpages and graphs using cacti and rrdtool, an online data

analysis and plotting toolset (see Figure 3).

## Acknowledgments

We would like to acknowledge the tireless implementation and debugging work performed by Philipp Blum, Daniel Hobi, Lukas Winterhalter, Mustafa Yücel and Sven Zimmermann.

The work presented here was supported by the National Competence Center in Research on Mobile Information and Communication Systems (NCCR-MICS), a center supported by the Swiss, Matthias Ringwald National Science Foundation under grant number 5005-67322.

## 4. REFERENCES

- [1] J. Beutel, M. Dyer, M. Hinz, L. Meier, and M. Ringwald. Next-generation prototyping of sensor networks. In *Proc. 2nd ACM Conf. Embedded Networked Sensor Systems (SenSys 2004)*, pages 291–292. ACM Press, New York, Nov. 2004.
- [2] J. Hui and D. Culler. The dynamic behavior of a data dissemination protocol for network programming at scale. In *Proc. 2nd ACM Conf. Embedded Networked Sensor Systems (SenSys 2004)*, pages 81–94. ACM Press, New York, Nov. 2004.
- [3] G. Werner-Allen, P. Swieskowski, and M. Welsh. MoteLab: A wireless sensor network testbed. In *Proc. 4th Int'l Conf. Information Processing in Sensor Networks (IPSN '05)*, pages 483–488. IEEE, Piscataway, NJ, Apr. 2005.

# Demo Abstract: BASUMA - A Body Sensor System for Tele-medicine\*

J.-P. Ebert, D. Dietterle  
IHP GmbH  
Wireless Comm. Systems  
Im Technologiepark 25  
D-15236 Frankfurt (Oder)  
ebert|dietterle@ihp-ffo.de

M. Lang  
TES Electronic Solutions  
GmbH  
Zettachring 8  
D-70567 Stuttgart  
marcus.lang@tesbv.com

T. Falck, J. Espina  
Philips Technologie GmbH  
Forschungslab. Aachen  
Weisshausstr. 2  
D-52066 Aachen  
thomas.falck|javier.espina@philips.com

## ABSTRACT

BASUMA stands for Body Area System for Ubiquitous Multimedia Applications. Although the system is designed to support various applications, which use wireless body area communication, the pursued applications scenario is closely related to Body Sensor Networks (BSN). In particular, we are developing a BSN for the purpose of long-term monitoring of COPD patient (Chronically Obstructive Pulmonary Disease). The poster will describe shortly the project structure and in more detail the use case, the system concept and architecture, implementation/hardware/software issues and intermediate project results. The poster is accompanied by the a concept demonstrator showing medical sensors and wireless communication capabilities.

## 1. BASUMA

The application of sensor networks in health care has attracted much research work ([1], [2]) in recent years. Advances in system-on-chip (SoC) design and wireless communication technology enable the development of tiny, battery-powered sensor nodes that can be worn on the human body. Wireless communication among the sensors and to external medical devices allow patients to move more freely in a hospital environment or even return to their homes while their health is being monitored.

This can lead to cost savings due to shorter stays in a hospital and to an increased quality of life. Furthermore, long-term continuous health monitoring for chronically ill patients or patients belonging to a risk group helps to diagnose symptoms of a disease much earlier than at regular or emergency visits of a doctor.

Several technological challenges have to be faced before a working health monitoring system can be deployed. One aspect concerns the development of miniaturized biomedical sensors that are battery-powered and still provide sufficient accuracy. Moreover, new algorithms for diagnosing the patient's health state based on possibly inaccurate, however continuous sensor measurements and combining measurements from different sensors have to be designed and validated in practice. Reliability of the system is another major concern as it must operate correctly without human

intervention for several weeks or months under any circumstances. The long operating times without replacing batteries requires an efficient system and the application of effective power management strategies.

All these requirements require a robust wireless system with low power consumption. Ultra-WideBand (UWB) pulse radio technology is selected as a promising candidate for achieving wireless networking connectivity. The relative simplicity of UWB transceivers will have several benefits like low power consumption and low cost. The "spread" of the spectrum leads to a robust wireless system – features that are postulated by a medical body area communication system. In addition to UWB, we pursue an alternative approach, which is based on Orthogonal Frequency Devision Multiplexing (OFDM).

These challenges are addressed by the BASUMA (Body Area System for Ubiquitous Multimedia Applications) research project [3]. Within the scope of this interdisciplinary project, novel biomedical sensors and medical algorithms for the evaluation of sensor readings as well as a generic wireless communication platform is being developed.

The ultimate goal of the project at the end of the year 2007 is a fully operable wireless BSN consisting of a tiny single chip solution (SoC) that runs the medical software and middleware and sensors, which are applied in a field test.

## 2. POSTERS

We plan a poster describing the project, technical challenges, approaches, solutions and goals

**BASUMA Application and Middleware** Description of Medical Application and Middleware concept and software

**BASUMA Sensor Node Platform** Description of the BASUMA hardware architecture, implementation issues and solutions

**BASUMA Sensors and Medical Cases** Description of sensors and medical use cases

**BASUMA UWB wireless technology** Simulation results with the IEEE 802.15.4a channel model for communication between sensors located on the human body;

\*The work presented herein is partly funded by the Bundesministerium für Wirtschaft und Arbeit (BMW), Germany.

Concept of an UWB system and design of an UWB transceiver IC

### 3. DEMO

Although the BASUMA software, hardware and sensors are still under development - the first prototype will be available in the 1st quarter of 2006 - we show first results by means of a concept demonstrator. This demonstrator is based on a 802.15.4 platform connecting wirelessly various medical sensors (pulse,  $SpO_2$ , ECG, etc.) to a remote monitoring device.

### 4. ADDITIONAL AUTHORS

Frieder Scheller, Universität Potsdam, Prof. f. Analytische Biochemie, Karl-Liebknecht-Str. 24-25, D-14476 Golm, [fschell@rz.uni-potsdam.de](mailto:fschell@rz.uni-potsdam.de)

Günther Uhlich, ABS Gesellschaft für Automatisierung, Bildverarbeitung und Software mbH, Erlanger Allee 103, D-07747 Jena, [info@abs-jena.de](mailto:info@abs-jena.de)

### 5. REFERENCES

- [1] E. Jovanov *et al.* "A wireless body area network of intelligent motion sensors for computer assisted physical rehabilitation," in *Journal of Neuroengineering and Rehabilitation*, 2(1):6, 2005
- [2] R. Bults *et al.* "Body Area Networks for Ambulant Patient Monitoring Over Next Generation Public Wireless Networks," in *Proc. 3rd IST Mobile and Wireless Communications Summit*, 2004
- [3] (2005). BASUMA - Body Area System for Ubiquitous Multimedia Applications. [Online]. Available: <http://www.basuma.de>



# Demo Abstract: Interactive In-Field Inspection of WSNs

Matthias Ringwald  
Institute for Pervasive  
Computing  
ETH Zurich  
mringwal@inf.ethz.ch

Mustafa Yücel  
Institute for Pervasive  
Computing  
ETH Zurich  
yuecelm@student.ethz.ch

Kay Römer  
Institute for Pervasive  
Computing  
ETH Zurich  
roemer@inf.ethz.ch

## 1. INTRODUCTION

We demonstrate a tool to inspect nodes of a deployed wireless sensor network (WSN) in the field. While an operational WSN can be remotely monitored via multi-hop routing, a newly deployed network often does not work as expected (e.g., multi-routing is broken). Here the developer needs to inspect single nodes in the field, carrying along necessary tools such as laptop and multi-meter.

An in-field inspection tool on a compact device does not only simplify the process of collecting information about the nodes' state but also enables the actual users of the WSN to perform routine checks or to upload new firmware versions. Our tool running on a standard PDA allows to:

- Re-task nodes by uploading a new firmware image
- Query system and application specific attributes
- Display the topology of the network and execute commands on nodes

We will first provide an overview on the hard- and software of our prototype, then assess how sensor nodes can be accessed and selected for inspection. Finally, we will give a brief description of the provided services and mention related work.

## 2. SYSTEM OVERVIEW

For this prototypical implementation we wanted to use hard- and software which is known to work and easy to use while trying to be close to actual sensor networks. We chose the deployment-support network (DSN) application running on BTnode rev3 nodes[1] as an exemplary WSN application to incorporate our new inspection services.

The BTnode is similar to the Berkeley Mica2 mote but contains an additional Bluetooth radio module and 256 KByte of external SRAM memory. On this hardware, the BTnut system software provides a Bluetooth stack and other services on top of the non-preemptive multithreaded Nut/OS. It includes event signaling, timer, dynamic memory allocation and POSIX-like streaming I/O.

The inspection tool was developed in Java and runs on Familiar Linux 0.8.3 (prerelease) on an HP iPaq H5450.

## 3. ACCESSING SENSOR NODES

In order to inspect a particular sensor node, we need to be able to communicate with it. Basically, there are three different ways to access a sensor node:

1. Cable: A physical connection allows for direct communication with a node. Although this is convenient during development and testing with a limited number (< 20) of nodes in the lab, it gets impractical when the nodes are actually put in enclosures and deployed in the environment or their number increases.
2. Normal radio interface: The radio used for the node's wireless communication can also be used to implement inspection services without extra hardware. By using the same radio, the service communication might interfere with other communication and influence the nodes' operation.
3. Extra radio interface: Adding a second radio overcomes the radio interference problem of the previous approach but introduces a scheduling issue of how and when the additional radio is activated.

The chosen DSN application already provides and maintains a reliable Bluetooth scatternet. In order to communicate with a normal PDA, we chose to use the Bluetooth communication also for the inspection services, hence following the second approach.

## 4. SENSOR NODE SELECTION

Using wireless communication, the user could interact with a potentially large number of nodes in communication range and has to select a single node or a set of nodes to interact with. This selection can be based on an explicit ID (e.g. "what's this node with ID 17 here doing?"), on a certain feature or a predicate ("Let's check nodes with low battery"), or on their physical location.

Independent from the selection criteria, it is beneficial that a selected node provides some feedback to the user, for example, to identify the physical node which has been selected. Common ways to provide feedback are to flash an LED or to emit audible noise.

In our prototype, we used the Bluetooth inquiry mechanism to collect a list of nodes in range. Among those, one or more nodes can be selected based on their MAC address which is printed on the node. Upon selection of a node, its LED flashes as acknowledgment. Using the topology service described later other nodes from the multi-hop network can be selected for inspection, too.

## 5. SERVICES

We implemented three basic services: re-tasking, attribute query and topology visualization for the inspection tool. On the BTnode, they are available as separate modules. This

had been greatly simplified by the used Bluetooth L2CAP protocol and the use of one Nut/OS thread per service. The main application now can instantiate any combination of services to be available via Bluetooth.

## 5.1 Re-tasking

Every sensor node has its application stored as a firmware image in the microcontroller's flash ROM. On the BTnodes, a wireless firmware upload can be implemented by downloading the new firmware into the external SRAM. Upon reboot, the boot loader then writes the new image into the flash ROM.

We have implemented an L2CAP service that handles the download and the storage of the new firmware image. The PDA allows to select a firmware image and a set of nodes to which the new image is uploaded.

## 5.2 Attribute Query

The attribute query service provides access to important system and application information of the sensor nodes. Examples for vital system attributes are battery voltage, available heap memory, number of running threads or the node's uptime. Current sensor readings, their polling interval or network statistics are examples for application-specific attributes.

As a mechanism to provide access to such attributes in a generic way, we created an attribute registration module at which the main application can activate system attributes or register their own. An attribute consists of a human-readable name and an access function which has to return the current value as text. We choose to use text for both attribute names and values to provide access to the attributes without detailed application-specific knowledge. The result from the access function could be the current value of a global variable or the result of a more complex calculation.

The attribute registration does not provide any means of communication. In our implementation, an L2CAP attribute-retrieval thread is used to provide the attribute query service via Bluetooth. The PDA retrieves the list of available attributes from the sensor node and presents it to the user who can then request the value of particular attributes.

## 5.3 Topology Viewer

The visualization of the network topology is a valuable tool for network maintenance and to debug routing problems. But as the network topology depends on the particular WSN application, the topology information cannot be provided without help from the application.

Obviously, the implementation of this service needs to be adapted to the particular network used. The used DSN did already provide a topology scan function so we could display its tree topology as shown in Figure 1.

## 6. RELATED WORK

The idea of using a PDA for field-inspections was mentioned before in several publications and a PDA has already been used in the TASK project[2]. The TASK field tool provides the ability to ping a single node, issue a command to turn on an LED or a buzzer or to reset the node.

The Nucleus Sensor Network Management System (SNMS) [3] allows the query of system and application state of nesC TinyOS applications. Its integration with nesC allows to remove attribute names from the firmware image by encoding

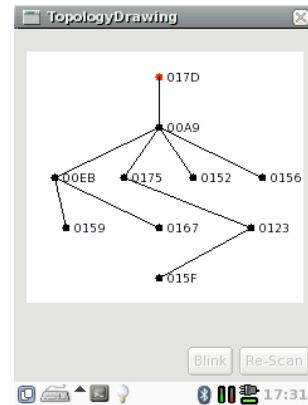

Figure 1: Topology view of the DSN application running on a Linux iPaq H5450.

them as numbers but requires to have the correct decoding information available when the query is performed.

## 7. DEMO SETUP

The demo setup consists of a large table with roughly 20 BTnodes and 1-2 HP iPaq H5450 devices.

The provided PDAs allow interested visitors to interact with single nodes or the complete DSN BTnode network. On the first GUI window, the user can perform an inquiry to get a list of available sensor nodes. To perform a firmware download, the set of nodes to be reprogrammed and the new firmware image has to be selected. Then, the firmware is uploaded to the selected nodes one by one.

In the attribute retrieval dialog, the user can select a single node for inspection. After establishing a connection to the node, the PDA displays the list of available attributes. Upon selection of an attribute, its current value is displayed.

The topology mode allows to gather topology information from the DSN network and displays it on the PDA. For this, a connection to one node of the network needs to be established. This view also allows to let all nodes or only single node blink or select a single node for attribute querying.

## 8. ACKNOWLEDGMENTS

The work presented in this paper was supported (in part) by the National Competence Center in Research on Mobile Information and Communication Systems (NCCR-MICS), a center supported by the Swiss National Science Foundation under grant number 5005-67322.

## 9. REFERENCES

- [1] J. Beutel, M. Dyer, L. Meier, and L. Thiele. Scalable topology control for deployment-sensor networks. In *Proc. 4th Int'l Conf. Information Processing in Sensor Networks (IPSN '05)*, pages 359–363, April 2005.
- [2] Phil Buonadonna, David Gay, Joseph M. Hellerstein, Wei Hong, and Samuel Madden. Task: Sensor network in a box. In *EWSN 2005*, pages 133–144, Istanbul, Turkey, Jan 2005.
- [3] Gillman Tolle and David Culler. Design of an application-cooperative management system for wireless sensor networks. In *EWSN 2005*, pages 121–132, Istanbul, Turkey, Jan 2005.



## **Sentient Future Competition: Winners**

# Sentient Future Competition: Introduction

George Coulouris  
University of Cambridge  
United Kingdom  
gfc22@cam.ac.uk

Marcelo Pias  
University of Cambridge  
United Kingdom  
marcelo.pias@cl.cam.ac.uk

Irina Pienis  
Technical University of Berlin  
Germany  
piens@prz.tu-berlin.de

## 1. OVERVIEW

In the near future many parts of our environment will include a plethora of sensor nodes - very small, inexpensive computers equipped with devices for sensing or receiving information about the physical world in which they are located and performing simple actions. Sensor nodes communicate with each other and with other computers by wireless networking. They exchange information to perform more complex actions. Nodes that interact to perform tasks cooperatively in a manner that has a real effect are called Cooperating Objects (CO). For example, cars may detect the presence of other vehicles or pedestrians and transmit information about their presence to other nearby cars which may slow down when children are present, or when there is a lot of traffic ahead.

The European-funded project Embedded WiSeNts<sup>1</sup> is preparing a research roadmap in the area of Cooperating Objects to identify important research problems that need to be addressed. To guide this roadmap preparation, we are required to foresee the most promising visions for innovative applications.

To shed light on this, the Sentient Future Competition challenged the members of the public to find interesting applications that we can expect to have in 10 years from now once all the basic CO technologies are in place. The competition, an initiative of the Embedded WiSeNts with sponsorship of Deutsche Telekom Laboratories<sup>2</sup>, was launched on the 1<sup>st</sup> Oct 2005 and the results were announced on the 18<sup>th</sup> Jan 2006.

The judges and reviewers faced a tremendous challenge to evaluate the high quality application scenarios received. All entries were rigorously reviewed by three members of a panel composed of 24 reviewers, who prepared a short list. The shortlisted scenarios were then carefully reviewed by all members of the distinguished judging panel who made the final decision including the first prize winner, second and third runner-ups along with 9 commended applications. The entries were evaluated against the criteria of originality of concept, innovation and technical progress, and impact - social, economic and environmental. This volume contains the winning entries and 7 of the highly commended applications.

<sup>1</sup><http://www.embedded-wisents.org>

<sup>2</sup><http://www.telekom.de/laboratories>

**The Sentient Future Competition\***  
click here for Rules und Regulations

▶ imagine the future 10 years from now  
▶ envision a scenario for wireless sensor networks and cooperating objects

**win cash!** ▶ win up to 6,000 € in cash

\* created by the Embedded WiSeNts coordination action and sponsored by the Deutsche Telekom Laboratories competition opening October 1<sup>st</sup>, 2005, apply until November 30<sup>th</sup>, 2005

Deutsche Telekom Laboratories  
Institut der Technischen Universität Berlin

Embedded WiSeNts  
Information Society Technologies

The Embedded WiSeNts Sentient Future Competition Judging Panel is happy to announce the final results as follows. Prizes have been awarded in a special session of EWSN 2006.

## 2. WINNERS

**1<sup>st</sup> Prize: € 6000**

### **Large Scale Body Sensing for Infectious Disease Control**

*Markus Endler (Department of Informatics, Pontifícia Universidade Católica do Rio de Janeiro, BR).*

**2<sup>nd</sup> Prize: € 3000**

### **BIN IT! The Intelligent Waste Management System**

*David Schoch (Student of Geography, University of Zurich, Switzerland), Matthias Sala (Student of Computer Science, ETH Zurich, CH).*

**3<sup>rd</sup> Prize: € 1000**

### **Vision of Congestion-Free Road Traffic and Cooperating Objects**

*Ricardo Morla (PhD student in Computer Science, Lancaster University and Researcher, INESC Porto, PT).*

## 3. HIGHLY COMMENDED ENTRIES

### **Ambient Intelligence by Collaborative Eye Tracking**

*Eiko Yoneki (University of Cambridge, UK).*

#### **A Day in the Life of a not too Distant Future**

*Phillip De Caux (University of Liverpool, UK).*

#### **Embedded WiSeNts & Agnostic Algorithms of Creation**

*Panagiotis Bairaktaris (City University, UK).*

#### **Father in Womb**

*Tiago Camilo, André Rodrigues, Jorge Silva, F. Boavida (University of Coimbra, PT), Eduardo Sá (Superior Institute of Applied Psychology, PT).*

#### **LocuSent - locust control**

*Milo Lavén (ArtCore Stockholm, SE).*

#### **PerSens: Personality Sensors**

*Zinaida Benenson, Mesut Güneş, Martin Wenig (RWTH Aachen University, DE).*

#### **Sentient Guardian Angel**

*Marcus Christ, Gerald Eichler, Klaus Miethe, Stefanie Richter, Jens Schmidt, Jens Wukasz (DE).*

#### **SmartSoot**

*Patrick Andrews (Break-step Productions Ltd, UK).*

#### **WISPHER: cooperating Wireless Sensors for the Preservation of artistic HERitage**

*Franco Raimondi (University College London, UK), Davide Del Curto (Politecnico di Milano, IT).*

### **4. JUDGING PANEL**

George Coulouris, Cambridge University (chair)  
Philippe Bonnet, University of Copenhagen  
Andy Hopper, Cambridge University  
Friedemann Mattern, ETH Zurich  
Pete Steggle, Ubisense Ltd.  
Christian Wolf, Deutsche Telekom Laboratories  
Adam Wolisz, Technical University of Berlin

### **5. REVIEWERS**

Michel Banâtre, INRIA  
Sebnem Baydere, Yeditepe University  
Philippe Bonnet, University of Copenhagen  
George Coulouris, University of Cambridge  
Laura Feeney, Swedish Institute of Computer Science  
Vlado Handziski, Technical University of Berlin  
Paul Havinga, University of Twente  
Eric Jul, University of Copenhagen  
Maria Lijding, University of Twente  
Pedro Marrón, University of Stuttgart  
Friedemann Mattern, ETH Zurich  
Ivan Maza, University of Seville  
Nirvana Meratnia, University of Twente  
Daniel Minder, University of Stuttgart  
Anibal Ollero, AICIA-University of Seville  
Chiara Petrioli, University of Rome "La Sapienza"  
Kay Römer, ETH Zurich  
Silvia Santini, ETH Zurich  
Roland Schwaiger, Deutsche Telekom Laboratories  
Pete Steggle, Ubisense Ltd.  
Thiemo Voigt, Swedish Institute of Computer Science  
Christian Wolf, Deutsche Telekom Laboratories  
Adam Wolisz, Technical University of Berlin  
Andrea Zanella, University of Padova

### **6. ACKNOWLEDGMENTS**

We thank the *Deutsche Telekom Laboratories* for sponsoring and promoting the *Sentient Future Competition*.

# ***Sentient Future Competition***

## **Large scale body sensing for Infectious Disease Control**

Markus Endler  
Department of Informatics  
Pontifícia Universidade Católica do Rio de Janeiro  
R. Marquês de São Vicente, 225  
22453-900 - Rio de Janeiro, Brazil  
endler@inf.puc-rio.br

### **1. SENSOR NETWORKS TO SOLVE MAJOR PROBLEMS**

In the last decades, computer researchers have come up with several applications for wireless and sensor technology that are strongly focused on military activities, (personal and corporate) productivity-enhancing processes, or entertainment, many of which, we believe, are less urgent than other global problems like Uncontrolled Population Growth, Non-sustainable use of natural resources, Natural Disaster Relief, and Infectious Disease Control. Hence, we claim that these other problems should become the agenda of future research and development in this area.

In this sense, we chose one of these problems - Infectious Disease Control - and in the following outline a possible future use of sensor networks for monitoring and controlling infectious diseases in large animal (and maybe also human) populations. Because of the several intricate ethical issues involved in monitoring humans, we prefer to explain our application in terms of non-human populations.

The recent news about the Avian influenza disease have shown how fast a mutant and lethal virus disease can spread around our globe, putting in danger large populations of humans.

On the other hand, the relatively large incubation time of the virus makes it difficult to detect infected animals at an early stage. Therefore, large amounts of animal must be pro-actively sacrificed at any suspicion of an infection.

The other problem is of scale. Since our society is raising animals (cattle, pork, chicken) in such a large scale in an industrial setting (with insufficient space and feeding them badly) we have become unable to monitor each animal's health, and avoid the spreading of diseases at early stages.

Hence, in our point of view it would be very important to develop sensors and an infra-structure that could continuously monitor the health conditions of large-scale animal populations regardless of their location. And using sophisticated methods for automated diagnosis, one would enable warnings of disease or infection suspects, and allow for early control measures by the farmers or the agricultural authorities.

This problem area is particularly important in Brazil, since a significant part of its economy is based on the export of food and meat. For instance, Brazil is the world's biggest exporter of cattle meat handling US\$ 2,5 bilions annually. However, because of the current incidents of aftosa fever in some regions of Brazil in 2005, there will be a lost of about US\$ 270 millions.

### **2. REQUIRED TECHNOLOGY**

With the miniaturization of chips, soon it will be possible to produce penny-size body sensors with small flash memory and short-range wireless communication capabilities. These sensors could be attached to (or implanted in) specific parts of animal, and would be able to probe physical (e.g. temperature, ECG, blood pressure), chemical (e.g. pH, toxins) and biological (e.g. glucose, protein) properties of the body.

This data would be stored in the on-chip memory, and could be transferred through the wireless interface to *collector nodes* (at base-stations installed at gateways or close to the food or water dispensers) as soon as the animal gets close to such a base-station. These base-stations would have a wireless connection to the farmer's office computer, where all the collected data would be analyzed and visualized by specific software for infectious disease control.

The chip would carry the animal's identification and other data, such as age, gender, etc. Moreover, each time two animals get close to each other, the corresponding chips would also exchange data, in order to register this encounter on each chip. This would help to detect whether there is some possibility of infection among two animals.

The chips would have very low power consumption (e.g. few  $\mu$ Watts), and would be powered by several, complementary energy sources, such as battery, solar energy, motion or thermal energy. Such sensors with integrated low-cost radio interfaces, called Ultra-low Power Radios (ULPR), are already being developed [2]. They use specific propagation in and around a body using specific characteristics of biological tissue, and are powered by micro-generators [1].

Some future versions of such chips may also be equipped with GPS sensors, allowing to track the exact location of each animal.

### 3. SCENARIO

The following scenario illustrates the use of the envisaged technology (let's call it the *Animal Health Monitoring System - AHMS*) in controlling and avoiding the spread of infectious diseases at an early stage:

Consider a cattle farm with a large number of cows (e.g. 20,000 or more), where the animals are regularly moved among several pastures, and where all of the cows are equipped with the AHMS measuring glucose and toxin levels. Moreover, consider that some of the pastures are at the border to another country, where sanitary control is much more relaxed<sup>1</sup>, and where some cows have an infectious disease which can be diagnosed by a sudden, but short period of high body temperature.

By continuous monitoring the toxin levels of all the cows, the farmer may early detect that there is some problem with the food or water given to the cattle. Additionally, with AHMS a farmer would be able to monitor the daily temperatures of his animals, and as soon as some animals in the border pasture get the symptoms of the disease, the farmer would be able to conclude that some of his cows have probably been infected. He would then isolate the infected animals from the others, or if necessary, sacrifice them in order to avoid further spread of the infection.

Even for the case that the health problems of an animal disease show up only when the meat is consumed, the AHMS could be used for tracing the health condition history (and the behavior) of the animal(s) who's meat caused the health problems. In fact, this could also help to identify characteristic symptoms of unknown diseases and be used by government agricultural agencies for generating cattle health certifications.

Additionally, by using location technologies the scenario can be even more interesting for disease control. For example:

- If the AHMS chips had GPS sensors, the farmer would even be able to detect where most probably is a hole in the fence that allows his cattle to get into close contact with the cattle of the neighbor farm.
- By tracking which other animal has been in contact with the infected ones some days before or after the suspicious symptoms were detected, the farmer would be able to widen the group of animals to be isolated or sacrificed.

### 4. MAIN TECHNOLOGICAL CHALLENGES

In spite of the many benefits that such application might bring, unfortunately, so far, the required technology is not sufficiently accurate and reliable for such a use. In the following, we point to what we believe are the major technological challenges that have to be overcome.

<sup>1</sup>This is the probable cause of the recent aftosa fever in some regions of Brazil.

#### 4.1 Improvement of sensors for biological and chemical measurements

It is well known that several diseases can be detected diagnostically only through very specific analysis of blood (or other body substances), through detection of external symptoms, or a combination of both. For the former case, sensors would have to be much more sophisticated and would have to have access to blood veins or body organs, etc. Despite the several significant advances in medicine, we believe that there still are a strong demand of research effort in order to enable the development of cheap sensors for "deep body monitoring".

#### 4.2 Detection of externally visible symptoms

As mentioned, many diseases are characterized by a combination (and timely correlation) of internal and external symptoms, and hence cannot be properly identified measuring only physical, biological, or chemical data. For example, the Malignant catarrhal fever has external symptoms such as nasal and ocular discharges, conjunctivitis, drooling, hematuria, necrosis and blunting of buccal papillae, enlargement of lymph nodes, diarrhea, among others [4]. Since it is virtually impossible to instrument an animal with sensors to detect all such kinds of symptoms, it would be necessary to identify such symptoms by other means, such as through video cameras, etc. However, such automated detection of external symptoms at individual animals within a large groups is certainly a complex problem in image recognition.

#### 4.3 Development of micro-size and cheap power generators

Despite the current efforts to produce motion and thermal power generators, so far these are still very expensive to be deployable in large scale, and too big and heavy to be attached to or implanted in animal bodies. Here we envision need of strong interdisciplinary research in several areas of health and natural sciences.

#### 4.4 Low-power radio transmission

In recent years, several advances in low-power (and low-range) radio transmission have been done. More recently, the wireless technology ZigBee [3] has been announced, but according to specialists it's communication efficiency and power consumption are still inappropriate for simple sensor networks. Hence, not only hardware must improve, but research must also be done in communication protocols for efficient and opportunistic wireless transmissions.

#### 4.5 Dealing with sensor outage

Sensors, in general, may fail due to many possible problems, ranging from lack of power supply to physical damage. This is the reason why traditional sensor network research counts on redundant nodes and resources. The problem with body sensors is that, so far, they are not cheap and tiny enough so that an animal could be *instrumented* with many of them. On the other hand, data from each individual animal is necessary for a complete monitoring of a herd of animals. Therefore, body sensors must still become smaller and cheaper (and have a reliable power source) so that they can be used for such application.



#### 4.6 Dealing with unreliable wireless communication and unpredictable movements

It is well known that short-range wireless communication is very unreliable, not only because of radio interference, but also because nodes (sensors) may be in constant move. For body sensors, this is even worse, as animals move in unpredictable ways and sometimes gather at some places, creating “natural” obstacles for both peer-to-peer and sensor-to-base-station communication. Therefore, we believe that much R&D must be done for creating efficient, and more robust (multi-hop) communication protocols for sensor networks.

### 5. CONCLUSION

In this position paper we presented our vision of a future application of sensor and wireless technology that would be useful for dealing with the acute and important problem of infectious disease control. Similarly, there are also many other important and complex real-world problems, such as environmental protection, natural disaster forecast and relief, etc. which may save many lives today, and/or guarantee life of future generations, and which should be the focus of current (inter-disciplinary) research and development.

### 6. REFERENCES

- [1] IMEC. Micro-power generation: R&d fact sheet. Web page.  
<http://www.imec.be/human/brochures/micropower.pdf>  
(Last visited: October 2005).
- [2] IMEC. Ultra low-power radios. Web page.  
<http://www.imec.be/wireless/ulp-radio/> (Last visited: October 2005).
- [3] G. Legg. Zigbee: Wireless technology for low-power sensor networks. Web page, May 2004.  
[http://www.techonline.com/community/ed\\_resource/-feature\\_article/36561](http://www.techonline.com/community/ed_resource/-feature_article/36561) (Last visited: October 2005).
- [4] R. R. Rech, A. L. Schild, D. Driemeier, and et al. Malignant catarrhal fever in cattle in rio grande do sul, brazil: epidemiology, clinical signs and pathology. *Pesq. Vet. Bras.*, 25(2):97–105, June 2005.

# Sentient Future Competition: *BIN IT!* – The Intelligent Waste Management System

David Schoch  
University of Zurich  
Switzerland

d.schoch@access.unizh.ch

Matthias Sala  
ETH Zurich  
Switzerland

salam@student.ethz.ch

## ABSTRACT

Littering is an urgent problem in urban environments. Therefore, a more efficient and sustainable waste management system can implicate a higher life quality and less costs for the city authorities. We propose an RFID system that tracks pieces of waste and encourages the correct disposal by financial incentives. Our solution is easily realisable and stands out by its high social, economic and ecological relevance.

## 1. MOTIVATION

Around the globe, more and more litter is being thrown away carelessly or dumped illegally in streets, in public spaces or in nature. Littering and the wrong waste disposal respectively affect adversely the public order, lead to higher costs for the cleaning teams and to a diminished quality of life for society. This emerging trend has to be given due attention and appropriate measures have to be launched to counter it.

In many countries, state authorities have been working on concepts to give incentives against littering and the incorrect waste disposal. But often these campaigns tend to fall on deaf ears in society because the waste management is often organised in a far too complicated way and there are not enough incentives for a social, economic and ecological waste management. This is the reason why we have developed an intelligent waste management system that allows city authorities to tackle the problem at its roots, this means on the street or at other neuralgic places, there where littering is most obvious.

## 2. PROPOSED SOLUTION

We imagine that in the future the littering problem can be solved using the tracking possibilities given by the RFID technology [1]. The person who disposes the waste is in possession of a *collection card*. Is he or she throwing a piece of *waste* in a *bin* or disposing recyclable material in a *recycling container*, the *bin* or *recycling container* identifies it and a certain deposit will be credited to his or her *collection card*.

The intelligent waste management is based on four *cooperating objects* described in the following subsections:

### 2.1 Waste

All different kinds of consumption goods like packages of fast food restaurants, tetra packages, bottles, jam jars, cans, batteries, etc. get equipped with standardised RFID tags in the factory when they are produced.

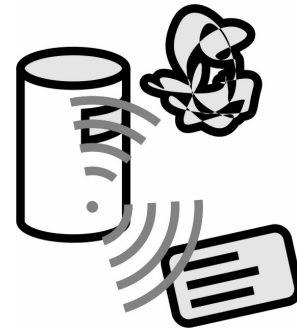

Figure 1: Wireless communication between waste, bin and collection card.

### 2.2 Bin & Recycling Container

The bins and recycling containers are inwardly provided with a reader and a writer. The bins are distributed all over the cities as usual. All objects that are not meant to be recycled can be dumped there. The recycling containers are allocated at central and highly accessible locations, but they do not have the same geographical distribution density as the bins.

### 2.3 Collection Card

The collection card has the same size as a credit card and has an embedded writable RFID chip. Collection cards are nonpersonal and are available at no charge.

### 2.4 Refund Station

Refund stations are explicit desks, specialised vending machines or retailers (e.g. fast food restaurants) equipped with RFID readers and writers and connected to the global waste directory. The amount collected with the collection card is refunded here.

## 3. STEPS IN DETAIL

Figure 2 shows the cycle of waste within the intelligent waste management system in more detail. It includes the following steps:

**Production (1)** The product gets equipped with a standardised RFID tag and the number is registered in a global directory.

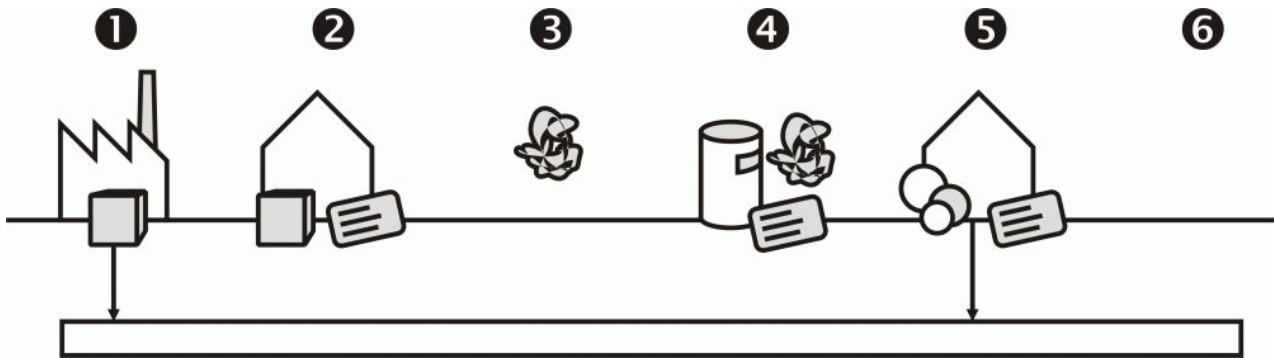

Figure 2: Cycles within the intelligent waste management system.

**Purchasing (2)** The product is bought by a consumer. The consumer receives a collection card.

**Waste Arising (3)** The product is used and waste is produced.

**Waste Disposal (4)** The waste is dumped in a bin or in a recycling container and the corresponding number is stored on the collection card.

**Refundment (5)** The amount refunded is calculated on the basis of the numbers on the collection card. The numbers of the disposed objects are removed from the global directory.

**Recurrence (6)** This cycle recurs at any time. The collection card can be used further on.

## 4. SUSTAINABILITY

On the whole, this visionary scenario is easily realisable and modifiable. It draws on all of the *three pillars of sustainability* [2].

### 4.1 Social

In general, the appropriate disposal of waste is of very high importance for society. The sensitisation of society for a sustainable treatment of the environment is an indicator of the prosperity of a country and it helps to strengthen the **well being** of its population. The intelligent waste management system generates a certain climate on the street that influences the waste offenders in a positive way. We can also imagine that certain persons would be attempted to collect the waste of others.

### 4.2 Economic

The immense costs of waste disposal that the state has to pay can be reduced by a systematic waste management policy. In states like Singapore, that maintain a very repressive policy, this system could lead to a rethinking. In addition, the producers profit from the lower production costs by the reuse of recyclable materials. But also the consumer side should be recompensed for the proper use of the waste management system by selective financial incentives. A **win-win situation** should be established.

### 4.3 Ecological

The use of the intelligent waste management system stops the further contamination of our environment and combats the **exploitation of non-renewable resources**.

## 5. POSSIBLE EXTENSIONS

The proposed infrastructure is adaptable for different needs, as described below:

If waste without an RFID tag or recyclable waste is thrown into a bin, **no money** will be transferred. This system can be expanded by defining which waste can be dumped in which bin or recycling container. The more products get equipped with an RFID tag, the more accurate and efficient it is.

To avoid possible financial fraud, a retailer such as a fast food restaurant may use the system to collect points (instead of money) in order to reward frequent clients (**customer retention**).

In a brave new world scenario, every piece of waste would be equipped with RFID tags. Therefore, an authority (e.g. the producer) could track back the origin of illegally disposed waste and **fine** the polluter on one's own account. This scenario however leads to some privacy concerns which are discussed in the next section.

## 6. DISCUSSION

Similarly to other RFID solutions [3] [4], **data privacy** is a severe issue. That is why we consider it as important to save only nonpersonal data on the collection card. This makes the collection card transferable from one person to another. As mentioned in section 5 above, a personalisation of the collection card could be implemented as a next step, at least for certain products.

To organise this waste management system efficiently it is important that many enterprises **participate**. Fast food restaurants (*Mc Donald's*, *Burger King*, *KFC*, etc.) that often suffer from their bad image concerning waste disposal management could profit a lot.

Further, to prevent the **abuse by the reuse** of a certain object, the reader has to be installed inside the bin or con-

tainer, so that the rubbish is not identified until it is inside and cannot be taken out again by people who try to cheat.

Additional security is given by the global directory that prevents multiple refundments. The refund station verifies each number on the collection card and deletes them from the global directory. If there is the same number on the collection card more than once, the corresponding amount is credited one time only. Therefore, a **fraud** cannot debit an item illegitimately, except he would be faster than the honest collector.

Whether the producer or the consumer has to **pay the deposit** is a controversial question as well. Concerning this matter, there are two possibilities. Either the client pays the amount of the deposit when he or she buys the item in terms of a tax rate (*polluter pays principle*) or the producer pays it. But the latter alternative is unlikely to happen without a price markup, unless the collecting card is linked to a customer retention system.

**Solar cells** on the top of the bins and recycling containers could provide the power supply for the technical equipment.

## 7. CONCLUSION

*BIN IT!*, the intelligent waste management system, is easily realisable from a technical point of view. On the other hand, it is of high social, economic and ecological relevance for society. These two factors combined give this visionary scenario great chances to be implemented. But the discussion shows as well that there would be some challenges to be accomplished, especially if this system should be dispersed over a large geographic perimeter.

## 8. REFERENCES

- [1] A. Niemeyer, M. H. Pak, and S. E. Ramaswamy. Smart tags for your supply chain. In *The McKinsey Quarterly*, Number 4, 2003. Found on <http://www.lwcresearch.com/filesfordownloads/Smarttagsforyoursupplychain.pdf> (accessed in January 2006).
- [2] G. H. Brundtland. *Our Common Future. World Commission on Environment and Development*. Oxford University Press, Oxford, 1987.
- [3] S. A. Weis, S. E. Sarma, R. L. Rivest, and D. W. Engels. Security and Privacy Aspects of Low-Cost Radio Frequency Identification Systems. In *Lecture Notes in Computer Science*, Volume 2802, 2004, Pages 201 – 212.
- [4] S. E. Sarma, S. A. Weis, and D. W. Engels. RFID Systems and Security and Privacy Implications. In *Lecture Notes in Computer Science*, Volume 2523, 2003, Pages 454 – 469.

# Sentient Future Competition: Vision of Congestion-Free Road Traffic and Cooperating Objects

Ricardo Morla  
Lancaster University and INESC Porto  
R. Roberto Frias, 378  
Porto, Portugal  
ricardo.morla@inescporto.pt

## ABSTRACT

This paper presents a vision of cooperating vehicles that help keep roads free of traffic congestion. This vision explores the concept of dynamic time-space corridor that can be negotiated between cooperating vehicles to guarantee congestion-free journeys from departure to arrival.

## 1. VISION

This vision of the future is motivated by the increasing traffic congestion around our densely populated metropolitan areas. There is no need here to reference the numerous studies on traffic safety and pollution carried out by governmental agencies over the years or to bring forward accident, carbon dioxide, and driver-stress figures. Everyone that has been in a large city in rush hour has most likely experienced how stressful it is to be locked in traffic, noticed the pollution in the air, considered how they could have been injured on the road, and wondered how much better their lives would be without traffic congestion.

Typical science fiction solutions to this problem of traffic congestion first come to mind, including for example the teleportation devices in Asimov's *It's Such a Beautiful Day* story or the ability to travel between alternate history Earths in Asimov's *Living Space* story. However, here we are not restrained only by our imagination but want to consider traffic congestion solutions that can plausibly be built within the next ten years. As such, we assume the following:

- In ten years, vehicles will be able to communicate, to sense their environment, to control their speed and direction, and in general to cooperate with each other.
- In ten years, numerous objects on the urban landscape will similarly be able to communicate and sense their environment – we are thinking for example of communicating and sensing signposts, sidewalks, and street lamps.

These seem reasonable assumptions. Manufacturers are already enhancing cars with sensors that help drivers to park and providing GPS compasses as standard equipment on luxury cars. Reasonably, full integration of on-board, software- and hardware-improved computers with wireless communications and environmental sensors is within ten years' reach. Furthermore, trials of numerous networked and sensing objects have been conducted in urban areas. This is a first

step towards the full deployment of such objects throughout cities and metropolitan areas.

Our vision is that traffic congestion can be prevented with the help of these cooperating vehicles and urban landscape objects. In particular, we see these cooperating objects helping people drive more intelligently – or rather more cooperatively – with the aim of preventing congestion. Some laboratory prototype vehicles may today already detect the proximity of other vehicles or obstacles and automatically break to prevent collisions, or detect traffic congestion ahead and suggest alternate routes to drivers. Our vision is that of a solution that is beyond what these prototype vehicles can do to alleviate traffic congestion. In particular, with the help of cooperating objects we expect to prevent congestion before it occurs, self-regulating traffic such that e.g. avoiding collisions and finding alternate congestion-free routes may no longer be necessary to prevent congestion. In our vision, cooperating vehicles help to self-regulate traffic by negotiating in advance a clear corridor in space and time that goes through the roads of their intended journey. Such a corridor is much like a Time-Division Multiple-Access (TDMA) data slot that propagates through a communications channel. A vehicle that obtains access to such a time-space corridor will not experience congestion as other vehicles will manoeuvre to keep such a corridor unobstructed. In our vision, all the vehicles in what otherwise would have been a traffic jam have their own time-space corridors and, as such, move without causing or experiencing congestion. This is the core of our vision of congestion-free road traffic.

The following sections describe in more detail the system that we have envisioned to support congestion-free road traffic using cooperating vehicles and urban landscape objects.

## 2. ENVISIONED SUPPORTING SYSTEM

### 2.1 Time-Space Corridor

The major concept of our vision is the time-space road corridor that we also term virtual vehicle slot. Virtual vehicle slots propagate through a lane of the road at the recommended speed of that lane (see fig. 1). Once a virtual slot is assigned to a vehicle it cannot be overrun by other vehicles. On one hand, vehicles moving in their virtual slots will not overrun the virtual slots of other vehicles as 1) the speed of virtual slots on the same lane is the same; and 2) virtual slots are long enough to guarantee a minimum safety distance between vehicles of consecutive slots. On the other hand, vehicles that have not been assigned a virtual slot will

have to avoid overrunning virtual slots by e.g. changing lane or increasing their speed. As such, a vehicle to which a virtual slot is assigned is guaranteed to arrive at its destination without experiencing traffic congestion. For example, we expect lane junction congestion to be prevented as virtual slots from incoming lanes are synchronised and propagate to the outgoing lane at the lane's recommended speed. Similarly, we expect that virtual slots will allow vehicles to maintain their speed and as such help prevent e.g. wave phenomena typical in traffic congestion in which vehicles periodically accelerate and then almost immediately have to break.

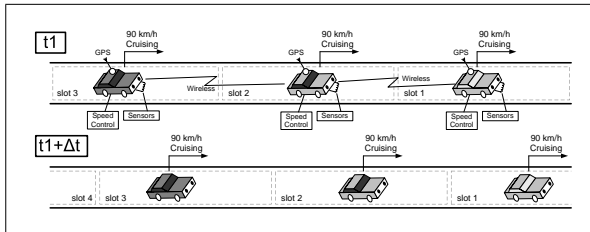

**Figure 1: Example of a single lane with moving virtual vehicle slots.** Notice how each slot moves forward with time at the recommended speed of the lane (90 km/h). Notice also that the vehicles communicate with each other, determine their position, sense their environment (e.g. proximity detection), and control their speed in order to keep to their moving virtual slots. (Note that cruising vehicles have zero acceleration.)

## 2.2 Cooperating Vehicles

In our vision, cooperating vehicles that can sense their environment will be able to implement this virtual slot system. These vehicles will be able to determine their position, speed, and direction and then successfully negotiate access to a virtual slot. Once a slot is assigned to the vehicle, the vehicle must not stray from the slot and thus speed and direction must be controlled. We don't expect vehicles to be able to fully and automatically 'drive' themselves in ten years – this will likely take longer to achieve. However, in ten years we expect vehicles to be able to suggest appropriate action to drivers such as reducing or increasing speed. For example, in lane junctions, two vehicles driving on different lanes will detect that their virtual slots will collide once their lanes have merged. The vehicles will negotiate their new slots on the outgoing lane (e.g. slightly offsetting the slots in opposite directions so they don't overlap) and inform their drivers that they should accelerate or break just enough to keep to the new slots.

Figure 2 illustrates this example. At time  $t_1$  the vehicle on the right lane (slot 2) needs to change lane. This vehicle would have a number of approaches to do so. 1) This vehicle breaks and waits for an opening on the left lane. The vehicle in slot 3 would not be affected, but this would cause the vehicle in slot 2 to be left behind its slot, to run into new slots that would potentially appear behind it, and to cause traffic congestion. 2) This vehicle keeps its speed and changes to the left lane, not keeping the safety distance to the vehicle in slot 3 behind it (fig. 2, option a, time  $t_1 + \Delta t$ ). This would likely cause the vehicle in slot 3 to do an

emergency break, potentially running into slot 4 and starting wave congestion. 3) This vehicle communicates with the vehicle in slot 3 to attempt to coordinate the lane change (fig. 2, option b, time  $t_1 + \Delta t$ ). As a result, the vehicle in slot 3 would slightly delay its slot (braking) and the vehicle in slot 2 would slightly advance its slot (accelerating) so that upon lane change the safety distance is maintained and the vehicles can keep to their new, offset slots. Note that offsetting these slots requires more than the coordination between vehicles in slots 2 and 3. In fact, the vehicle in slot 3 must coordinate with the vehicle in slot 4 so that slot 3 does not run into slot 4 as it temporarily lags behind. This approach would effectively prevent congestion as vehicles cooperate to keep to their slots.

## 2.3 Self-regulating flow control

In addition to controlling the speed and safety distance between vehicles using the virtual slot system, we must limit the rate of vehicles that enter a lane and make sure that the rate of vehicles that exits the lane is not inferior to the rate of entry. We envision a mechanism to control the inbound and outbound vehicle flows of a lane and prevent traffic congestion. This mechanism is two-fold.

Firstly, our cooperating vehicles must allocate a virtual slot in a lane before they enter that lane. Failure to allocate such a slot, namely in the case where the lane has reached the maximum inbound vehicle flow, will result in the vehicle not being allowed to enter the lane. Thus vehicles self-regulate the inbound flow of a lane by abstaining from entering the lane at peak conditions. Notice that virtual slot speed and length determine the maximum virtual slot rate. If the inbound traffic flow exceeds the maximum slot rate then the distance between vehicles diminishes. This forces drivers to maintain safety distances by reducing speed and, as such, causes congestion. In order to prevent such congestion, slot allocation fails in our envisioned system when inbound traffic flow is larger than maximum slot rate.

Secondly, outbound flow must not be inferior to inbound flow if congestion is to be avoided. We try to better understand outbound flow by considering what happens to vehicles when they leave a lane. Outbound vehicles will either enter another lane or stop at a parking space. Eventually however, every vehicle will finish its journey at a parking space. Difficulty in finding parking space will diminish the outbound flow of parking vehicles and potentially lead to congestion. In our vision, the urban landscape is full of different sensing and cooperating objects. In particular, drivers will rely on these objects to find available parking space. These objects can be, for example, wireless sensor networks deployed on sidewalks and that can detect the presence of vehicles on nearby parking spaces. Moreover, these objects can cooperate with vehicles that need to park by making parking space reservations and preventing other vehicles to park in places that have already been reserved. For an end-to-end approach to traffic congestion, vehicles have to allocate their destination parking space before they start their journeys – thus self-regulating outbound as well as inbound flows.

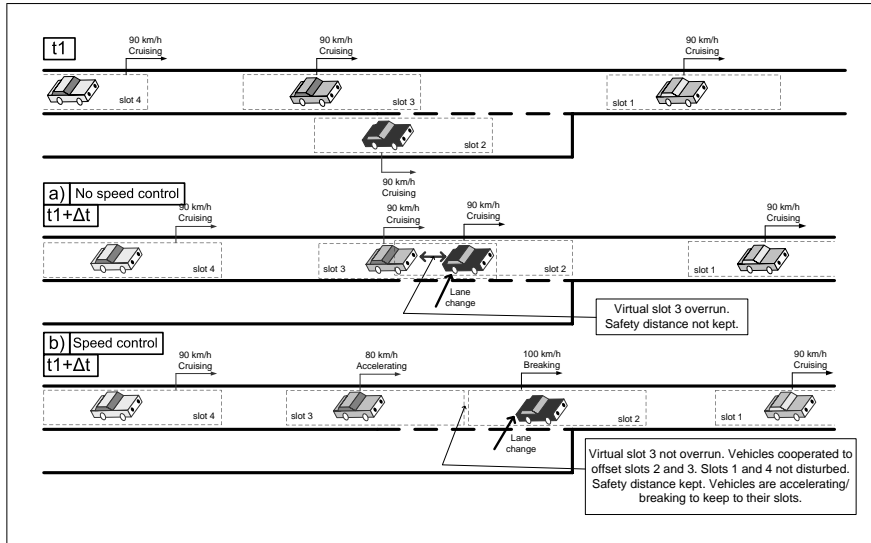

Figure 2: Example of merging lanes a) without and b) with vehicle cooperation.

### 3. SUPPORTING SIMULATIONS

We have used a third-party open source road traffic simulator to test the concepts of our vision, namely the virtual vehicle slot. The third-party simulator source code and papers on traffic simulation in general and on wave phenomena in particular can be found at [4]. Figure 3 shows congestion on a typical lane junction. Notice how vehicles have to stop and queue to change to the main lane. When a vehicle with a slow speed changes to the main lane, it will cause the vehicles behind it on the main lane to reduce their speed to prevent them from colliding with the slow vehicle ahead of them. This causes congestion and in particular the wave phenomenon that can be noticed on the curve of the main lane. Compare this with fig. 4 in which vehicles coordinate lane change with the vehicles on the main road. Notice in particular that 1) the inbound flow on both lanes and the simulation time are the same as those on fig. 3 and that 2) no wave phenomenon or congestion in general occurs in fig. 4 as vehicles coordinate lane change with the vehicles on the main lane.

### 4. RELATED WORK

Our review of related work on using cooperating vehicles for preventing traffic congestion identified two separate research efforts.

Firstly, we have identified research whose main focus is on road traffic per se. For example, the U.S. Intelligent Transportation Systems (ITS) program [3] has proposed new initiatives such as integrated corridor management systems, cooperative intersection avoidance systems, and vehicle infrastructure integration. Another example is the Japanese ITS program that focuses e.g. on vehicle information and communication systems (VICS) [2] and on advanced cruise-assist highway systems (AHR) [1]. These programs build on road network planning, on vehicle sensing, and on vehicle-to-road communication to prevent congestion and avoid collisions. Cooperation between vehicles is only used to support collision avoidance and not to prevent congestion as in our

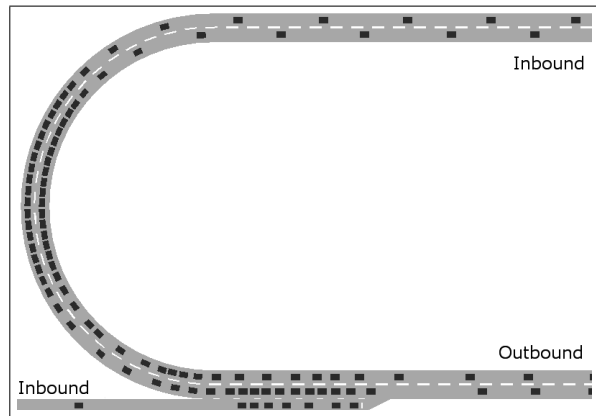
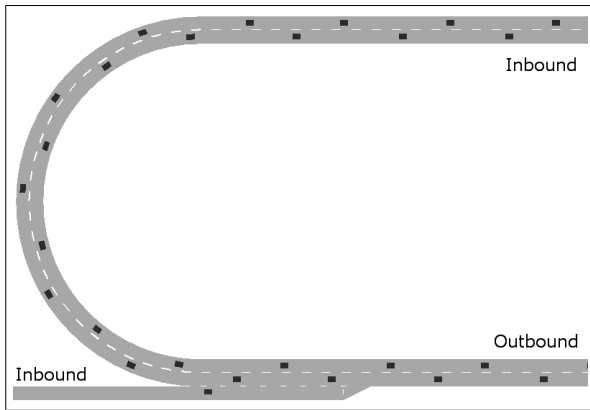

Figure 3: Typical scenario provided in the original simulator source code. Notice the congestion.

envisioned solution.

Secondly, we have identified research whose main focus is on communications, sensing, and software for cooperating vehicles. For example, research at Lancaster University [6] has yielded an autonomous vehicle capable of cooperative behaviour without human control and of autonomous navigation. Another example is the ITS work by NEC [5] that focuses on e.g. congestion monitoring using sensor information from vehicles (termed Probe Information System) and vehicle-to-vehicle communication for transmitting traffic congestion events. Although these contributions build on the technology for cooperating vehicles, they are not intended to prevent congestion in advance (i.e. before congestion occurs) as our envisioned solution is.

In conclusion, although research on intelligent transportation systems has focused e.g. on traffic network planning,



**Figure 4:** Exactly the same scenario as in fig. 3 except that the simulator was modified to support vehicles coordinating lane change with the vehicles on the main lane. (Notice the absence of congestion.)

on automated vehicle collision avoidance based on proximity sensors and vehicle cooperation, on traffic network congestion monitoring, on vehicle-to-vehicle wireless communication, and on autonomous vehicle navigation, to our knowledge there is no related work or publicly available vision on vehicle cooperation for preventing traffic congestion and in particular on preventing such congestion with the help of dynamic time-space corridors.

## 5. SUMMARY

We have described our vision of congestion-free road traffic using cooperating objects. In particular, cooperating vehicles are able to negotiate virtual vehicle slots needed for the whole of their passengers journey, i.e. from departure to arrival. These slots have guaranteed speed and safety distances to other slots and as such will not be overrun by other vehicles. Vehicles in these slots will not experience traffic congestion. Our vision includes the negotiation of the virtual slots at the consecutive lanes through which the vehicle needs to circulate and of parking space for the end of its journey. Cooperating vehicle and urban landscape objects provide support for such negotiation and thus enable our vision of congestion-free road traffic.

To the best of our knowledge, the concept of time-space corridors for vehicles is original. This concept was inspired by research on data communications protocols. Furthermore, we have described an innovative use of cooperating and sensing vehicles as we expect these to negotiate and establish congestion-free virtual slots. We expect that the implementation of this congestion-avoiding system will bring forward new challenges and technical progress. We also expect the social, economical, and environmental impact of deploying our envisioned system to be tremendous. Environmentally, we expect that without traffic congestion there will be less pollution on the roads. Economically and socially, we expect that people will spend less time commuting and in general be less stressed and more productive. Finally, we expect the deployment of our envisioned system to become a source of

technical and economical development for the vehicle and telecom industry.

## 6. ACKNOWLEDGEMENTS

The author would like to thank the Sentient Future Competition for awarding this paper.

## 7. REFERENCES

- [1] Japanese ITS AHR web site. <http://www.ahsra.or.jp/>, 2006.
- [2] Japanese ITS VICS web site. <http://www.its.go.jp/etcvics/vics/>, 2006.
- [3] US ITS New Initiatives' web site. <http://www.its.dot.gov/>, 2006.
- [4] Web site of the road traffic simulator used in this paper. <http://www.helbing.org/>, 2006.
- [5] M. Maekawa. ITS (Intelligent Transportation Systems) Solutions. *NEC Journal of Advanced Technology*, 2004.
- [6] T. Sivaharan, G. Blair, A. Friday, M. Wu, H. Duran-Limon, P. Okanda, and C.-F. Sorensen. Cooperating sentient vehicles for next generation automobiles. *First International Workshop on Applications of Mobile Embedded Systems*, June 2004.





**Sentient Future Competition: Highly Commended  
Entries**

# Sentient Future Competition: Ambient Intelligence by Collaborative Eye Tracking

Eiko Yoneki  
University of Cambridge  
Computer Laboratory  
Cambridge CB3 0FD, UK  
eiko.yoneki@cl.cam.ac.uk

## ABSTRACT

A key aspect for the design of a future sentient computing application is providing ambient intelligence for non-expert users. Automatic, self-organizing and self-managing systems will be essential for such ubiquitous environments, where billions of computers are embedded in everyday life. Eye tracking provides information on both explicit and implicit subconscious social interactions and indicates directions when other communication is inappropriate. Integration of eye tracking and sentient technology will create a powerful paradigm to control and navigate applications. In a public setting, the aggregation of people's observations and knowledge provides a valuable asset. Ten years progress on sensor device hardware and software should realize this paradigm, and numerous applications can be integrated into this technology.

## 1. INTRODUCTION

We witness a rapid evolution in wireless devices and ubiquitous computing (aka ambient computing), with small computers becoming embedded throughout our environment. Wireless Sensor Networks (WSNs) are composed of multiple, interconnected nodes that are equipped with sensors, wireless communication transceivers, power supply units, and microcontrollers on chips of only a few millimeters square. The sensors are used to gather different types of data such as pictures, motion, sound, temperature, radioactivity, and pressure. In ten years, we imagine that more advanced sensors will appear and those sensors are able to capture 3D images from far distances with high accuracy. Sensors interconnect to establish multi-hop wireless networks streaming captured multimedia data. This heterogeneous collection of devices will interact with sensors and actuators embedded in our homes, offices and transportation systems, all of which will form an intelligent pervasive environment. People have to interact with invisible, ambient technology, which must be usable by non-experts. Thanks to Ambient Intelligence, the system will need less input from users and fewer mistakes will occur, because it will take note of the user's history and context and can make 'educated' guesses of the user's needs. Thus, the system will come up with suggestions and questions like 'I think you will need this', or 'Would you like me to adapt for this context?'

The vision of an activated world is action oriented, and, rather than dictated, it follows and enhances human behavior. The social implications are substantial. For example, is the person looking directly at you, to the ground or simply past you, showing interest or boredom, aggressiveness or submissiveness [14]? These habits form a powerful method of subtle communication. This new

dimension of ubiquitous computing requires more complex communication mechanisms and, most importantly, intelligent processing of information collected from sensors. Network environments for ubiquitous computing will be highly decentralized, distributed over a multitude of different devices that can be dynamically networked and will interact in an event-driven mode.

This paper describes future ambient computing, where sentient applications are controlled and coordinated by human eye tracking in many different ways such as forming group communication, sequence of interactions, consensus of the next action, and so forth. Coordination of eye tracking can be between two people, between a person and an object, or among several people. Research requires extensive work with interactive robotics, computer vision, image recognition-understanding-generation, machine learning, data mining, as well as human behavioral studies and cognitive modeling. Ten years will give ample progress in these areas.

Eye (Gaze) tracking is an important human social skill. It is believed that the form of the human eye has evolved in such a way as to allow other humans to infer the direction of other people's view with ease [6]. Especially the high contrast between the sclera (the white part of the eye) and the iris is unusual and cannot be seen in this form in other species [9]. Eye tracking is used in explicit and implicit subconscious social interactions as well as to point and indicate directions when vocal communication is inappropriate. People can immediately recognize if their communication partner is looking at them or past them and infer characteristics of the partner such as interest, fear, or unease from it. Sensitive eye movements can act as a language of emotional states and therefore their detectability in visible light was an important gain in evolution. There are also numerous application fields of eye tracking and they can be grouped into two main tasks, point of interest detection and information transmission via eye movement, although spanning across these fields is common.

Determining attention focus is probably the most common use, although attention is not directly coupled with the line of sight. Point of interest information can be used in a multitude of applications of which marketing, psychophysical experiments, and verification of attention to critical situations such as traffic while driving [18] are the most common uses.

The second main area is to use movement as a direct channel of information, encoding bits as eye movement to the left or to the right. As this method has a relatively low bit rate, it is most often used if other methods of communication are no longer available. This case usually arises from medical conditions when patients

have no voluntary control over large parts of their muscles, such as after penalization or with Amyotrophic Lateral Sclerosis (ALS) [2]. ALS for example is a degenerative neural disease causing total loss of muscle control, but sometimes before the terminal stage of locked-in syndrome, eye movement is still possible. For these people, a technical solution for communication via eye tracking can mean at least a little normality in an otherwise difficult situation [5, 11].

Applications combining these two are becoming increasingly popular, as they use point of interest detection as a way of controlling systems. This finer scale resolution allows for a higher bit rate and makes such systems susceptible to more advanced Human Computer Interaction (HCI) devices. For example, the military has used helmet-based eye tracking to act as an additional input and free the pilots' hands to perform other duties. Civilian applications of gaze-based HCIs exist as well, for example for video conferencing or civilian avionics. Furthermore, technical applications of gaze tracking would be necessary in artificial intelligence and social robotics. To mimic human behavior, a robot would have to be capable of reading the emotional language encoded in the movement of the eyes and the direction of gaze.

A significant amount of research literature exists on eye tracking, but most of the earlier approaches have required special hardware and have been to some extent invasive [1, 16, 10]. Those limitations have prevented widespread use of gaze tracking and the technique is currently only used in specialist areas. I envision that the evolution of wireless sensor hardware will overcome many limitations. Sensors will be able to capture 3D images from a distance.

This paper continues as follows: Section 2 describes key aspects of technologies supporting sentient applications using eye tracking. Section 3 describes examples of application scenarios demonstrating the idea and Section 4 contains conclusions.

## 2. TECHNOLOGY

Research in ubiquitous computing covers diverse research areas, including distributed system design, distributed robotics, wireless communication, signal processing, information theory, P2P networking, embedded systems, data mining, language technology, intelligent agents, and optical technologies. Capturing the eye movement by cameras is possible with current technology, and advanced sensors for this purpose will appear within ten years. The challenge is to capture them from a distant sensor location and establish efficient real-time operation of wireless sensor networks. Outdoors, aerial robots can be used to collect such data. We have the essential technology already and what is needed is to make it scalable, reliable and deployable.

### 2.1 Eye Tracking

The first eye tracking method was proposed in 1969 for visual targeting of weapon systems by aircraft pilots, allowing them to keep their hands free to control the plane [12]. The first device was built by the US military [13]. These devices exploit that a person's direction of gaze is directly related to the relative positions of the centre of their pupil. The accuracy of these systems depends largely on how precisely the relative positions of the pupil centre and the corneal reflection can be located. To locate the pupil accurately, early systems used a light source at the side of the user and camera with a semi-silvered mirror mounted at 45 degrees to reflect light from the source along the camera axis

and into the eye of the operator. In 1989, an eye tracking device [7] was proposed which used a tiny infrared LED mounted in the center of an infra-red sensitive camera, eliminating the need for semi-silvered mirrors. In the more recent vision-based system, the tracking is performed by algorithmically analyzing images coming from video cameras. The use of IR LEDs and a camera conferred the additional benefit of a lighting independent image. The most recent development is to use a purely vision-based approach. These systems use the natural illumination of the scene and record images with normal video cameras to infer gaze direction. The most popular algorithms have been neural networks to learn the mapping of small images of the eye to the 2D gaze direction. One of the first groups was Baluja et al. [3] at CMU in 1994. The work was continued by Stiefelhage and Waibe [20] and achieved a high accuracy of about 1.4–2.0 degrees using a standard back propagation algorithm on images of size 20 x 10. More recently, other labs have developed similar methods, Xu et al. [23], and application fields are expanding, such as attention tracking during meetings [19].

### 2.2 Progress of Sensor Hardware

Current research envisages a multitude of inexpensive cameras and projectors embedded in the environment. The cameras infer the geometry and reflective properties of the visible surfaces and the projectors create 3D imagery for a user whose eye positions are tracked in 3D. Current limitations include sensitivity of the camera and narrow fields of camera view, and only few people can be tracked. The cost of cameras and eye contact sensors will fall in ten years, and more sophisticated sensors with eye tracking capability will appear for highly detailed observation of eyes.

### 2.3 Ubiquitous Computing

The Internet and computer hardware/software made large scale distributed computing possible. The evolution of ubiquitous computing will make a change in a different dimension. Individual systems have to scale down to support ubiquity. Data from sensor networks need to provide pervasive access through a variety of wireless networks. There are inherent resource limitations in the technologies for processing, storage and communications (and power) in this context, and these lead to novel system performance requirements. A new platform needs to cover the range from tiny MEMS to Internet scale P2P systems and must include not only quantitative performance but also quality of service as a critical issue. A total system view will be based on information from a variety of heterogeneous sources and will require knowledge fusion; a reactive system between sensing, decision making and acting will be a common application feature. The architecture of global computing is a fine-grained, open, component-based structure that is highly configurable and self-adaptive. A difficult issue here is that current applications are tied to sensor deployments (see [22] for more details). A new type of open platform is required, where sensed data can be shared among different applications over large-scale environments. Data management over heterogeneous networks, computing, and social environments will be crucial.

Ubiquitous computing infrastructures require software technologies that enable ad hoc assemblies of devices to spontaneously form a coherent group of cooperating components. This is a challenge if the individual components are

heterogeneous and have to engage in complex activity sequences to achieve a goal. Today, the interaction between the components of these environments is carefully designed by hand. Most sensor network applications are implemented as complex, low level programs that specify the behavior of individual sensor nodes. WSNs need to organize themselves from components built by different applications. Programming for WSNs raises two main issues; programming abstractions and programming support. The former focuses on providing programmers with abstractions of sensors and sensor data. The latter is providing additional runtime mechanisms that simplify program execution.

**Context Awareness:** Next-generation conference rooms are often designed to anticipate the new rich media presentation. Current research in high-end room systems often features a multiplicity of thin, bright display screens (both large and small), along with interactive whiteboards, robotic cameras, and smart remote conferencing systems. Smart spaces and interactive furniture design projects have shown systems embedded in tables, podiums, walls, chairs and even floors and lighting. Exploiting the capabilities of all these technologies in one room, however, is a daunting task. For example, faced with three or more display screens, all but a few presenters are likely to choose simply replicating the same image on all of them. Even more difficulty is the design challenge: how to choose which capabilities are vital to particular tasks, or for a particular room, or are well suited to a particular culture. The incorporation of media-rich engagement strategies in meetings creates a need to provide meeting participants with appropriate tools for managing these media. Research in areas such as context-aware computing, interactive furniture, and mobile devices is moving rapidly. People expect to find the adaptable ease of use that they get from their personal devices in all the technology they encounter.

## 2.4 Security

Wireless networks are becoming more pervasive and devices more programmable, thereby facilitating malicious and selfish behavior. A ubiquitous application may involve collaboration between ad hoc groups of members. New encounters occur and there are complex issues in knowing what entities to trust. Based on predefined trust, recommendations, risk evaluation and experience from past interactions, an entity may derive new trust metrics to use as the basis for authorization policies for access control (see SECURE project [4]). This raises serious concerns about privacy, surveillance and freedom of action. While providing location information can be a one-way system where the location providing tools do not track who is receiving, once your phone, PDA, or other device receive information, your location is potentially available to others. The design of the system will require multi-disciplinary efforts by technologists, social scientists, and societal observers.

## 3. APPLICATION SCENARIOS

There will be many different uses of the approach described in the previous sections. Several potential scenarios are described below. This list is not exhausted.

### 3.1 Intruder Detection

By using the correlation between gaze-direction and point of interest, it is possible to find an unobtrusive way of determining attention. This allows gathering the data while people continue their normal task unaware of monitoring, providing data of

conscious and subconscious awareness in a natural environment. At an airport, for example, the sensors on the wall sense people's gaze movement. People notice any strange incident, other people's behavior, or objects unconsciously for  $\sim 0.000001$  seconds. This information can be collected to use the detection of any security violation such as suspicious behavior of people or objects left alone.

### 3.2 Screen Navigation

The multiplicity of recent displays makes it difficult to control what should be shown on specific featured displays. This can be controlled through an eye tracking orchestrated interface. An eye tracking mechanism calculates the user's gaze direction and this can be used to control the volume of the soundtracks of the video streams either by increasing the volume of the selected stream, scaling the volumes by their spatial distance from the selected stream, or scaling the volumes by their temporal distance from the selected stream so the less recently selected streams are quieter. Gaze direction can also be used to identify the stream at which the user is looking and zoom in on it, following a time-out period. The centre of the user's attention can be drawn in higher detail than the rest of the picture by eye tracking in non-uniform rendering of images.

- You are at an airport lounge waiting for the gate assignment of the plane. When the plane delays, the rescheduled time could be in 10 minutes or in 1 hour. The flight schedule screen senses gazes, and when it gets high hits, it releases additional information on the screen or delivers information to the customer's mobile phone. Eyes are used to communicate with the tag on the screen.
- At the main plaza during a nice summer evening, people are watching a football game on a big screen. The screen zooming or selecting the angle are chosen based on the gaze movement of the audience. What is on the screen will thus reflect the interest of the majority of people.
- Interactive TV: sensors are embedded in the TV, which senses movement of gaze for navigation such as zooming or changing channels.

Rennison et al. [17] have worked on gestural navigation of multidimensional information space in 1995 at MIT Media lab. Figure 1 shows 3D Internet browsing navigated by hand gestures. The evolution of sensor networks since 1995 indicates that the next ten years will bring further dramatic progress in technology.

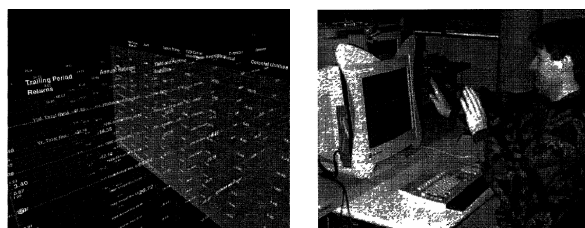

Figure 1: 3D Internet navigation by hand gesture (from [17])

### 3.3 Effective Video Conference

Video conferencing is a useful tool to conduct meetings without travel. One potential problem is that video conferencing does not necessarily support the regulation of conversational turn taking

any better than telephony-based systems. In multiparty conversations, when the current speaker falls silent, it is not obvious who will be the next speaker. Previous research suggests that the looking behavior of conversational partners, or more specifically, their eye contact with each other, plays a critical role in determining who is to be the next speaker in group conversations [8, 21]. Using low cost eye tracking and measuring eye contacts among the participants could accurately provide more natural video conferencing. There has been an approach to solve this problem by setting multiple cameras, but using 3D image sensors with networking capability will make this even simpler and more effective.

### 3.4 Medical Applications

There are some medical conditions such as paraplegia, that make other, more traditional methods of communication increasingly difficult, or even impossible. For these patients, eye tracking devices could be a method of communication and improve their quality of life.

Another example is for patients with psychologically complex problems where logging eye tracking data for certain periods could help to find hidden mental problems.

### 3.5 Unsafe Driving Detection

Eye tracking by sensors detects unawareness of traffic conditions by the driver and offers the potential of improving safety by alerting the driver of tedious but potentially dangerous situations if not sufficient attention is given to the traffic.

### 3.6 Shop Assistance

Customers' gaze movements are captured to determine which colors of clothes their eyes are on, which types of DVD recorders their eyes are on, and how long their eyes are kept on those objects. The shop could assist the customers by showing more products of interest based on these observations. Furthermore, this information could be used for future improvement of the products or layout of the shop display.

## 4. CONCLUSIONS

Automatic, self-organizing and self-managing systems will be essential for supporting ubiquitous environments, where billions of computers are embedded in everyday life. A key aspect to design a future sentient computing application is to provide ambient intelligence for non-expert users. Eye tracking provides explicit and implicit subconscious social interactions and indicates directions when other communication is inappropriate. Integration of eye tracking with sentient technology will create a new paradigm to control and navigate applications. In our society, there is information overload while people are not getting the information they need. They might not even know what exactly they want or need. In a public setting, the aggregation of people's observations and knowledge is a useful and important asset, which can be harvested without the conscious contribution of anybody. Using ambient intelligence, a consensus of knowledge can be obtained and used for good purpose without interfering with people. The applications proposed in this paper aim to construct ambient intelligence by eye tracking, providing ways of effectively coordinating humans, objects, and environments in invisible ways by sentient objects.

**Acknowledgement:** This research is funded by EPSRC (Engineering and Physical Sciences Research Council) under grant GR/557303. I thank Earl Rennison for showing his work (in 1995) and inspiring the proposed ideas and Jean Bacon (University of Cambridge) for providing helpful suggestions on wireless sensor networks.

## 5. REFERENCES

- [1] A. S. Laboratories. <http://www.a-s-l.com>.
- [2] Amyotrophic lateral sclerosis fact sheet. [http://www.ninds.nih.gov/health\\_and\\_medical/pubs/als.htm](http://www.ninds.nih.gov/health_and_medical/pubs/als.htm)
- [3] Baluja, S et al. *Non-intrusive gaze tracking using artificial neural networks*, Technical Report CMU-CS-94-102, Computer Science Department, USA, 1994.
- [4] Cahill, V. et al. *Using trust for secure collaboration in uncertain environments*, IEEE Pervasive Computing, 2(3): 52-61, 2003.
- [5] Chapman, J.E. *Use of an eye-operated computer system in locked-in syndrome*, CSUN's International Conference: Technology and Persons with Disabilities, 1991.
- [6] Emery, N. J. *The eyes have it: the neuroethology, function and evolution of social gaze*, Neuroscience and Biobehavioral Reviews, 2000.
- [7] Hutchnson, T.E. *Eye Movement Detector*, U.S. Patent 4,836,670, 1989.
- [8] Isaacs, E. et al. *What Video Can and Can't Do for Collaboration*, Proc. ACM Multimedia, 1993.
- [9] Kobayashi, H. et al. *Unique morphology of the human eye*, Nature, 1997.
- [10] L. Technologies. <http://www.eyegaze.com>.
- [11] Majaranta, P. et al. *Twenty years of eye typing: systems and design issues*, Proc. ETRA, 2002.
- [12] Mason, K. A. *Control Apparatus Sensitive to Eye Movement*, U.S. Patent 3,462,604, 1969.
- [13] Merchant, J. et al. *A Remote Oculometer Permitting Head Movement*, Aerospace Medical Research Laboratory, WrightPatterson Air Force Base, AMRL-TR-73-69, 1973.
- [14] Nummenmaa, T. *The language of the Face*. University of Jyväskylä Studies in Education, Psychology and Social Research, 1964.
- [15] Ramesh Raskar, G. et al. *The Office of the Future: A Unified Approach to Image-Based Modeling and Spatially Immersive Displays*, Proc. SIGGRAPH, 1998.
- [16] S. Instruments. <http://www.smi.de>.
- [17] Rennison, E. et al. *Issues of Gestural Navigation in Abstract Information Spaces*, ACM CHI Conference, 1995.
- [18] Smith, M. et al. *Determining driver visual attention with one camera*, IEEE Transaction on Intelligent Transportation Systems, 2003.
- [19] Stiefelhagen, R. *Tracking and Modeling Focus of Attention in Meetings*, PhD thesis, University of Karlsruhe, 2002.
- [20] Stiefelhagen, R. et al. *Tracking eyes and monitoring eye gaze*, Proc. Workshop on Perceptual User Interfaces, 1997.
- [21] Vertegaal, R. et al. *Effects of Gaze on Multiparty Mediated Communication*, Proc. Of Graphics Interface, 2000.
- [22] Yoneki, E. and Bacon, J. *A Survey of Wireless Sensor Network Technologies: Research Trends and Middleware's Role*, Technical Report UCAM-CL-TR646, University of Cambridge, 2005.
- [23] Xu, L.-Q. et al. *A novel approach to real-time non-intrusive gaze finding*, British Machine Vision Conf., 1998.

# Sentient Future Competition

## “A day in the life of a not too distant future”

Phillip R De Caux  
xposition  
Hollyhock Cottage, Buttle Lane,  
Shepton Beauchamp, Somerset, UK  
+44 1460 249396  
phildecaux@xposition.co.uk

### ABSTRACT

In this paper, I try to envisage how the development and proliferation of embedded systems will affect normal daily life in 10 years or so.

### 1. INTRODUCTION

Presented as an advertising feature, my vision illustrates some of the many advantages of an integrated life-work information and communication tool, the eLink™ (WiSIP/MAN) headset. The eLink™ operates efficiently and seamlessly within a wireless LAN/MAN environment and is fully compatible with complimentary systems such as route planning, home/small office automation, traffic control, transport routes and booking, financial transactions, and personal space protection.

The eLink™ headset uses the latest onboard encryption and Session Initiation Protocol (SIP) technology to provide a secure and robust performance which, coupled with a long-life rechargeable battery, amazing light weight and comfortable design, will complement and enhance daily life beyond what is imaginable using today's systems!

### 2. A DAY IN THE LIFE OF A NOT TOO DISTANT FUTURE

Hobz woke to the sound of a subdued, yet irresistible polyphonic cacophony. As his feet touched the carpet, the alarm clock, sensing his movement, curtailed its insistent racket and the radio came on to announce that yet more atrocities had been carried out in the name of world security.

His clothes lay in the same abandoned heap they had been left in the night before, and he cursed himself for not being more careful - now he would either have to wear a crumpled suit or, worse still, would have to wear the awful one that rarely made an entrance into the office. Now that he worked mainly from home, his suit collection had depleted somewhat.

Then he remembered that he had forgotten to 'phone Olivia - again! It hadn't helped that he had left his eLink™ off the base unit the night before and couldn't access his address book. It was only when he got home that the system had updated and recharged itself. Even though it was almost a valid excuse, when he tried contacting her the network could not find her. She was either out of range, or, more likely, he had been added to her "blacklist".

After showering, he selected the best of the bad suit options and got dressed. He then detached the fully-charged eLink™ from its

base unit on his bedside cabinet and wound it around his ear. Immediately, he was informed there was a problem in the kitchen.

As he walked in, rather than the familiar scene of a prepared breakfast, instead the table was decidedly empty and an urgent bleeping was emanating from the info screen on his refrigerator. He had forgotten to approve the shopping order and so, to use a phrase his mother was fond of, the cupboard was bare. Perhaps he should set the system to "auto-order"; this was getting to be a habit!

### Direction and deviation

Yet another pre-office visit to the extortionate breakfast bar beckoned! He added the detour into the autoSOHO™ and selected some food and drink from the menu that appeared on the screen. The eLink™ issued a comforting bleep to indicate that the route details had been transferred and, pausing only to pick up his rucksack, he left the flat. The door beeped at him a couple of times and then the eLink™ let him know that the flat was secure. Hobz remembered when he used to rush around at the last minute trying to find his keys, invariably making him late and stressed - how times have changed!

En route, Hobz spoke the phrase "Harry - office" and the eLink™ responded with a connecting tone and, a few seconds later, Harry answered. Hobz let him know that he might be a bit late and got the low-down about the first meeting of the day. He could have made the journey with his eyes closed, the quiet voice in his ear telling him which direction to take, when to wait at a crossing and when to cross. Any potential collision with a fellow pedestrian or lamp post was pre-empted by a gentle warning from the optional Personal Space Protection System (PS2)™.

### Expectation and transaction

He entered Penn's Coffee Bar and sat at a vacant stool at the bar. Within seconds, the assistant brought over his order, a bacon sandwich drowning in chili sauce with a huge, steaming cup of "builder's tea". Hobz thanked her profusely and started eating the delicious and, more than likely, toxic sandwich. Though incredibly bad for the majority of his organs, this was an excellent hangover cure! Once he had finished, the eLink™ prompted him to approve the bill. He pressed his index finger on the pad and, his identity confirmed, the payment was deducted from his account.

Though incredibly bad for the majority of his organs, this was an excellent hangover cure! Once he had finished, the eLink™

prompted him to approve the bill. He pressed his index finger on the pad and, his identity confirmed, the payment was deducted from his account.

### Safety and speed

Fifteen minutes later, completely refreshed, Hobz turned left, as suggested, into Broad Street and joined the crowd of people waiting to cross the road at the crossing point. He waited no more than ten than ten seconds before the vehicles halted automatically to allow the mass to surge forward. He still found this disconcerting, but apparently accidents at crossings had been reduced by some amazing percentage.

A group of people, Hobz included, parted from the main pack and headed towards the underground. He walked through the e-stile, the voice in his ear informing him he had been charged five pounds for the privilege, and descended the escalator to the platforms below. Whilst directing him along the correct path to his platform, the voice informed him that the next train was due in two minutes and suggested he walk a little faster ...

### 3. ACKNOWLEDGMENTS

My thanks go to the tutors and students at Liverpool University and Laureate Online Education for inspiring me to write this paper and for helping me find the skills to be able to think about the future with a fresh outlook.

<b>SPECIFICATION</b>	<b>Manufacturer/supplier</b>	Deutsche Telekom
	<b>Model</b>	eLink10™ (MAN <sup>1</sup> WiSIP <sup>2</sup> ) headset
	<b>Fitting</b>	Ear hook design (left or right fitting)
	<b>Weight</b>	10g
	<b>Headphone</b>	Monaural, 18mW@16Ω (max)
	<b>Microphone</b>	Miniature omni-directional electret condenser
	<b>User controls</b>	Voice recognition, pressure sensitive pad
	<b>Security</b>	Access via pFPM™ – partial fingerprint matching via built in pressure pad WEP/WPA + AES encryption
	<b>Power</b>	Integrated/rechargeable Li-Poly battery Power management system offers up to 100 hours on standby and 4.5 hours continuous use
	<b>Standard services</b>	Wireless/mobile telecommunications (SIP) Metropolitan Navigation overlaying Satellite Navigation (ManNav over Sat-Nav)
	<b>Standard additional equipment</b>	eLink docking station including recharging unit and LAN
<b>Optional services/equipment</b>	Personal Space Protection System (PS <sup>2</sup> )™ eTransact™ interface, autoSOHO™ interface, RSSAnnounce™, tLink™ interface, recharging unit	

*Please note that any trademarks are for effect only and are not designed to imply any actual legal standing*

**Figure 1: Possible specification for the eLink10 system**



# Sentient Future Competition: Embedded WiSeNts & Agnostic Algorithms of Creation

Panagiotis Bairaktaris  
Bsc Student in Computer Science,  
City University, London, UK  
42, Abbott's Park Road  
E10 6HX Leyton, London  
++44 (0) 7913 1712245  
panos95@yahoo.com

## ABSTRACT

...explore the possibilities of interference among two distinct but almost identical dimensions by letting things that happening in the virtual world to reflect themselves in reality....

## 1. INTRODUCTION

It is a lazy Sunday afternoon after a long Saturday night... and here I am, sitting on a bench in Hyde Park. '...a quiet evening... after a crazy party night is well deserved...' were my thoughts whilst looking at the people rollerblading around the lake. Suddenly I hear my mobile's ringing; it is Dennis, my friend from the University. I was wondering how he was doing – a little hungover maybe?

-Hey mate, how are you? Are you all right?

-Yeah man, I'm fine, I was just checking out our new assignment '*Parallel Environments within Divine and Agnostic Algorithms of Creation...*' I thought I should call you 'cause ... man- it really doesn't make any sense...

-Hmm...well, emm...maybe not now...I'm about to lay flat on the grass in Hyde Park, enjoying the sunshine...

-Hey, don't feel pressured – but we have to do it by the end of next week – so you might want to have a look at this and then talk about it. C'mon, you don't have to leave the park – you know that...

-Alright – just a moment...

## 2. WHAT IS ALL ABOUT?

### 2.1 Mobile reality

I plugged into my mobile the new pair of sunglasses I bought the summer I was in Greece. No fancy stuff – just a nice pair, good enough for the morning after party – not to mention you don't look stupid when you're 'out there' – in your mobile's cyberspace.

The afternoon sunshine got a bit blurred and darkened, and then gave its place to a rapidly progressive appearance of a 3D environment. The sound of the people around me got mixed with some electronic interference from the small headphones embedded in my sunglasses. The lenses from outside were

looking like normal lenses – sub-mirroring the environment- but there was always an option to project a message like '*don't bother me please*' or '*I 'm not here but I still can see you*'. Not my liking though – especially when cyber-communicating in a public place. Too much information – don't want to.

But the best thing about these sunglasses is that you don't have to worry about energy – no batteries needed – but that's because they are sunglasses, if you know what I mean!

Dennis was sitting in his armchair in front of the computer, as I was appearing in his cyber-room – an identical representation of his actual room, in Muswell Hill.

The environment resolution was absolutely faultless – no flickering or distorted angles. Mobile graphic cards have been evolved since I got my first mobile with a coloured screen– almost 10 years ago. He was looking like he'd just woken up – which he had. I was looking exactly like how I left from home this morning – last time I looked at myself in the mirror just before I went out of house.

### 2.2 Recently updated by mirror

The mirror in my house is one of the latest models. Too many settings – although it can do lots of things – if you want or need them of course. Every time you look at yourself in this mirror the databank in the central house computer is updated with the current image of yours – describing how you look and what you wore – and not only that: Through the mirror you can see past states of yours, i.e. how you were looking yesterday or last week, or even fiction ones, i.e. with this or that kind of t-shirt, jacket.

Our university project is the replication of our everyday life, created and modelled in a computer system in the form of a video game– the aim is to explore variations of '*decisions that have been already taken and actions that have already been done*' – that means that my everyday mirror image is well being used. Of course in the cyber mobile space you could appear as you like – but people tend to use this option only when they are participating in cyber communities. In normal everyday life, when there is a need for mobile 3D contact – from people who are using the technology for working, or studying, or meeting up with someone who is far away – they prefer to act like themselves. In police stations and the cyber-courtroom for instance, this is required by

law; you can't enter the virtual room if you're not who you're supposed to be.

By the time I appeared to Dennis's room, he was typing something on the computer. He was actually doing this on real time in his place – what I was seeing was the result of his key-tapping actions as they were captured by his keyboard – and then processed in a way to reproduce the actual move of his hands on the keypad. The combination of the data that his computer was receiving from the Internet plus the on-time calculation of the moving 3D model of himself plus the representation of his room on the house central database, all these were being transmitted through his mobile, routed through one of the many wireless broadband network nodes around the city, and finally finding their way up to my mobile handset. In the same time, my holographic –recently updated by mirror- picture of me was sent back to Dennis's virtual mobile reality -equipped with the latest human-body modelling movement application- which was enhanced for both me and Dennis with the data that our clothes were producing in real-time according to our movements. The speech, image and body movement synchronisation is amazing – due to the high-detailed and powerful multi-dimensional graphics libraries that are available nowadays for free – so every virtual mobile can download and use.

## 2.2 Where everything comes from

All this were able to be realised by a combination of *Embedded WiSeNts*, a widespread mini-electronic computer technology that enables 'Cooperating Embedded Systems for Exploration and Control featuring Wireless Sensor Networks'.

These super-nano microchips are almost everywhere, in every kind of hi-tech or house equipment, in every pack of consumable product, in every clothing brand, even in things like the litter tray of a cat or the rubbish bin. They have changed drastically all aspects of life – even when machines are not involved, like relationships and beliefs.

First it was simple things like automated switch-controllers or small product-information data containers - they could be read with appropriate equipment but rapidly they evolved and acted wirelessly, transmitting data of the state of the object, most of the times using power sources such as heat or movement. Functions and information of things like the house-hold equipment, alarms, hi-fi, lights and heating are already easily accessible wireless from your mobile where ever you are – when ever you want. It's been quite a long time since you worried about leaving the light on, or the tap is leaking and you're on the beach in the Seychelles. Every new house is required to have a central network infrastructure which can be controlled externally by your computer and your mobile if you like – and these little things can interconnect with it. You can't get a building license otherwise. New ethical and operational issues rose by this – who has the password, who is the admin of the house, (me or my girlfriend?), and what if more than one person has main access to control things from far? And what about if my mobile is stolen? Does this mean that a complete stranger can have fun by changing the TV channels whilst I'm watching my favorite show?

## 2.3 Don't worry, this is history now

Reliable mobile phone speech recognition and other biometric safety measures are too much of a hassle to try to bypass – there are always loop-holes and back-doors but they are mostly virtual

and anyway, most of the people have their iconic electronic world tailored as they wish – not as it is in reality. The same amount of difficulty applies for people to break through your temporary virtual world as if they wanted to make phone calls using your number without having your sim card.

## 2.4 A simple fact

But in the case of Dennis and me and our project, we wanted a model of our lives as real as possible, so that we'll be able to feed it with slightly modified actual data of our everyday life – just to study and research how the personal decision factor relates with a pseudo-random model of chance and choices when applied in the deterministic universe of our computers. That way we thought that we would explore the possibilities of interference among two distinct but almost identical dimensions by letting things that happening in the virtual world to reflect themselves in reality. In other words, we were dealing with the simple fact that we will never be sure for the state of specific material things that their exact representation existed also in our virtual world and vice-versa –unless we develop a way of maintaining our parallel but overlapping lives in some kind of order, something which is rather unlikely to happen!

## 2.5 Virtual Expo

To achieve this, we used transmissions of these Embedded WiSeNts that exist in our everyday life objects, to create a replica of our personal spaces. By calculating angles and distances of their position – plus the information provided by the industry design specifications - like the kind of object and its purpose & functionality- we ended up with a practically identical virtual interface that simulates our actual environment in bits and bytes. Our aim is to study the possibility to create the first virtual work environment, a work model that will be adopted by the most advanced and innovative hi-tech industries and not only. Our vision included small internet enterprises selling goods or services to update their web sites by introducing links to virtual halls, where their products will be demonstrated by several plugged-in employers or in many cases by just fictional avatars. No need any more for special designed 3D object libraries – since the Embedded WiSeNts chips allow every existing object to have its holographic representation already encoded and ready to be extracted and used any time.

It is as simple as this: You just need a database with your products – and your small virtual expo can be set up in minutes. Every change in your stock can be reflected immediately, and if you have a real hall that goods are demonstrated in shelves, the actual hall itself can be reproduced and be displayed and updated on request.

## 2.6 A day in the office

Anyone knows that a day in the office today is not as it was in the past...Working from home or from afar has been a reality for many years now, but in our model, you don't have to go to the office and you don't have to log in and use the server if you are urgently needed– you just have to plug your self in the office. There are of course rules that have to be followed: Every employer has to visit the same virtual office. Only small changes to your personal work space are allowed – just like in real life. The reason for this is that people's avatars are interacting in a virtual space that is created by data continuously transmitted by the *Embedded WiSeNts* existing in the actual environment. That

means that the report you just printed on your virtual cyber office in this new laser jet, it will be printed in exactly the same laser jet in the real office (if it exists such a thing like a real office) – and if there were a paper jam, you would be able to see it– and in more advanced versions to fix it - only of course if you're wearing clothes (or something similar) and you're not laying naked on the bed or elsewhere...

## 2.7 Dressing code

Because clothing is a very important aspect of life, and *Embedded WiSeNts* have changed the way we are considering them. If someone were watching me now – as I am sitting on this bench in Hyde Park – he could see a guy making funny gestures with his hand – this is because I am checking out some CDs Dennis has on his shelves. As my hands are moving, my jacket detects the movement of my arms and wrists, communicates them to my mobile, which is responsible to generate their representation. This happens with my trousers and my shoes of course – I only need to enable one option.

## 2.8 Lock or unlock

From day one they became widely accepted and used, these *Embedded WiSeNts* have added unlimited new possibilities in everyday life, and not only in the virtual world. Everything is interconnected and can be controlled from a distance with your mobile. You can lock or unlock your chest of drawers if you want whilst you're on the bus – it all depends if you want your boyfriend to find your diary or your girlfriend to find your hidden telephone agenda...

## 2.9 The best thing

There are so many different ways that these widgets are being used, that it is impossible to count them all...For example, have you ever seen these days a queue at the supermarket till? No, of course not – people that go to super markets don't have to search for goods in the shelves – they just let themselves be guided by these fancy new trolleys embedded with *WiSeNTs* to find the shelf they want – and then, all they have to do then is to fill the trolley up with the goods and then head for the exit – as every product package contains microchips that communicate with the exits' sensors, charging your card with the appropriate amount of money. No place for queues here in our hectic city life - no way also to bypass the supermarket entrance or exit if you don't have the right wise card...And the best thing of all is that the trolley comes back to the super market alone!

Other uses: Bins that are full informing bin men to pick them up, maps providing updated information for countries you select by just touching them, keys that can be reprogrammed to fit another lock, drink bottles and medicine or food packages informing you about the expire day or improper storing conditions etc. Want to have some fun? You can be a master in role playing, adventures or strategy games, but playing a game with your environment as a game level – this is something different... Imagine: Play well, play smart, gain lots of points or do the hack, and a new mission will appear on your screen – a secret level - a hidden easter egg – sent it to your friends to see if they dare to challenge you in your place! Everything interacts within and with 'out there'. From the simplest operation to the extreme one – everything can interfere with everything – as long there is some *Embedded WiSeNts* hidden somewhere.

And you don't need to be a computer geek to handle all that...Household & hi-fi equipment with *Embedded WiSeNts* are designed to wirelessly cooperate and communicate with no-need of a central computer –although if there is one, one can set up things like the parallel interactive virtual environment as we've done. If you don't need one – or you don't have time, don't worry. Every refrigerator or every microwave that respects itself have the ability to change a TV channel, open the door, pump up the volume or change radio stations at any time. Accordingly, you can observe the progress of your nice dinner burning in the oven–chicken with roast potatoes that you are preparing to impress her–whilst watching your favorite football match drinking beer on the sofa in the lounge. Just choose the right channel or press the right buttons or give the right order, and a yummy (at least most of the time) picture (plus information about the state of the cooking), will appear in your plasma screen, in your mobile TFT, or even in these new sunglasses from this tourist trap in the Greek islands.

## 2.10 The difference

As for the geeks like me and my friend Dennis, most discussed 3D-WebCam technologies have found a way through our personal space with the real excuse to model our life through a matrix of ultimately perplexed trigonometric equations and game design technology. Patch it up with a broad-band connection and your mobile cyber-space is more than a reality...It's really in our hands to decide to live in one or two or more identical or alternate realities.

And the difference between virtual and real world?...Well, it can be as big as living a secret life inside the real and a real life inside the virtual – or the opposite perhaps - and as small as the difference between the open window in our cyber-room - but with the same one being closed in reality...

## 3. THE ASSIGNMENT

-Are you finished with the CDs?

Dennis's voice produced colored sound waveforms in the CD's surface I was looking at – and his words started trailing in the CD label: 'C'mon let's check this thing...It seems quite interesting...'

I floated near the arm chair and had a look on his screen.

The assignment description was wide open in a new window so we started reading.

<< -- *Parallel Environments within Divine and Agnostic Algorithms of Creation* --

*Model and create a new environment using the Earth libraries we provide - minus the historical and contemporary ethical and philosophical classes.*

*With the use of evolution algorithms, and by fast forwarding them for time and space complexity aspects, simulate genetical transformations, aiming the creation of intelligence within the system. You are expected to experiment with the parameters until the creation of viable and self contained entities (who will have the power to interact intellectually between themselves and their environment) are created. From the moment of creation and afterwards you should observe the behaviour of those entities but you are not allowed to interfere.*

*Your objective is to be God, and you'll achieve this if the entities created develop analytical and philosophical qualities in the amount that they will start wondering from where and for what they're created for. Full marks will be granted if a form of technological advance is achieved by the entities. If this happens, as a bonus you are allowed to include in your project the full version of **Embedded WiSeNts** libraries – such this will ease the way of your entities to upgrade themselves the best way is possible in their future...>>*

#### **4. ACKNOWLEDGMENTS**

Many special thanks to Ms. Helen Georghiou for the grammatical, linguistic, and any other kind of support she has ever provided to me with her unique way, and to Mr. Dennis Korobov for the inspiration and feedback through our endless conversations. Special thanks to City University, London, UK, for its value as an unlimited resource of knowledge.

#### **5. RELATED BIBLIOGRAPHY**

Michael J. Kearns, Robert E. Schapire, Linda M. Sellie, "Toward Efficient Agnostic Learning, Machine Learning", v.17 n.2-3, p.115-141, Nov./Dec. 1994.

Goldman, S. A., Kwek, S. S., and Scott, S. D. 2001. "Agnostic learning of geometric patterns", J. Comput. Syst. Sci. 62, 1 (Feb. 2001), p. 123-151.

P. Sharma, S.-J. Lee, J. Brassil, and K. G. Shin, "Handheld routers: Intelligent bandwidth aggregation for mobile collaborating communities," HP Laboratories, Technical Report HPL-2003.

Mountain, D. and Liarokapis, F. 2005, "Interacting with virtual reality scenes on mobile devices", In Proceedings of the 7th international Conference on Human Computer interaction with Mobile Devices & Services (Salzburg, Austria, September 19 - 22, 2005). MobileHCI '05, vol. 111. ACM Press, New York, NY, 331-332.

G.Mair, J. Clark, R. Fryer, R. Hardiman, D. McGregor, A. Retik, N. Retik, K. Revie, "Hybrid virtual reality and telepresence utilising mobile phone technology", Proceedings of SPIE, Telem manipulator and Telepresence Technologies V, Boston, Massachusetts, 4-5 November 1998. pp 60 - 70. ISSN 0277-786X, ISBN 0-8194-2985-6.

Kallio, S., Kela, J. and Mantyjarvi, J. (2003), "Online Gesture Recognition System for Mobile Interaction.", IEEE International Conference on Systems Man and Cybernetics, 3, 2070--2076.

Stefani, O., Hoffmann, H., Patel, H., & Haselberger, F. "Pi-casso: Mobile Virtual Reality at office workplaces", Accepted for the proceedings of Computer Graphics and Computer Imaging, 2004.

# Sentient Future Competition: Father in Womb

T. Camilo, A. Rodrigues, J. Sá Silva,  
F. Boavida  
University of Coimbra  
Dep. of Informatics Engineering  
Pólo II, Pinhal de Marrocos,  
3030-290 Coimbra, Portugal  
+351 239 790 000

{tandre, arod, sasilva, boavida}@dei.uc.pt

E. Sá  
Superior Institute of Applied Psychology  
Rua Jardim do Tabaco, 34,  
1149 - 041 Lisboa, Portugal  
+351 218 811 700  
eduardosa@netcabo.pt

## ABSTRACT

The pregnancy is a differentiated phenomenon in the couple's life. Nowadays, the man tends to participate actively even more in this process. The main idea of this application is to transport some of the mother's experiences as a pregnancy woman (e.g. embryo movements), to her partner, the father. This paper presents the concept *Father in Womb*, which enables the father to follow the embryo growth, movements and sensations, providing mechanisms for interaction between both.

## 1. INTRODUCTION

Nowadays, more and more new technologies are being available to the final user, which gladly, absorbs the potentials of each new gadget. Wireless Sensor Networks (WSNs) are one of these technologies that will be generalized in future years. These networks are composed by numerous and very small sensors, which present several specific constraints, such as energy, memory and processing limitations, offering a huge range of applications.

Health monitoring is one of the most important applications of WSNs, since they can be used to both sense health problems such as heart diseases, helping to save lives, and allowing new forms of communication between living beings. This document presents the concept "Father in Womb", which was submitted to the Sentient Future Competition organized by Embedded WiSeNts project [1]. This concept allows the father to become more involved with his son from his first months on the mother's womb. Nowadays only women can really feel and interact with their embryos; the father's role is only to follow the physical and emotional changes of the mother. He can not interact with the embryo, feel their changes, their movements and their "life".

The remainder of this paper is organized as follows: section 2 presents the main concepts behind "Father in Womb" idea; it explores the principal mechanism that can be applied so that father and embryo start to be more interactive. Section 3 presents the main requirements of the communication technology. Conclusions are presented in the last section, Section 4.

## 2. RELATED WORK

Research and development of WSNs technology has been a collective effort linking university research centers, industry labs and government agencies, through a final goal: to build an architecture that enables WSN to become an accessible technology.

Nowadays there are no relevant projects that study the integration of WSN inside human body. However, in the area of monitoring healthcare there are several projects that intend to integrate this technology to support medical assistance. This integration provides new tools to help doctors on their work, such as augmenting data collection and real-time response, wherever the patients and doctors are. Patients will also benefit from this integration, since they will no longer be forced to stay in hospital beds (just because the monitoring machinery is static) and to regularly visit the doctors to report experienced symptoms, problems and conditions. With the integration of WSNs in these systems, patients will increase their mobility, due to the wireless capability of such nodes. The smart homecare architecture [2] is an example of such work, where the WSNs are used to collect data according to a physician's disclaimers, removing some of the cognitive load from the patient and providing a continuous record to assist diagnosis. This architecture integrates several elements, such as a real-time, long-term, remote monitoring and miniature wearable sensors. The authors claim that the integration with existing medical practices and technology can be used to provide assistance to the elderly and chronic patients. The SenseWear system, presented by Andre and Teller [3], is a set of wearable tools that are used to perform health monitor. The SenseWear Arm is an example of such a tool. It senses acceleration, heat flux, galvanic skin response and temperature. It has the ability to record all the data for later presentation and analysis. The applicability of these set of tools are among others: the study of sleep behaviors, competitive sailing, human-computer interactions and stress response in car and tank drivers. They can also be applied into any human, from children to old persons.

### 3. FATHER/EMBRYO INTERACTION

The mother's perception of the embryo's movements is considered one of the greatest landmarks during pregnancy, since it represents the first real perception of the embryo from the mother's point of view. Therefore, it increases the expectations referring to the future child. It is from the embryo's movements that the mother starts to distinguish the temperament attributes of the baby, besides it is the period when the interaction (mother/embryo) starts to be reciprocal. With this interaction it is possible to start understanding the baby's messages.

Nowadays, it is common to find men seated in the waiting room of the doctor's office, following their pregnancy wives to common medical attendances. This enforces the perception that men need to become even more integrated in the grow and in the birth of their future child. The gestation can and must be lived by the parents, as a couple.

During gestation, we observe physical and emotional adaptations both in women and men. It is not rare to find physical changes in the partner of pregnant women, as the increase of weight. An example of such conduct is the behavior of husbands in a tribe of Nova Guiné that, after the childbirth of his wives, stand lie down in bed as their women, presenting the same symptoms, as pain, discomfort, unreliability, depression and anxiety.

The technical idea behind *Father in Womb* is to deploy a WSN in the embryo premises. These sensors will monitor all the embryo activities, movement, sounds, images, temperature, heart beat, etc; helping the father to percept the behavior of his future baby. The WSN embryo will provide information with an actuator sensor network deployed in father body. The father will held several sensors (actuators) that will actuate according to the signals provided by the behavior of the embryo (Figure 1).

There are several embryo's movements that can be easily monitored, for instance the first hand or feet movements. But as the embryo grows up, the periodicity of movements will increase, as also the force applied, helping even more the monitoring.

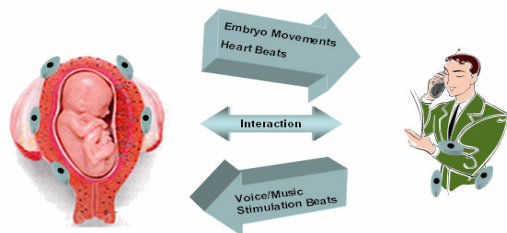

Figure 1- Sensor interaction between the father and the embryo

As the embryo gets bigger, new aspects can be introduced in the application, since the baby starts to react to external stimulations, as light and music, and also understands the physical sounds of

the mother, for example her heart beating. With this in mind, *Father in Womb* application intends also to incorporate some mechanisms that allow the father to communicate with his future child, such as a movement actuator that touches the embryo hand.

One of the most important embryo's movements occurs during the 7<sup>th</sup> month. In this month the baby's body is yet to short, and starts assuming a more comfortable position by turning his head upside-down, which will keep until the moment of the birth. This moment can also be monitored with our application. The father will know that the baby is performing accordantly to normal behavior.

In the family perspective the pregnancy is a delicate moment, since the women's body starts to change, the standard family behavior changes to new rhythms, the couple relationship can suffer slight revolutions and older brothers can feel jealousies. With the introduction of this application it is possible to minimize these kinds of problems, by allowing the father (or any other family element) to understand the women's behavior, due to a better share of embryo's relationship

### 4. CONCLUSION

In this document a new concept was presented, where the father is allowed to follow the embryo's life. *Father in Womb* permits the interaction between the parent and his future child, by exchanging sensations such as voice, movement and heart beats. With the possibility to create such an interaction, the women's gestation can become even more a mutual experience, where fathers stand for a more participate role in the embryo's life.

### 5. ACKNOWLEDGMENTS

The work presented in this paper is partially financed by the European project E-NEXT FP6 NoE.

### 6. REFERENCES

- [1] Embedded WiSeNts project, <http://www.embedded-wisents.org/index.html>, January 2006.
- [2] J. A. Stankovic, Q. Cao, T. Doan, L. Fang, Z. He, R. Kiran, S. Lin, S. Son, R. Stoleru, A. Wood, "Wireless Sensor Networks for In-Home Healthcare: Potential and Challenges", Workshop on High Confidence Medical Devices Software and Systems (HCMDSS), 2005
- [3] D. Andre, A. Teller, "Health. Care. Anywhere. Today", Future of Health Technology-2, IOS, 2005.

# Sentient Future Competition: LocuSent – large scale locust control system

Milo Lavén

Architect MSA, Independent designer

Parmmätargatan 9

112 24 Stockholm, Sweden

+46 70 4385812

milolaven@gmail.com

## ABSTRACT

LocuSent is a proposal for a massive monitor and control system for the desert locust. It's an extensive sensor network system that can survey vast and remote areas in order to prevent outbreaks and thereby prevent the terrible famine and the disastrous economical losses that follows in the trail of the locust.

## 1. INTRODUCTION

Locust is the name given to the swarming phase of short-horned grasshoppers of the family Acrididae. The origins and apparent extinction of certain species of locust—some of which reach 15 cm in length—are unclear. There are species that can breed rapidly under suitable conditions and subsequently become gregarious and migratory. They form bands as nymphs and swarms as adults both of which travel great distances during which they can strip fields rapidly and in so doing greatly damage crop yields. An exacerbating factor in the damage to crops caused by locusts is their ability to adapt to eating almost any food plant.

## 2. DESERT LOCUST

Plagues of desert locust, *Schistocerca gregaria*, have been recognized as a threat to agricultural production in Africa and western Asia for thousands of years. Locust scourges are referred to in the Christian Bible and the Islamic Koran. In some places, locust plagues have been held responsible for epidemics of human pathogens, such as cholera (this is because of the massive quantities of decomposing locust cadavers that would accumulate on beaches after swarms flew out to sea and drowned). Published accounts of locust invasions in North Africa date back to about AD 811. Since then, it is known that desert locust plagues have occurred sporadically up until the present.

Normally, the desert locust is a solitary insect that occurs in desert and scrub regions of northern Africa, the Sahel (region including the countries of Burkina Faso, Chad, Mali, Mauritania, and Niger), the Arabian Peninsula (e.g., Saudi Arabia, Yemen, Oman), and parts of Asia including western India. During the solitary phase (yellow area on map), locust populations are low and present no economic threat. After periods of drought, when vegetation flushes occur in major desert locust breeding areas (e.g., India/Pakistan border), rapid population build-ups and competition for food occasionally result in a transformation from solitary behaviour to gregarious behaviour on a regional scale (red area on map). Following this transformation, which can occur over two or three generations locusts often form dense bands of

flightless nymphs and swarms of winged adults that can devastate agricultural areas.

Desert locusts can consume the approximate equivalent of their body mass each day (2 g) in green vegetation: leaves, flowers, bark, stems, fruit, and seeds. Nearly all crops, and non crop plants, are at risk, including millet, rice, maize, sorghum, sugarcane, barley, cotton, fruit trees, date palm, vegetables, rangeland grasses, acacia, pines, and banana. Crop loss as a result of desert locust infestation is difficult to characterize, but it will be important for developing intervention strategies on a demonstrably cost-effective basis.

In 2004, West Africa faced the largest desert locust outbreak in 15 years. The costs of fighting this outbreak have been estimated to have exceeded US\$60 million and harvest losses were valued at up to US\$2.5 billion which had disastrous effects on the food security situation in West Africa. The countries affected by the 2004 outbreak were Algeria; Burkina Faso; the Canary Islands; Cape Verde; Chad; Egypt; The Gambia; Guinea; Libyan Arab Jamahiriya; Mali; Mauritania; Morocco; Saudi Arabia; Senegal; Sudan; Tunisia; Yemen and it was one of the main factors contributing to the famine in Niger.

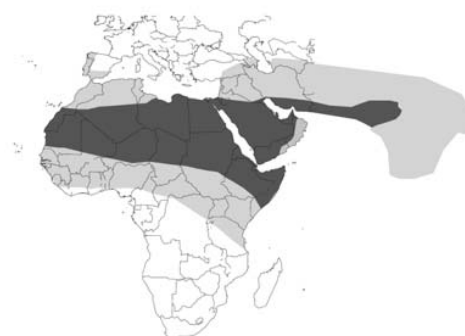

Distribution of desert locust.  
Recession Area  
Invasion Area

### 3. MONITORING AND CONTROLLING

Monitoring locust populations during recession periods to anticipate the onset of gregarious behavior and to locate locust bands and swarms for control operations during outbreaks and plagues is a difficult task that has become increasingly technologically sophisticated. Model-generated forecasts of locust population events and general patterns of swarm movement during outbreaks and plagues are attempted using weather and vegetation index information gathered from satellite platforms, meso-scale and synoptic-scale weather patterns, soil mapping, and probabilities based upon historical knowledge about locust population dynamics throughout the recession and plague distributions. Though useful, these tools are not always accurate or timely.

Despite the existence of such elaborate technology for roughly guiding locust scouts, the discovery of locust bands and swarms is accomplished through visual and audio surveillance.

Comparatively effective, quick-to-apply and cheap control methods became available in the late 1950s which were based on persistent organochlorine pesticides like dieldrin. These were discontinued when it became clear that they posed unacceptable risks to human health and the environment. The current methods require that pesticides are applied in a more precise manner directly onto locusts. This means more resources are needed to locate and treat infestations. At present the primary method of controlling desert locust swarms is with organophosphate insecticides applied in small concentrated doses by vehicle-mounted and aerial sprayers. The insecticide must be applied directly to the insects.

#### 3.1 Detection by sound

Grasshoppers, locusts, crickets and katydids belong to a group of insects known as orthopterans (meaning 'straight wings'). One of the most recognisable features of this group is their ability to produce sounds by rubbing together certain parts of their body. This is known as stridulation. Usually only the males sing to attract females but, in a few species, the female also produces sound. Grasshoppers and locusts have a row of pegs like a comb on their back legs. They scrape these pegs against the hard edges of the front wings to make sounds. Experts are able to identify the different species of grasshopper by the sound they make. Since each species has a slightly different arrangement of pegs on their legs, the sound they make is unique. It's therefore possible to distinguish the desert locust from other grasshoppers and insects by their sound only.

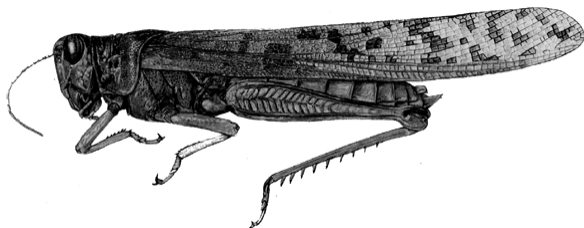

### 4. LOCUSENT

The LocuSent is triggered by the unique sound of the desert locust. Its sensors are set to detect the specific sound frequency produced by the stridulation of a swarm. Once it detects a swarm, it reports its id-number and position to a central monitor system.

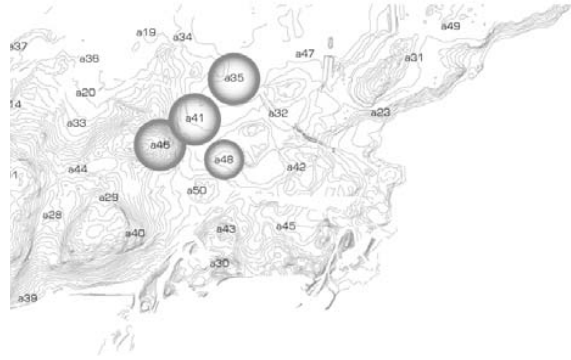

The desert locust is a difficult pest to control, and control measures are made more difficult by the large and often remote areas (16-30 million sq. km) where locusts can be found. Undeveloped basic infrastructure in some affected countries, limited resources for locust monitoring and control and political turmoil within and between affected countries further reduce the capacity of a country to prevent swarms.

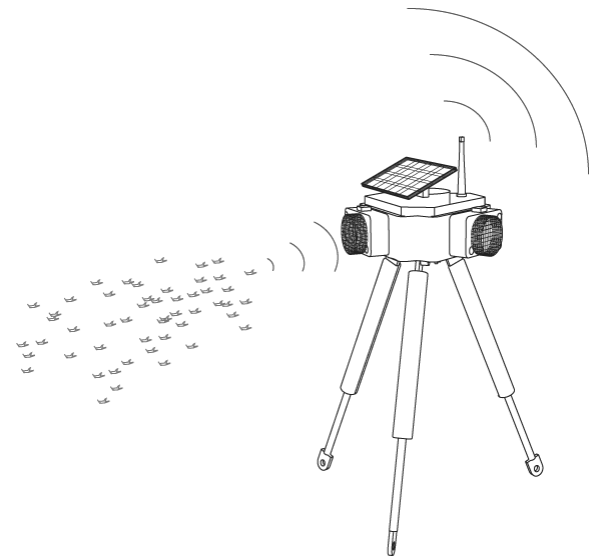

By placing large quantities of LocuSents in the affected areas, and making an extensive network of self-sustained monitor sensors that communicates with each others as well with a central monitor system, it would be possible to map the desert locust and prevent outbreaks. Once the sensors detects the sound of a bigger swarm of the desert locust, the LocuSent reports its id-number and its location to the surrounding LocuSents and to the central monitor system.



## 4.1 Design

The design in this proposal is a tripod model which is placed manually by jeeps, helicopters or small airplanes. The unit contains antenna, solar panel, GPS, transmitter, receiver and sonar sensors. It is also possible to make smaller, more simple and robust units that can be dropped from the air without having to land.

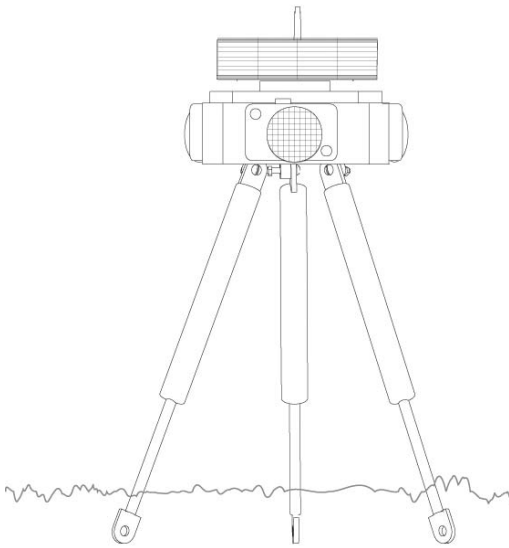

**LocuSent monitor unit**

existing swarms and creating “mine fields” that is completely harmless to everything except the desert locust.

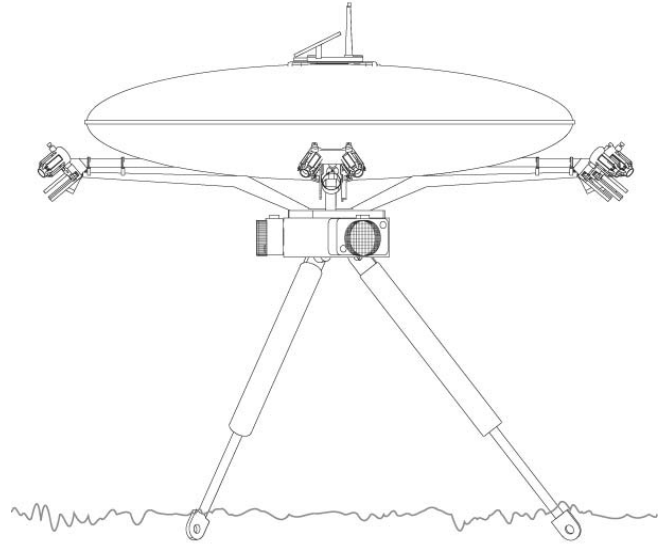

**LocuSent control unit elevation a**

## 4.2 Biologic control

A biological control product has been available since the late nineties. It is based on a naturally occurring entomopathogenic (i.e. infecting insects) fungus, *Metarhizium anisopliae* var. *acridum*. The species *M. anisopliae* is widespread throughout the world infecting many groups of insects, but it is harmless to humans and other mammals and birds. The variety *acridum* has specialised on short-horned grasshoppers, to which group locusts belong, and has therefore been chosen as the active ingredient of the product. The product is available under different names in Africa and Australia. It is applied in the same way as chemical insecticides but does not kill as quickly. At recommended doses, the fungus typically takes two to three weeks to kill up to 90% of the locusts. For that reason, it is recommended for use mainly in the desert, far from cropping areas, where the delay in death does not result in damage. The advantage of the product is that it affects only grasshoppers, which makes it much safer than chemical insecticides. Specifically, it allows the natural enemies of locusts and grasshoppers to continue their beneficial work. It is crucial to be able to detect locust as early as possible in these remote areas. In this phase the *Metarhizium anisopliae* bacteria is a very good substitute for the dangerous chemical insecticides necessary in later phases and closer to inhabited areas.

By equipping the LocuSent with a tank for the bacteria and a spraying system that is triggered by the sound of the locust, it would be possible, not only to monitor, but also to fight the locust in remote and hard accessed areas without going there. It is also possible to put up barriers of LocuSents in the expected route of

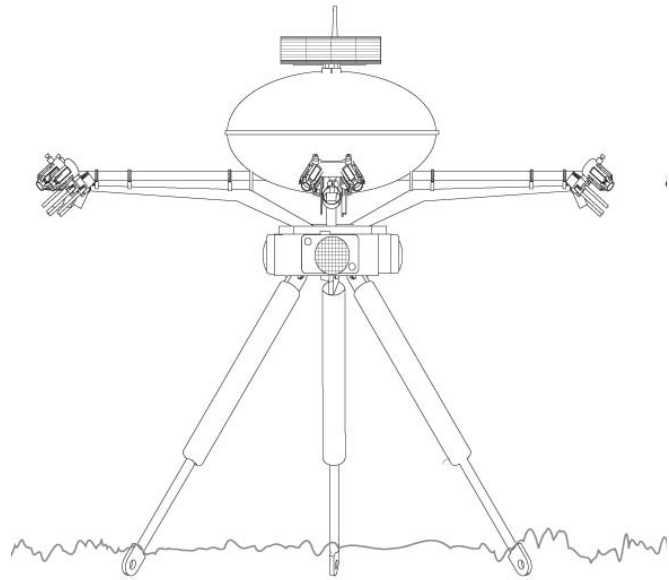

**LocuSent control unit elevation b**

## 5. ILLUSTRATIONS



# Sentient Future Competition: PerSens - Personality Sensors

Zinaida Benenson  
Department of Information  
Technology

Uppsala University  
Lägerhyddsvägen 2, 75237 Uppsala

zina@cs.rwth-aachen.de

Mesut Güneş

Department of Computer Science  
Informatik 4

RWTH Aachen University  
Ahornstraße 55, 52074 Aachen

guenes@cs.rwth-aachen.de

Martin Wenig

Department of Computer Science  
Informatik 4

RWTH Aachen University  
Ahornstraße 55, 52074 Aachen

wenig@cs.rwth-aachen.de

## ABSTRACT

The deployment of sensor networks in the area of social relationships is very attractive, since by assisting people it may improve cooperation and prevent conflicts.

We propose the Personality Sensors system (PerSens), which consists of a sensor network embedded into the clothes and other accessories of the person. PerSens will determine the personality type of the owner. Besides, it will also notify the owner of his behaviour in the current context and how it may appear to his counterparts.

## 1. INTRODUCTION

In all times, misunderstandings among social groups and individuals have led to conflicts. In a family, misinterpretation of the behaviour of the parents, children or partners may lead to loss of trust. In the worst case, this may lead to drifting apart of families and to divorces. The performance of working teams in companies depends heavily on the attitude of the individual members. This situation gets even more complicated in international working groups.

The improvement of social relationships will reduce potential conflicts and can help each and every person in their daily life. This can be achieved if the interacting parties are aware of their own characters and the characters of the counterparts. Of course, all people are different. However, some psychological theories classify people according to their personality types. One of these systems was invented in the beginning of the twentieth century by Myers and Briggs [1] and was successfully used by industry companies to form project teams which worked more efficiently. Their work was extended to relationship in the normal life by David Keirsey in his books [2]. Gunter Dueck applied this theory to the people working in the area of computer science and mathematics [3].

One of the challenges in applying psychological classifications is the development of tools for determining to which category a particular person belongs. The most frequently used tools are questionnaires. However, this method is unreliable. To name just a few problems, people usually cannot appraise themselves objectively, they may try to look “better” while answering the questions, or they may even misunderstand questions. Besides,

the questionnaires are tiresome and boring. For example, there are five different questionnaires with up to 144 questions for the Myers-Briggs Type Indicator. These disadvantages may lead to incorrect classifications, and thus renders even the most promising theories useless in the practice.

The proposed system, Personality Sensors (PerSens), consists of a sensor network embedded into the clothes and other accessories of the person. PerSens will determine the personality type of the owner. Besides, it will also notify the owner of his behaviour in the current context and how it may appear to his counterparts.

The remainder of the paper is as follows. In Section 2, we give possible application scenarios for the use of PerSens. Subsequently in Section 3, we describe PerSens in detail.

## 2. SCENARIOS

We describe possible applications of PerSens on two selected examples from totally different domains. The first example discusses the deployment of PerSens in professional life, and the second example covers family relationships.

### 2.1 Project meeting

Consider a team in an important project meeting. As usually, some participants talk a lot, sometimes they even change their minds several times during the meeting. This is their method to find solutions. Other team members are very quiet. This can be misinterpreted as being uninterested. However, they may be listening carefully to the discussion and take time to consider the given arguments. In this situation, both personality types have a big problem. The “active” people would not listen to the “passive” colleagues. On the other hand, the “passive” people cannot make the others listen to them. As a consequence, suboptimal, or even wrong decisions might be made, and both personality types blame each other for the project failure.

The deployment of PerSens in the meeting informs each participant about the personality of the others. This enables the project leader and also the whole group to include every team member with regard to his personal strengths. PerSens determines the most efficient meeting schedule, such that “active” people have the opportunity to discuss things, and the “passive” people have the opportunity to observe the discussion. Then PerSens notifies the participants about the most appropriate time to change the roles, such that “active” people have to listen,

and the “passive” people have to talk. This way, all members are given the opportunity to learn new skills (listening vs. talking) and the project benefits from the diversity of ideas.

## 2.2 Family Quarrel

Misinterpretation of the behaviour of the family members often leads to serious conflicts starting from trivial causes. Partners may lose trust to each other, drift apart, divorce. Children and parents may part for years, or even for the whole life.

Alice and Bob, a married couple with different personality types, are going to have a quiet evening. Both of them already made concrete plans. Suddenly, their friends call and suggest to go out. According to her spontaneous personality type, Alice is willing to accept. In contrast, Bob prefers well planned activities and refuses to join. They spend the remainder of the evening in a blazing row, which will not be pictured here.

Now suppose that Alice and Bob got tired of their rows and go to the psychologist Charlie in order to improve their family life. Charlie installs PerSens for them, which eventually determines their personality types. PerSens helps them to understand each other better, and to find compromises. For example, they may agree to accept every other of unforeseen invitations.

## 3. THE PerSens SYSTEM

First, we describe the requirements for intra PerSens which is responsible for determining the mood and condition of the owner and notifying him. Subsequently, the interaction of different PerSens’ is described.

### 3.1 Intra PerSens: The Personality Type

The sensors are integrated into the clothes and accessories of persons. The sensors measure body temperature, heart rate, blood pressure, perspiration, and brain impulses. Furthermore, these data is connected to temporal and spatial contexts. This data will be transformed into information about the person’s psychological condition. On top of the psychological condition, PerSens will generate advices and notify the owner.

PerSens has to be adapted to the owner in order to render useful

information. There will be a settling time during which the system determines an initial personality type of the owner. After this period, the system is ready to assist the owner. Nevertheless, there will be continuous observations of the owner to ensure the recency and validity of the assumed personality type.

As PerSens is integrated into clothes, it needs a mechanism to identify the current carrier. This can be done by measuring some characteristics like walking type, typical heart rates, and other unique properties of the person.

### 3.2 Inter PerSens: Interaction

When persons’ PerSens meet other persons’ PerSens, they interact by sharing personal data. Of course, this implies the agreement of the respective partners to share information about their personality type and current mood. Given this agreement, PerSens may exchange information with respect to the current context and suggest appropriate behaviours to the respective owners. The context determines the amount and the quality of the exchanged data. In the following, we give two illustrating examples.

- The-Mother-Child-Dog-Story: Consider a mother together with her child meeting a loose dog. In this situation, the nervousness of the mother should not be evident to the child.
- The-Business-Negotiation-Bluff-Story: When business partners negotiate contracts, they have to conceal their emotions such as pleasure, anger, or uncertainty. Nevertheless, PerSens can help to find a compromise faster, and to improve business relationship.

## 4. ACKNOWLEDGEMENTS

We are grateful to Anna Chudnovsky [4] for the fruitful discussions about the application of the Myers-Briggs theory to real life.

## 5. REFERENCES

- [1] The Myers and Briggs Foundation, <http://myersbriggs.org/>
- [2] Keirse, David, Please understand me I&II, <http://keirse.com>
- [3] Homepage of Gunter Dueck, <http://www.omnisophie.com>
- [4] Chudnovsky, Anna, Читать человека как книгу (Reading people like a book, in Russian), <http://2a.ru/>

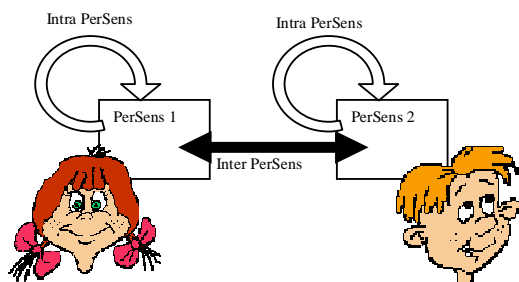

# Sentient Future Competition: Sentient Guardian Angel

Marcus Christ  
+49 6151 937 8372

Gerald Eichler  
+49 6151 937 4594

Klaus Mieth  
+49 6151 937 3545

Stefanie Richter  
+49 6151 937 3573

Jens Schmidt  
+49 6151 937 8385

Jens Wukasch  
+49 6151 937 5584

{marcus.christ,gerald.eichler,klaus.mieth,stefanie.richter;schmidt,jens.wukasch}@t-systems.com

## ABSTRACT

This proposal emphasizes the use of wireless sensor networks to omit dangerous traffic situations for a variety of participants in road traffic: pedestrians (elderly, disabled or simply careless people and children), cyclists or even pets. Communication between the networks of the participants is used to detect the threat at an early stage giving adequate warnings, alerts, recommendations and instructions to all participants involved. In our example we describe a pedestrian-car-interaction. However, the approach is applicable to all possible participants of road traffic.

## 1. STATE OF THE ART

The statistics for traffic accidents show increasing rates for accidents with children or seniors involved [1]. Noise reduction of motorized vehicles is estimated to contribute to this tendency as well as increasing mobility and an increased average age of population. Although today's vehicles are equipped with an increasing number of sensors, making life for drivers and passengers easier and safer there are no systems assisting pedestrians or cyclists. Examples for driver assistance systems are e.g. DaimlerChrysler's Distronic, a radar based distance control [2] and DaimlerChrysler's Dedicated Short Range Communication (DSRC) system under development [3].

Clothes attached with different kinds of sensors and actors (I-wear [4]) can be used as appropriate equipment for pedestrians and cyclist to enable "Sentient Guardian Angel" features.

## 2. VISION

The sensor system is supposed to prevent dangerous traffic situations in everyday life. Imagine a handicapped or careless person intending to cross a street. Such a pedestrian's perception and attention is limited.

The following pictures illustrate such a situation as well as the point of view of the pedestrian and the vehicles driver.

A handicapped or careless pedestrian intends to cross the street. As a car is approaching he does not recognize the vehicle (Figure 1) However, the Sentient Guardian Angel builds an ad-hoc network exchanging information. The system evaluates the information and recognizes the approaching car (Figure 2).

Furthermore, the car driver might not realize the pedestrian either, e.g. due to bad weather. The Sentient Guardian Angel recognizes the pedestrian and sends warnings to the driver. This enables the driver to react to the "abruptly" emerging person (Figure 3).



Thus, the system is able to guard in several ways:

- (1) The pedestrian could be warned by the system, e.g. by causing



Figure 2: Sentient Guardian Angel alerting the pedestrian.



Figure 3: Sentient Guardian Angel alerting the driver.

vibration on the concerned side of the persons body or causing noise or other warnings.

(2) The pedestrian draws attention due to actors. The person is illuminated or the clothes are separating colored light

(3) The vehicle driver is warned by the system, either by signing flashes next to the car's dashboard or causing noise or other warnings.

(4) Finally the vehicle warns the pedestrian by flashing up the headlights of the car or using the car's horn.

### 3. TECHNICAL ARCHITECTURE

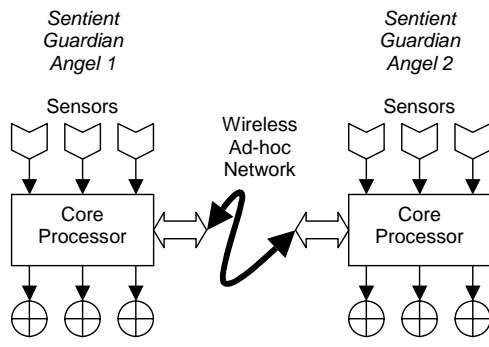

Figure 4: Basic architecture of the system

The basic equipment of the Sentient Guardian Angel is a system consisting of the following components:

- Sensors (to detect and quantify environmental factors)
- Actors (to indicate dangerous situations and give appropriate advice)
- Wireless communication components (to build ad-hoc networks between involved parties)
- Core processor (to control components and predict critical situations)

Such a system will be designed for each traffic participant following its special needs regarding its role (pedestrian, cyclist, motorist) and its characteristics (child, elderly person, disabled persons). Therefore different sensors and actors are needed.

Different research activities aim at highly miniaturized and autonomously acting systems (hardware, platforms) using wireless communication, e.g.  $\mu$ -OS such as TinyOS or ContikiOS [5] or e-Grain [6]. Therefore the dimensions of the necessary components for the Sentient Guardian Angel are expected to be very small-sized.

### 3.1 Components of the System

#### 3.1.1 Sensors

Sensors are needed for two main reasons.

Firstly, to detect the personal behavior in a certain traffic situation, which is characterized by a "motion vector". Therefore location (position) and orientation (compass) as well as velocity and acceleration sensors are needed. Alternatively precise location sensors could be of interest.

Secondly, sensors detecting the presence of other traffic components are required. This could be stationary equipment like traffic signs or traffic control e.g. traffic lights or dynamical factors like other traffic participants. Basically, there are two ways of detection: Local detection by noise pattern sensors, video pattern sensors, or ultrasonic sensors and intercommunication sensors by active near and medium field communication using active wireless technologies like

- RFID tagging
- IrDA and Bluetooth communication, and
- Classical RF transmission on an ISM band.

#### 3.1.2 Actors

Actors are specific to the role and the characteristic of a traffic participant. While motorists will have a specific unit integrated in the car control system with audio and video output the actors of pedestrians should be smoothly integrated in functional clothing. The so-called "Active Jacket" could have all components at an appropriate place. Examples are:

- A speaker in the neck for noise alarm and speech output
- Vibration or thermo actors in the sleeves
- Flash lights to warn other traffic participants

It's easy to be seen that there are two possible ways of indication, i.e. either to warn the endangered person itself or to warn others.

In addition, augmented reality technologies can be used for visualization of alerts or critical situations. Visualization can be done on the windscreen in cars/tram/buses, on visors of helmets and on augmented reality enabled eyeglasses.

#### 3.1.3 Wireless communication / Ad-hoc networks

While sensors and actors mainly interact with the local core processor, the wireless communication components are responsible for interaction between traffic participants. "Ad-hoc networks" are built as soon as a minimum of two potential entities approach each other. Multiple threads have to be handled in parallel. Each node in an ad-hoc network is able to act as a router to relay connections or data packets to their destinations. This is necessary if more than two objects are part of the ad-hoc network. Ad-hoc routing protocols are under standardization.

#### 3.1.4 Core processor

While the initial approach relies on a core processor to coordinate sensors, actors and wireless communication components in a second step the local equipment of a traffic participant could be built of a modular sensor network itself. Thus, "Active Jackets" could be designed more easily.

### 3.2 System Operation

As soon as an ad-hoc network connection is established, there will be an exchange of information:

- The "motion vector", which allows a prediction of further movements and a calculation of potential crash situations.
- The "characteristic set", which informs about the role and characteristic of the traffic participant.

The correlation of two motion vectors allows a prediction of potential crash situations. Therefore any change of one vector has to be reported to the other party. As long as there is no crash course identified, no action is required.

The characteristic set has to be exchanged only once between involved parties. It is quite important as children, elderly people or disabled people show quite a specific behavior within traffic situations. This influences the selection of actors and looks for specific information for the opponent party e.g. a driver could be informed about a deaf person intending to cross the road. The local decision finding, implying several steps like "indication", "warning" and "advice" will be supported adequately.

The power supply of an "Active Jacket" could be realized by distributed generators using

- Temperature differences,
- Movements by pressure generation,
- Movement by acceleration generations.

#### **4. APPROACH**

The first step to enable the Sentient Guardian Angel is the development of sensor systems for pedestrians, cyclists and for motorists, respectively their vehicles. These sensors are able to build ad-hoc networks and exchange information. According to the part of the system (pedestrian or vehicle) the information is evaluated and the sensor system provides the car driver or the pedestrian with warnings of a potentially dangerous situation.

After the establishment of such a sensor system road infrastructure, its components e.g., traffic signs can be integrated by means of tagging mechanisms. This will help the sentient system to evaluate information regarding the environment of the situation.

As first step we propose to start with the requirements of pedestrians having handicaps like deafness. In further steps one might consider other handicaps, elderly persons, children and pets.

The Sentient Guardian Angel is supposed to guard pedestrians. It sends warnings and advices to either the vehicle driver or the pedestrian. Later it could be an assistant to help a vehicle driver to automatically react in dangerous situations.

Beyond personal guarding, the Sentient Guardian Angel infrastructure might contribute to telematics and navigation appliances.

#### **5. ACKNOWLEDGMENTS**

Our thanks to T-Systems Enterprise Services GmbH, for providing the creative atmosphere to deploy innovative ideas.

#### **6. REFERENCES**

- [1] <http://www.im.nrw.de/sch/736.htm>
- [2] <http://www.daimlerchrysler.com/dccom/0,,0-5-7182-1-465281-1-0-0-0-0-0-243-7165-0-0-0-0-0-0,00.html>
- [3] <http://www.daimlerchrysler.com/dccom/0,,0-5-7182-1-465281-1-0-0-0-0-0-243-7165-0-0-0-0-0-0,00.html>
- [4] <http://www.i-wear.com/>
- [5] <http://www.sics.se/>
- [6] <http://www.egrain.org/>

## Author Index

- Andretto, Matteo 32
- Bairaktaris, Panagiotis 86  
Baumgartner, Karl 38  
Beferull-Lozano, B. 10  
Benenson, Zinaida 18, 96  
Benini, Luca 26  
Beutel, Jan 58  
Bicchi, Antonio 30  
Bitsch, Jó Ágila 22  
Blom, Sebastiaan 32  
Boavida, F. 90  
Busse, Marcel 20
- Caamaño, Antonio J. 12  
Camilo, T. 90  
Capone, A. 36  
Cesana, M. 36  
Chen, Jiming 56  
Chiti, Francesco 4  
Christ, Marcus 98  
Ciabatti, Michele 4  
Coers, Alexander 14  
Collodi, Giovanni 4  
Coulouris, George 66  
Crepaldi, Riccardo 32
- Danesi, Antonio 30  
Daskalopoulos, I. 52  
De Caux, Phillip R. 84  
Decotignie, Jean-Dominique 50  
Denkinger, Katharina 22  
Di Palma, Davide 4  
Diall, H. 52  
Dietterle, D. 60  
Dini, Gianluca 30  
Dyer, Matthias 58
- Ebert, J.-P. 60  
Effelsberg, Wolfgang 20  
Eichler, Gerald 98  
El-Hoiydi, Amre 50  
Endler, Markus 68  
Espina, J. 60
- Fabeck, Gernot 18  
Falck, T. 60  
Farella, Elisabetta 26  
Filippini, I. 36  
Flouri, K. 10
- Frank, Christian 44  
Fratta, L. 36  
Friso, Simone 32
- Garcés, David 54  
Girao, Joao 48  
Gonçalves, Gil Manuel 6  
Güneş, Mesut 96
- Haenselmann, Thomas 20  
Hailes, S. 52  
Hansen, Jens A. 24  
Hansen, Martin B. 2  
Heikkilä, Tapio 8  
Holzapfel, Markus 14  
Hozoi, Adrian 28
- Kellerer, Wolfgang 44  
Krohn, Albert 54
- Landsiedel, Olaf 22  
Lang, M. 60  
Lavén, Milo 92  
Lebres, Paulo 6  
Li, Hongbin 56
- Manes, Antonio 4  
Martin, Kevin 58  
Miethe, Klaus 98  
Morla, Ricardo 74  
Mottola, Luca 16  
Müller, Hans-Christian 14
- Nielsen, Thomas D. 24  
Noda, Chie 44
- Öberg, Lasse 34
- Papp, Zoltan 28  
Pias, Marcelo 66  
Picco, Gian Pietro 16  
Piens, Irina 66  
Pinto, José 6  
Pizziniaco, L. 36
- Raja, K. 52  
Ramos, Javier 12  
Reyes, Eduardo Morgado 12  
Richter, Stefanie 98  
Ringwald, Matthias 62  
Robert, Stephan 38  
Rodrigues, A. 90  
Roduner, Christoph 44



Römer, Kay 62  
 Roussos, G. 52  
  
 Sá, E. 90  
 Sala, Matthias 71  
 Sallinen, Mikko 8  
 Santini, Silvia 42  
 Savino, Ida M. 30  
 Scheller, Frieder 60  
 Schiavi, Riccardo 30  
 Schjøler, Henrik 2, 24  
 Schmidt, Jens 98  
 Schoch, David 71  
 Schoch, Odilo 54  
 Schwefel, Hans Peter 2  
 Sgroi, Marco 44  
 Shen, Xingfa 56  
 Sigalas, Markos 40  
 Silva, J. Sá 90  
 Sousa, Alexandre 6  
 Sousa, João 6  
 Sun, Youxian 56  
  
 Torfs, T. 52  
  
 Tsakalides, P. 10  
  
 Uhlrich, Günther 60  
  
 van der Mark, Peter 28  
 Van Hoof, C. 52  
 Vinagre, Juan José 12  
 Vouros, George 40  
  
 Wang, Zhi 56  
 Wehrle, Klaus 22  
 Wenig, Marin 96  
 Westhoff, Dirk 48  
 Wukasz, Jens 98  
  
 Xu, Youzhi 34  
  
 Yoneki, Eiko 80  
 Yücel, Mustafa 62  
  
 Zanella, Andrea 32  
 Zappi, Piero 26  
 Zhao, Jun 56  
 Zorzi, Michele 32