





An Overview of Soft Robotics

Review Article

Author(s):

[Yasa, Öncay](#) ; [Toshimitsu, Yasunori](#) ; Michelis, Mike Y.; Jones, Lewis S.; Filippi, Miriam; [Buchner, Thomas](#) ; [Katzschmann, Robert K.](#) 

Publication date:

2023-05

Permanent link:

<https://doi.org/10.3929/ethz-b-000595503>

Rights / license:

[Creative Commons Attribution 4.0 International](#)

Originally published in:

Annual Review of Control, Robotics, and Autonomous Systems 6, <https://doi.org/10.1146/annurev-control-062322-100607>

An Overview of Soft Robotics

Oncay Yasa,* Yasunori Toshimitsu,* Mike Y. Michelis,*
Lewis S. Jones, Miriam Filippi, Thomas Buchner,
and Robert K. Katzschmann

Soft Robotics Laboratory, Institute of Robotics and Intelligent Systems, Department of
Mechanical and Process Engineering, ETH Zurich, Zurich, Switzerland; email: rkk@ethz.ch

Annu. Rev. Control Robot. Auton. Syst. 2023. 6:1–29

First published as a Review in Advance on
November 14, 2022

The *Annual Review of Control, Robotics, and
Autonomous Systems* is online at
control.annualreviews.org

<https://doi.org/10.1146/annurev-control-062322-100607>

Copyright © 2023 by the author(s). This work is licensed under a Creative Commons Attribution 4.0 International License, which permits unrestricted use, distribution, and reproduction in any medium, provided the original author and source are credited. See credit lines of images or other third-party material in this article for license information.

*These authors contributed equally to this article

**ANNUAL
REVIEWS CONNECT**

www.annualreviews.org

- Download figures
- Navigate cited references
- Keyword search
- Explore related articles
- Share via email or social media

Keywords

actuation, design, sensing, simulation, modeling, control, machine learning, manipulation, locomotion, robotic interaction

Abstract

Soft robots' flexibility and compliance give them the potential to outperform traditional rigid-bodied robots while performing multiple tasks in unexpectedly changing environments and conditions. However, soft robots are yet to reveal their full potential; nature is still far more advanced in several areas, such as locomotion and manipulation. To understand what limits their performance and hinders their transition from laboratory to real-world conditions, future studies should focus on understanding the principles behind the design and operation of soft robots. Such studies should also consider the major challenges with regard to complex materials, accurate modeling, advanced control, and intelligent behaviors. As a starting point for such studies, this review provides a current overview of the field by examining the working mechanisms of advanced actuation and sensing modalities, modeling techniques, control strategies, and learning architectures for soft robots. Next, we summarize how these approaches can be applied to create sophisticated soft robots and examine their application areas. Finally, we provide future perspectives on what key challenges should be tackled first to advance soft robotics to truly add value to our society.

1. INTRODUCTION

Unlike traditional rigid-bodied robots, works on soft robots take nature as an inspiration to create capable, compliant machines that can perform multiple complex tasks concurrently (1). Traditional rigid-bodied robots are commonly programmed to efficiently perform a single task in well-defined settings; however, they often have a limited ability to adapt to unexpectedly changing situations due to the rigidity of their building materials (2). Because soft robots are made mostly of materials whose elasticities are comparable to those of soft biological systems, they can move with high degrees of freedom (DOFs), interact with their surroundings in a compliant and safe manner, and adapt quickly to suddenly changing situations (3).

Soft robots have already presented their potential to change our daily lives. For example, combining soft robotic mechanisms with traditional rigid-bodied robots has found use in dexterous object manipulation tasks within industrial settings (4–6). In addition, soft robots have explored fragile deep-sea animals to help us better understand our world (7–9). Moreover, there have been investigations into using minimally invasive soft robots for medical purposes, such as endoscopy (10), surgery (11), and drug delivery (12) in delicate locations within the body.

Despite these promising developments, soft robots still have not been able to fully demonstrate their hoped-for potential to revolutionize our daily lives. In this context, future research efforts should ideally concentrate on three aspects: (a) engineering new materials that appropriately interface soft and rigid robotic components and allow for the creation of multifunctional soft robots that possess lifelike properties, such as self-healing, sensing, and growth; (b) better understanding the principles behind soft robots' dynamics with computational tools specifically developed for them; and (c) enhancing existing soft robots' performance by using control and learning architectures that are more suitable for them.

In this review, we provide an overview of the state of the art in soft robotics and discuss steps that could be followed to realize future soft robots. We first examine the working mechanisms of the five most predominantly used soft robotic actuation modalities. Then, we introduce the modeling and simulation tools that have been recently developed to make the underlying physics of soft robots tractable. After that, we present various control approaches and controller architectures that have been specifically created to control soft robotic platforms. Next, we examine the sensor technologies that can be used to create more proprioceptive soft robots. Finally, we discuss the common application areas of soft robots and conclude our review with our perspective on required future advances in the field of soft robotics.

2. SOFT ROBOTIC ACTUATION MODALITIES

Actuators are the artificial muscles of soft robots that allow them to deform and move. The selected actuation modality greatly influences soft robots' design, fabrication, modeling, control, and performance. Therefore, we start our review by analyzing the working principles of the most promising soft robotic actuation modalities (fluidic, electrostatic/electrochemical, thermal, magnetic, and biohybrid) and discuss their influence on soft robots' design and fabrication.

2.1. Fluidic Actuation

Fluidic actuation is one of the most commonly utilized modalities to controllably deform soft robots. It achieves motion through the spatiotemporal control of the fluidic pressure inside a soft robot's internal inflatable cavities (i.e., channels and chambers). Soft robots that are actuated with this modality are composed mainly of elastomeric materials, and they have one or more inextensible reinforcement layers, such as fibers, fabrics, or stiffer materials, around parts of their internal inflatable cavities. These reinforcements constrain the direction of deformation to achieve

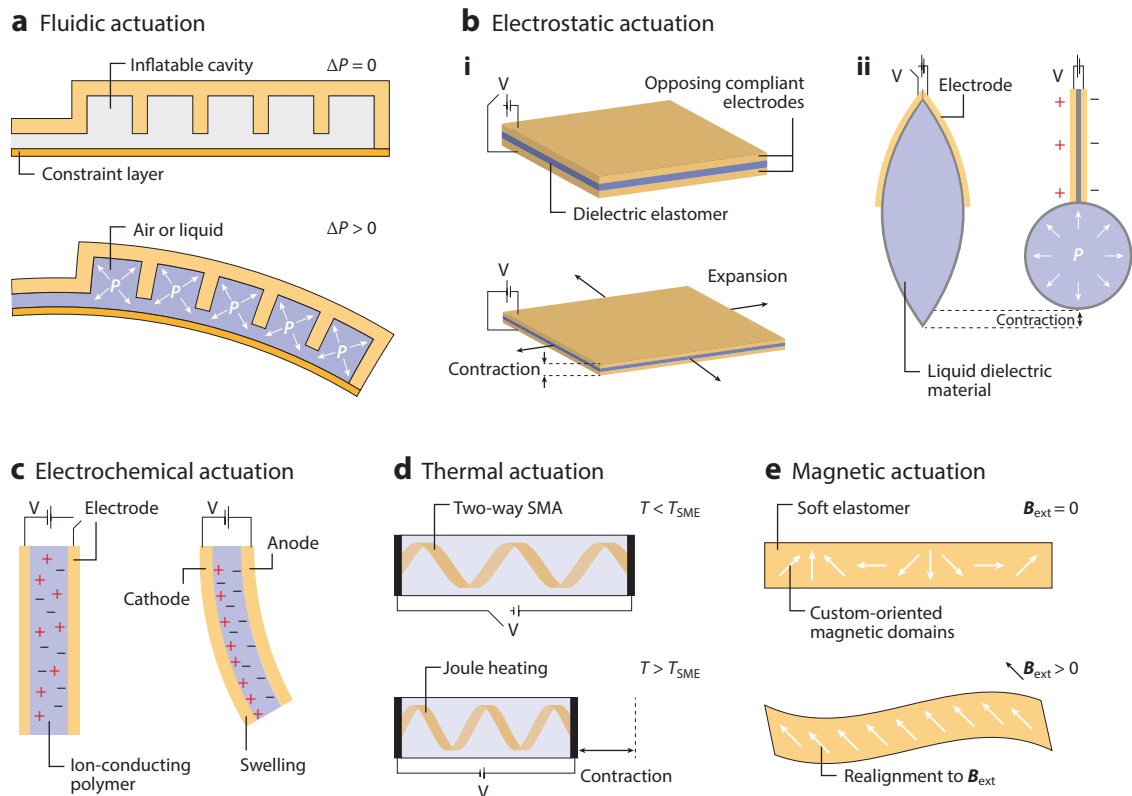

Figure 1

The working mechanisms of the most promising soft robotic actuation modalities. (a) Fluidic actuation. The spatiotemporal control of the fluidic pressure P inside soft robots' internal inflatable cavities leads to actuation. (b) Electrostatic actuation. Attractive electrostatic forces acting on two compliant opposing electrodes squeeze the sandwiched solid dielectric materials and lead to deformation (subpanel *i*), and attractive electrostatic forces coupled with hydraulic pressure lead to actuation (subpanel *ii*). (c) Electrochemical actuation. The migration of free cations toward the cathode causes a swelling effect and creates a stress gradient that leads to deformation. (d) Thermal actuation. Joule heating above a certain temperature T_{SME} causes a configuration change in SMAs, which then causes actuation. (e) Magnetic actuation. Magnetic materials are entrapped in soft, deformable structures. An external magnetic field B_{ext} causes a spatiotemporal alignment of the entrapped magnets toward that field, leading to the structure's deformation. Abbreviations: SMA, shape-memory alloy; SME, shape-memory effect; V, voltage.

the desired deformation and motion. Pumps pressurize and depressurize the internal inflatable cavities with fluids, such as air or water, and the internal fluidic stress generated by this process deforms the robot's body (**Figure 1a**). The deformation rate can be tuned by controlling the amplitude and duration of the fluidic pressure in each cavity.

The inflatable cavities and surrounding structure can have different designs and segment morphologies, such as cylindrical (13), pleated (14), or ribbed (15), depending on the intended robotic operations (16). Their design determines a soft robot's actuation speed. The actuation speed can be enhanced by reducing the amount of fluid that is needed to inflate the cavities, allowing for a rapid internal pressure change (14). Moreover, each segment's morphology has its own unique advantages and disadvantages that affect the robot's performance and operational lifetime (16). Inextensible reinforcement layers, also known as constraint layers, can be created by simply increasing the thickness of elastic materials or by using stiff materials or inflexible fabrics.

Most fluidic soft robots are pressurized by rotary or reciprocating pumps, where the volumetric displacement is driven by rotating gears, screws, plungers, or diaphragms (17).

The main advantages of fluidic actuation are that it generates a wide range of motion, including bending, twisting, and elongation, and can achieve high forces. Furthermore, continuous power is not needed to keep the robots in their actuated state, since they can stay in that state simply by closing their valves. The main disadvantages of fluidic actuation are that it is prone to puncture, is not energy efficient, and is difficult to accurately control due to the nonlinear material response and high susceptibility to failure under large payloads.

2.2. Electrostatic/Electrochemical Actuation

Electrostatic/electrochemical actuation happens through the direct translation of electrical energy to soft body deformation (and heat). Several different types of soft robots operate with these actuation modalities. The designs of each actuator type resemble capacitors—two opposing electrodes separated by a dielectric (in the case of electrostatic actuation) or an ion-conducting (in the case of electrochemical actuation) material.

2.2.1. Dielectric elastomer actuators. Dielectric elastomer actuators (DEAs) work with attractive electrostatic forces acting on two opposing stretchable electrodes, which are separated by a compliant dielectric layer of solid material (18). DEAs can be powered by stimulating the opposing electrodes (reported voltages in the range of 0.3–27 kV); the voltage depends on the design, material properties, and intended actuation strains (19, 20). When they are actuated, the opposing electrodes attract each other and squeeze the solid dielectric material layer through Maxwell stress (**Figure 1b**, subpanel *i*). Dielectric material layers squeeze orthogonally, and they extend parallel to the opposing stretchable electrodes under electrical fields due to their incompressible nature (21). DEAs can present different deformation patterns, such as contraction, elongation, and twisting, according to their arrangements (22). It is easy to control DEAs because there is a direct connection between the applied voltage and the magnitude of deformation; moreover, the elastomeric forces from the dielectric materials reset the DEAs' shape when the actuation voltage is lowered.

Most DEAs are manufactured using spray or spin coating and blade or slot-die casting (23). There is a general drive in this field to lower the required actuation voltage due to limitations in high-voltage power electronics and potential safety concerns. The required voltage input for actuation can be decreased by improving the properties of the dielectric materials (ϵ_r) or by reducing the thickness of the dielectric layers. For example, prestretching the solid dielectric material layers is a common technique to improve the actuator's performance (22). However, this improvement introduces rigid components into otherwise fully soft robots.

2.2.2. Hydraulically amplified electrostatic actuators. Electrostatic actuation with hydraulic amplification is another type of electrostatic actuation that couples electrostatic and hydraulic forces together to achieve muscle-like performance (24). In general, the actuator units of these soft robots are created by partially covering both sides of an elastomeric deformable shell with conductive ink that acts as electrodes. The shell is then filled with liquid dielectric materials, such as oils. The presence of liquid dielectric materials between the opposing electrodes generates local hydraulic pressure inside the actuator upon electrical stimulation in the kilovolt range (**Figure 1b**, subpanel *ii*). Unlike DEAs, the generated hydraulic pressure, coupled with Maxwell stress, advantageously causes the actuators to deform extensively. Another potential advantage of using liquid dielectric materials in a hydraulically amplified design is that the actuator is able to immediately recover from dielectric breakdown events if a suitable material system is used (25).

Several hydraulically amplified electrostatic actuator designs have been reported in the literature. Donut-shaped hydraulically amplified self-healing elastomer (HASEL) actuator designs present a pull-in transition when they are actuated and appear in a toroid shape. Similar planar designs present in-plane expansion when they are actuated, and their operation principle resembles that of DEAs (24). Peano-HASEL actuator designs are a series of rectangular pouches and present in-plane contraction when they are actuated (26). Another type of actuator that works at much lower voltages is hydraulically amplified zipping electrostatic actuators for haptics (27); liquid-amplified zipping actuators for micro-aerial vehicles (28) work on a similar principle. Although most of these actuators are created by using molding (24) and heat-sealing (26) methods, 3D multimaterial printing platforms can also be used to fabricate them (29).

2.2.3. Ionic polymer–metal composite actuators. Ionic polymer–metal composite (IPMC) actuation is used to manufacture soft electrochemical actuators that are composed of an ion-conducting polyelectrolyte layer sandwiched between two parallel-aligned flexible opposing electrodes. Unlike electrostatic actuators, such as DEAs and hydraulically amplified electrostatic actuators, IPMC actuators work at low stimulation voltages, from 1 to 5 V (30). Inside the polyelectrolyte layer are polymers with a carbon backbone that stabilize the negatively charged ions (anions) at their positions, and the positively charged ions (cations) can freely move inside the polymer network. When an electric field is applied to the electrodes, the free cations migrate toward the cathode and cause a swelling effect around the cathode (**Figure 1c**). This swelling effect, which is due to the inhomogeneous distribution of ions inside the polyelectrolyte layer during electrical stimulation, creates a stress gradient and causes the actuators to deform (31).

IPMC actuators respond more slowly to the applied electric fields than DEAs and HASEL actuators, since their deformation is dependent on the migration speed of cations toward the cathode. In addition, the water content of the polyelectrolyte layer is of paramount importance in the actuators' performance, and most of these actuators can therefore only work in moist environments or underwater. Finally, IPMC actuators can be fabricated using different techniques, such as hot pressing (32), sputtering, or electroless plating (33).

2.3. Thermal Actuation

Shape-memory alloys (SMAs) are the most commonly used temperature-responsive metallic composite materials in artificial muscles for soft robots. These materials present two essential characteristics: the shape-memory effect and the superelastic effect (34). The shape-memory effect arises when SMAs are heated above their transformation temperature; due to this effect, even if the SMAs are permanently deformed at low temperatures, they return to their original (pre-deformed) states when they reach a temperature that is higher than their transformation temperature. SMAs can exist in two different phases and demonstrate different shape-memory effects, the most common of which are one-way shape memory and two-way shape memory. Once returned to their original states, one-way SMAs cannot return to their previous deformed states when the temperature decreases below their transformation temperatures. However, depending on their surrounding temperatures, two-way SMAs can exist in their deformed (cold) and pre-deformed (heated) states. Although the superelastic effect seems to demonstrate behavior similar to the shape-memory effect, it represents the isothermal recovery of SMAs above their transformation temperatures following a mechanical loading and unloading cycle.

In soft robotics, SMAs are used as structural elements for actuation inside robots' elastomeric matrices. These materials deform and thus actuate soft robots due to their shape changes, which are induced by Joule heating (**Figure 1d**). Some SMAs can deform by up to 8% when they are in a straight shape; however, when they are designed in a spiral shape, their deformation can

exceed 300% (35). Due to the necessity of electrical stimulation, most SMA-based soft robots that have been reported in the literature are tethered (36), and they operate underwater to enhance actuation speed and performance by increasing the cooling rate of SMAs (37, 38). However, high-performance thermal robots that are actuated with SMAs can be manufactured with thermoconductive elastomers. These elastomers make the SMAs cool down and return to their natural states more quickly (39).

The major drawback of SMAs is their reliance on temperature changes for actuation, which decreases their energy efficiencies. Their bandwidth is also limited by the thermal cycle, so mechanical fatigue can occur following a few actuation cycles. Moreover, these materials present nonlinearity and wide hysteresis, both of which cause control difficulties. On the other hand, they have a high work density, can deform under low voltage stimulation, and operate cleanly and silently, which decreases the adverse effects of toxic degradation products and constant noise on living beings both underwater and on land. SMA actuators can be fabricated in a similar way to fluidic actuators, but their active components are pre-deformed SMAs rather than internal inflatable cavities.

2.4. Magnetic Actuation

Magnetic actuation commonly arises from the spatiotemporal alignment of magnetic materials (which are trapped in soft, deformable structures) under the influence of external magnetic fields (40). This actuation principle allows for the creation of untethered, compliant soft robots that can potentially perform safe operations inside delicate unstructured environments, such as the brain and inner body cavities (41, 42). Soft robots that use this actuation modality are composed mainly of microscopic ferromagnetic materials that are integrated into soft elastomeric matrices. The spatial alignment of the magnetic domains of hard ferromagnets during the fabrication process is the key to achieving the desired soft body deformation and motion (43, 44) (**Figure 1e**). The magnetic domains of materials can be aligned by first molding magnetic pre-polymer solutions into pre-defined complex structures and then applying strong external magnetic fields above their magnetic saturation points (12, 45). Alternatively, one can directly align the magnetic domains using external magnets while 3D printing a soft robot (46, 47). Moreover, the domains of magnetic materials can be reprogrammed even after fabrication by first erasing the magnetic memory of materials through heating above their Curie temperatures (48, 49) and then remagnetizing according to the new desired domain arrangements.

The safe penetration of magnetic fields into the human body is one of the main advantages of this actuation modality. This property allows the development of compliant robots that operate inside the human body in an untethered fashion. However, setups with electromagnets or permanent magnets generate inhomogeneous magnetic fields that complicate the control of these soft robots. In addition, even though these robots are untethered, large stationary electromagnetic setups are needed for their powering and control. The necessity for such large and complex setups that can produce homogeneous magnetic fields in a tiny volume limits the scaling up of magnetic soft robots. Finally, controlling these magnetic robots becomes difficult when there are metals in close proximity, as the robots are attracted to them. Therefore, their application has been concentrated mainly in endoluminal procedures.

2.5. Biohybrid Actuation

Integrating the advanced functions of cells into soft robots could allow us to leverage the performance and features of living materials. In soft robotics, biohybrid actuation can be achieved by integrating contractile eukaryotic cells, such as skeletal muscle cells and cardiomyocytes, into soft

robot designs (50). These cells are intrinsically soft and compliant, and when they are combined with biodegradable materials, they provide an eco-compatible and sustainable source of engineering materials to build soft robots (51). Soft robots that are made of living materials also carry their own fuel source (nutrients in the surrounding medium) and display a higher power-to-weight ratio than other actuation technologies (52). Moreover, living cells can proliferate to reconstitute lost parts of their assemblies, and therefore, soft robots that are built with living materials possess efficient self-healing functions (53).

Contractile cells of either mammalian (54) or nonmammalian (55) origin can be used to create biohybrid soft robots. These soft robots can be fabricated by directly extracting functional contractile tissue from living organisms, known as the top-down approach, or by engineering tissues in cell culture with primary cells or cell lines, known as the bottom-up approach (50).

2.5.1. Mammalian origin. Primary cardiomyocytes and skeletal muscle cells are the most commonly used cell types of mammalian origin for biohybrid actuation. Cardiomyocytes are widely extracted from neonatal organisms and then are functionally integrated into soft, deformable materials to create thin-film soft robots (56–58). However, their involuntary contraction drastically limits the controllability of biohybrid soft robots. To overcome this shortcoming, genetic engineering strategies (i.e., optogenetic engineering) have been used to control the contraction of these cells via light stimulation (59, 60).

Unlike adult cardiomyocytes, skeletal muscle cells easily grow into 3D assemblies on a sub-millimeter scale. This property of skeletal muscle cells allows for the fabrication of 3D biohybrid actuator components rather than 2.5D thin films (61, 62). In addition, skeletal muscle cells contract only when they are excited by an external stimulus, which eliminates the control issues that arise from cardiomyocytes. However, the restrictive requirement of electrical stimuli to generate contractile forces for locomotion caused researchers to engineer optogenetic skeletal muscle cells to power the robots with external light pulses (63). Skeletal muscle-based soft robots can even locomote when optogenetically engineered nerve cells are integrated into the robot's body (64). However, the low incorporation efficiency of nerves with muscle bundles complicates the fabrication of nerve-controlled muscle-based soft robots.

2.5.2. Nonmammalian origin. Self-contractile tissues of nonmammalian origin, such as frog tissue (65) and insect tissue (66), can also be used to fabricate robust biohybrid soft robots. These tissues can tolerate a wide range of environmental fluctuations and can survive in extreme pH levels and temperature conditions without losing their contractility and function (67). In addition, soft robots that are built with these tissues can operate at an ambient temperature without any additional carbon dioxide and oxygen supply. Compared with mammalian tissue, the use of non-mammalian tissues in biohybrid soft robots is advantageous for the translation of biohybrid soft robots to real-world conditions. However, because most of these tissues still need to be directly extracted from living animals, this fabrication approach raises ethical issues (50).

3. MODELING AND SIMULATION

Conventional modeling and simulation solutions for traditional rigid-bodied robots do not fulfill the requirements to characterize soft robots' behavior. Therefore, we need modeling and simulation solutions that have been specifically developed to accurately represent soft materials' responses to external stimuli. This section introduces different methods that are used to model and simulate soft robots, with the goal of applying them to the optimization and control of soft robots. **Figure 2** provides an overview of the methods for modeling soft robots.

3.1. Numerical Mesh-Based Modeling

In soft robotics, the most accurate modeling approach is based on simulating the continuum mechanics that govern the robots' deformation due to internal and external forces during actuation. In the numerical mesh-based modeling approach, soft robots are defined by their material properties, such as Young's modulus and Poisson's ratio, and the representation of their geometry. In general, soft robots' geometry is discretized with a mesh of simple shapes known as elements. Examples include triangles/rectangles and tetrahedrons/hexahedrons in 2D and 3D spaces, respectively (71–73). Other shapes, such as regular uniform grids or particles, can also be applied to represent the robots' geometry (74). The discretization of the robots' geometry also allows the equations to be discretized for every element and solved numerically. A sufficiently fine mesh is essential for accurately representing soft robots' behaviors in a simulation framework based on a finite element method (FEM). In this regard, the Simulation Open Framework Architecture (SOFA) (75) has been successfully applied to model different soft robots (68, 71, 76). Due to its

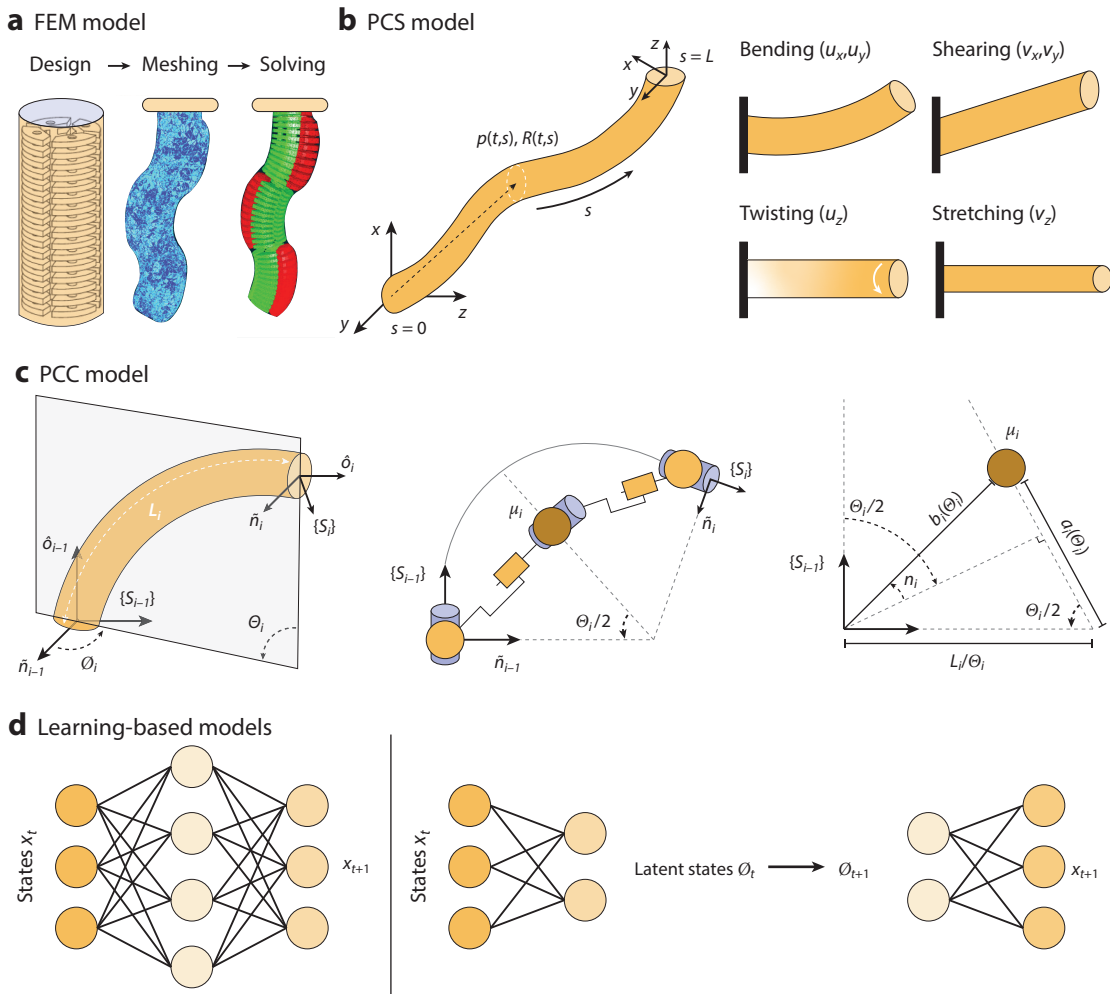

(Caption appears on following page)

Figure 2 (Figure appears on preceding page)

An overview of the modeling strategies used in soft robotics. (a) A FEM simulation based on numerical mesh-based modeling. In this type of simulation, soft robots are defined by their material properties and represented by meshes before solving the underlying, discretized physical equations. The FEM model shown here is of a soft continuum arm with selectively pressurized cavities. Panel adapted from Reference 68 with permission from IEEE. (b) A PCS model based on the Cosserat rod theory, which represents the deformation as a series of rods and can be used to model different deformation states of soft robots. The PCS model has four modes of deformation: bending, twisting, stretching, and shearing. In this panel, s describes the position along the Cosserat rod (going from 0 to L), and t describes time. At any point on the rod at any given time, we can describe its deformation using a frame represented by a translation $p(t, s)$ and a rotation $R(t, s)$. We can apply different external loads, such as torques in the x and y direction (u_x, u_y) or forces in the x and y direction (v_x, v_y), causing bending or shearing, respectively, or torques in the z direction (u_z) or forces in the z direction (v_z), causing twisting or stretching, respectively. Panel adapted from Reference 69 with permission from IEEE. (c) A PCC model, which is a further simplification of the PCS model that explains only the bending behaviors of soft robots. The middle subpanel depicts an augmented rigid arm model, which is used to compute the PCC dynamics. The right subpanel describes the geometry for computing the position of the center of mass for the augmented rigid arm model. Every segment i has a local frame S_i , a length L_i , an angle of curvature Θ_i , and an orientation Φ_i of the curvature plane with respect to the plane described by \tilde{n}_{i-1} and $\tilde{\delta}_{i-1}$; the center of mass μ_i has a distance to origin b_i and a distance to the center of curvature a_i . Panel adapted from Reference 70 with permission from IEEE. (d) Learning-based models that predict the dynamic behavior of (often) nonlinear systems either in the original state space or in a latent/hidden representation of the states. Depending on the objective, this latent space can be low-dimensional if we want to reduce the complexity of the input to only its core information (similar to reduced-order modeling), or it can be high-dimensional if we want to linearize the dynamics, as seen in the Koopman operator. The design of the latent space is a trade-off between the complexity of the dynamics and the complexity of the state. Abbreviations: FEM, finite element method; PCC, piecewise constant curvature; PCS, piecewise constant strain.

open-source nature, it has gained popularity in the soft robotics community over other traditional FEM frameworks, such as COMSOL Multiphysics (77) and Abaqus (78).

It is crucial to model how soft robots interact with their surroundings using a simulation framework that includes contact dynamics. To this end, several efficient and accurate time-stepping methods for elastodynamics have been proposed for soft body collisions (73, 79). These methods solve the dynamic equations using constraints that represent the collisions. Whereas Incremental Potential Contact (IPC) solves the constrained minimization problem for the dynamic equations that use a contact-aware Newton-type solver (73), others have approached the task by directly solving the mixed linear complementarity problem, which arises from the constrained optimization (79). These results were originally introduced in the computer graphics field, but applying them to modeling extreme deformations in real-world scenarios shows promise in the applicability of this method to soft robotics.

In recent years, it has also been desirable to use differentiable frameworks for simulation. These frameworks allow us to obtain the gradients of an objective (e.g., how high a soft robot can jump in 10 seconds of simulation) with respect to input variables, such as the control signal or length/height of the robot. Differentiable Projective Dynamics (DiffPD) provides an efficient simulation framework, based on projective dynamics, whereby nonlinear internal forces are approximated by quadratic energy terms (72). This approximation allows the solver to precompute part of its solution, which speeds up the process compared with FEM frameworks. DiffPD has shown its control and design co-optimization capabilities in the context of simulated underwater swimmers (DiffAqua) (80). DiffAqua uses simplified hydrodynamics in simulations, which only coarsely model fluid flow for real-world scenarios. Thus, a fast multiphysical simulation framework with fully simulated solid and fluid dynamics will eventually render these methods more practical. Since full numerical fluid simulations are prohibitively computationally expensive, an initial step toward this multiphysical system has been taken by using a deep learning surrogate model for fluids in combination with fluid–structure interaction (81).

ChainQueen is another approach to simulating deformable materials using a material point method that ensures differentiability and physical accuracy in real-world experiments (74).

Particle-based simulation frameworks are often used in computer graphics because they are extremely efficient, but they lack physical accuracy. The material point method combines the efficiency of particle-based methods with grid/FEM-based accuracy by projecting between the particle and grid (and vice versa) to apply forces onto the particles and solve the equations on the grid. This latter step is achieved by aggregating values from the particles to fixed grid nodes.

Unfortunately, transferring dynamics from simulation to reality is often not accurate. This inaccuracy can be referred to as a sim-to-real gap, and it has been analyzed for a few soft structures in DiffPD (82, 83). This sim-to-real gap must be closed to achieve accurate physical models and optimize the control and design of soft robots.

Full FEM simulations are, in practice, feasible only for simple soft robots, i.e., meshes with less than approximately 1,000 elements. The control and optimization of more complex structures are often computationally too expensive to simulate. Therefore, we need to simplify complex FEM simulations. One approach that builds on FEM is reduced-order modeling (68) (**Figure 2a**). Reduced-order modeling, in essence, truncates the state by orthogonally decomposing the state trajectory data from a snapshot experiment. In this snapshot, the states that best describe the motion are kept, which limits the generalizability of reduced-order modeling to how the experiment is defined.

3.2. Simplified Parameterization of Deformation

Further simplifications are often dependent on the morphology of soft robots. A Cosserat rod model is a type of deformation model that considers bending, twisting, shearing, and stretching for discrete line segments along the continuum soft body (84–87) (**Figure 2b**). Thus, a kinematic deformation model of a Cosserat rod model can also be referred to as a piecewise constant strain (PCS) model. As the term Cosserat rod model suggests, soft structures are approximated using long cylindrical segments or rods. The continuum mechanics for these segments or rods can be simplified since their symmetries are known; hence, the accuracy of this model depends greatly on the soft robotic shape in question. The PCS model can be simplified even further by considering only the bending of each segment. Piecewise constant curvature (PCC) (70, 88) (**Figure 2c**) is one of the simplest models used to model continuum soft robots. It assumes that, within each discrete segment along the continuous body, the bending curvature is constant and can be described by two parameters. Although PCC and PCS are sometimes introduced as opposing concepts, the PCC model can, in fact, be considered a subset of the deformation modes of the PCS model used by the Cosserat rod theory. The user decides how to separate the whole length of the robot into discrete PCC sections, but, in many cases, a single PCC section is assigned to each actuated segment (70, 89, 90). This assignment has the benefit that the model is fully actuated, enabling trajectory tracking in a configuration space (70, 89, 90). However, a finer discretization of the PCC sections may improve model accuracy (91).

Other deformation models are also used to understand soft robots' behavior. For instance, a modeling framework for continuum soft arms based on spline interpolation between nodes allows the modeling of static forces, such as elasticity, gravity, and actuation forces (92). In addition, polynomial curvature models (93) and Pythagorean hodograph curves (94) are used to simulate bending in soft robotic arms. The aforementioned deformation models have various degrees of fidelity. It should be noted that the choice of parameterization for deformation is usually a means to an end—the most important aspect of a soft robot's performance is how accurately it can be controlled, and this depends on not only the deformation model but also the controller framework. Thus, it is important to choose a model that sufficiently describes the movement of the designated robot design. For example, the soft continuum proprioceptive arm (SoPrA) is a manipulator that contains an inextensible fabric along its center axis, which limits its ability to stretch and shear;

therefore, the PCC model can be applied (91). In other cases, it may be advisable to also add a stretching deformation mode to the model. Even if a simpler model is less accurate, its inaccuracy can be compensated for by using an effective feedback or adaptive controller (95).

3.3. Learning-Based Modeling

Unlike conventional modeling strategies, machine learning methods can also be used to represent soft robots (**Figure 2d**). For instance, neural networks can be trained in a supervised manner by using experimental data to accurately understand the dynamics of soft robots in a simulation environment. In most cases, the state space of soft robots is rather low-dimensional (e.g., bending angles or motion marker locations) (96, 97). In an extreme case, we could use high-dimensional FEM simulation data to train a neural network (98), which could then be used during the testing phase as a black-box forward model for fast inference. However, this is a computationally expensive approach, and although it shows potential for modeling structural deformations, such a method has not yet been applied to soft robots in practice. Furthermore, these supervised methods cannot be generalized to unknown scenarios, since they must be supervised and require new data to be collected from scratch after every significant modification in the soft robot's design. On the other hand, this efficient forward method can be applied to the closed-loop control of soft robots (96), and it performs impressively when it is combined with model predictive control (MPC) (97).

A low-dimensional representation for a soft continuum arm's dynamics has also been discovered with an autoencoder neural network architecture. Soter et al. (99) trained this architecture by using the soft robot's movement data, which were acquired with an RGB camera. In this work, the authors used a latent representation to generate a map between a proprioceptive bend sensor's data and the low-dimensional representation of the robot. Eventually, it was possible to reconstruct the robot's motion by using only the sensor's data. This work demonstrates that the complex dynamics of soft robots can be modeled in a simple state space by using these encoding techniques.

Finally, the dynamics of soft robots can also be modeled with dynamic mode decomposition using the Koopman operator (100). This method involves linearizing the nonlinear system dynamics of soft robots in a high-dimensional latent state space so that the linear dynamics can be used for control strategies. This concept has been extended to model and control stochastic system dynamics using a deep stochastic Koopman operator (DeSKO) (101) with a stability-assured control method for soft robots.

4. CONTROL STRATEGIES

Like modeling, the control of soft robots is challenging due to their continuum nature. Conventional control schemes that are used for controlling rigid-bodied robots cannot be directly applied to soft robots because they assume that discrete joints are located along a chain of rigid links. Therefore, we need precise controllers that have been developed specifically for dynamic soft robots with their high DOFs. **Figure 3** provides an overview of the methods for controlling soft robots.

4.1. Model-Based Control

In this control approach, a model is first created with a priori knowledge about the structure of soft robots; then, the model is used to formulate a controller. This class of controllers contrasts with data-driven control approaches, which generate appropriate control policies directly from actual motion data. Because model-based control has been extensively researched in conventional rigid-bodied robotics (103), there are several existing controller architectures that can be applied to soft

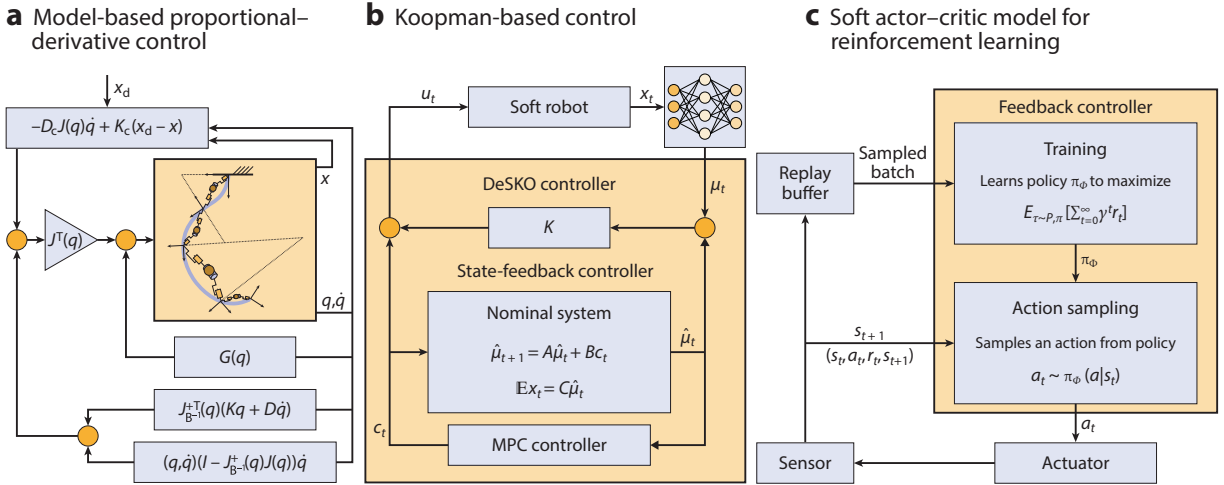

Figure 3

An overview of the control strategies used in soft robotics. (a) Model-based proportional–derivative control of a soft continuum arm in a task space. This approach enables Cartesian impedance control to the desired end-effector position x_d by attaching a virtual spring and damper (with stiffness K_c and damping D_c) to the end effector. Panel adapted from Reference 90 with permission from SAGE Publications. (b) Koopman-based control using the DeSKO model. The nonlinear dynamics can be described by a linear model using the Koopman operator K , enabling linear control methods to be applied. Panel adapted with permission from Reference 101. (c) An adapted soft actor–critic model for reinforcement learning on soft robots. The controller learns a policy π_ϕ to maximize the objective function. This policy is based on the robot’s history of state s , action a , and reward r . Panel adapted from Reference 102 with permission from IEEE. Abbreviations: DeSKO, deep stochastic Koopman operator; MPC, model predictive control.

robotics. However, these architectures need some modifications due to the particular properties of soft robots, which complicate their direct application.

The first example of these modifications is that soft robots are composed of compliant materials that are not assumed in conventional models and controllers for rigid-bodied robots. Therefore, additional elements, such as linear (70) or nonlinear (104) elasticity, must be introduced to address the compliant nature of soft robots. Furthermore, soft robots have infinite DOFs due to their continuous deformation capability, and this capability must be approximated with discrete models, such as the PCC (70) or PCS (84) model. Depending on the discretization of the deformation model, the configuration space can have more DOFs than the number of actuators, making them underactuated systems. In this case, underactuated control techniques, such as optimal control, must be used to generate control inputs. In addition, the actuation space of soft robots is usually force based (e.g., air pressure for fluidic actuation, or voltage input for electrostatic actuation) rather than position based. Whereas low-level firmware for rigid robots often accepts joint position as input from the state of the controller, the control signal for soft robots must typically be sent in the force space.

4.1.1. Kinematic model-based control. Kinematic model-based control considers the posture of soft robots without any force. Therefore, this approach only requires a simple model, and it can perform only position-based or velocity/acceleration-based control. This property makes it less effective for interactive tasks, such as manipulation. Nonetheless, it is effective at achieving demonstrative behaviors; for example, a kinematics-based controller that uses a simplified Jacobian has been used to control the tip position of a soft continuum arm and applied to tasks such as opening doors and performing stick-shift operations (105). This observation suggests that, for

soft robots, a relatively simple kinematics-only low-level controller, paired with an effective high-level planner that defines the specific task, can be as performant as controllers that are based on complex models. Inverse kinematics, which is the process of calculating the pose that is required to achieve a certain task (e.g., the tip position), presents additional challenges for soft robots with high DOFs (although a closed-form solution can be found in some limited cases) (106).

4.1.2. Dynamic model-based control. Dynamic model-based control considers the dynamics of soft robots; it starts with creating a manipulator equation (i.e., the equation of motion for a link chain) and proceeds by applying a controller based on this equation. This control approach considers physical forces such as inertia or gravity, and thus, it can achieve more accurate control than its kinematic counterparts, and it is more versatile in achieving force-based interactions with a robot's surroundings.

In the augmented rigid body model approach, the manipulator equation is calculated by using a rigid link model that emulates the structure of soft robots (70, 89–91). This augmented rigid body model is a virtual link structure that matches the kinematic structure of the PCC model at both ends of the PCC section. It also matches the center of mass's position, thereby approximating the dynamic properties of soft robots. The dynamics of this model can be computed with standard robotics libraries and then converted to a robot's configuration space. This strategy has been applied to dynamic feedback control for soft robotic arms in 2D (89, 90) and 3D (70) configurations (**Figure 3a**). Lagrangian dynamics can also be used to obtain the dynamics of the manipulator. In this method, the potential energy V and kinetic energy T of soft robots are computed analytically, after which the Lagrangian $L = T - V$ is used in the Lagrangian equation of motion. This strategy results in a more computationally efficient calculation of the dynamics compared with the augmented rigid body method (95).

Rather than focusing on improving the trajectory accuracy of soft robots in isolated experimental environments, recent research on dynamic model-based soft robotic control has started to focus on applications to real-world tasks for soft robots by incorporating concepts that were developed for rigid arm control. Operational space control is an area of research in which classic robot control has recently been applied to soft robots. Operational space control is important for robots to achieve specific tasks, and it has been researched from both a theoretical (107) and practical (108, 109) perspective. For example, it has been shown that even underactuated systems that have an actuation space with the same DOFs as the task can achieve operational space control (107). Recently, a soft arm was able to achieve practical and dynamic movements, such as drawing and throwing, by using operational space control (109).

It is often difficult to obtain an accurate model parameter value for soft robots due to their nonlinear material properties or unexpected deformations, which occur due to environmental interactions. Therefore, adaptive control is another area of research in which classic robotic concepts have been applied to soft robots. Adaptive controllers based on the dynamics model from Lagrangian dynamics (95) and the augmented rigid body model (110) have been proposed for soft robots. Controllers that exploit a priori knowledge about the uncertainty of robots' movements and adapt to specific changes, such as adapting to orientation errors, have also been proposed (111).

4.2. Data-Driven Control

The model-based control approaches that were introduced in the previous section use a priori knowledge about a robot's structure to construct an analytical model. By contrast, data-driven control approaches use motion data from an actual robot's movement or its simulated model to train the controller. Data-driven control can be effective at capturing individual differences in, or

the nonlinear properties of, soft robots that are hard to model analytically, although data must be collected for training.

The Koopman operator linearizes the nonlinear dynamics of soft robots for modeling and simulation. It can also be used to successfully apply linear control theory to nonlinear systems (100). For example, the use of robust MPC with a Koopman operator enhances soft robots' performance and stability against disturbances (101) (**Figure 3b**). Learned models have also been used in combination with classic MPC for soft continuum arms (96). The MPC is based on a dynamic model, learned from motor babbling, and it enables a soft arm to reach statically unreachable poses by swinging upward, greatly increasing its workspace.

As a counterpart to traditional control methods, reinforcement learning has also been applied to a fluidic soft arm for position control (112) (**Figure 3c**). Deep Q-learning, which is a model-free reinforcement learning approach, is used for controlling this soft arm. The reinforcement learning agent is trained in simulation using the Cosserat rod theory for the model, and then the learned position control policy is applied to the soft arm. The control policy is robust against external disturbances such as loading, even though no external loads were applied during training. A powerful reinforcement learning framework has been created by using a modified version of soft actor-critic (102). This framework has been fully trained on experimental data, and it can be applied to the position control of a complex soft robot actuated by vibrations and pneumatics.

5. SENSING STRATEGIES AND SENSOR TECHNOLOGIES

The sensorization of soft robots is a long-standing challenge that must be overcome to complete autonomous tasks. Since most conventional sensors have been designed for rigid structures, they are difficult to integrate into the compliant, flexible bodies of soft robots. Soft robots theoretically have infinite DOFs, so sensors for measuring their continuous posture changes must have sufficient motion range, accuracy, and resolution. Such sensors, when combined with a priori knowledge, can then properly reconstruct the soft robots' overall structure. In this section, we first discuss the sensing strategies (i.e., proprioception and tactile sensing) that can be applied to soft robots to strengthen their modeling, control, and safety. We then examine the available sensor technologies that can be used for proprioceptive and tactile sensing (**Figure 4**).

5.1. Proprioception

Proprioception is the sense of self-movement and body position. In soft robotics, proprioception provides information about the current state of a soft robot, which is crucial for proper feedback control. Motion capture systems are often used to measure soft robots' posture, especially in research works that deal with modeling and control (70, 90, 95, 96, 100, 101). In this method, reflective markers are placed along soft robots' bodies and detected by infrared cameras, enabling real-time ground-truth measurements of robots' posture. However, this method requires an external motion capture setup and does not work under occlusion, limiting its applicability to interactive tasks in the real world. For these reasons, various efforts have been made to embed soft robots with internal proprioceptive sensors so that their posture can be measured without motion capture systems (91, 113).

5.2. Tactile Sensing

While proprioception refers to being aware of one's own movement, tactile sensing involves gathering information about the external environment through the sense of touch. One of the advantages of soft robots is their ability to conduct compliant interactions with the environment,

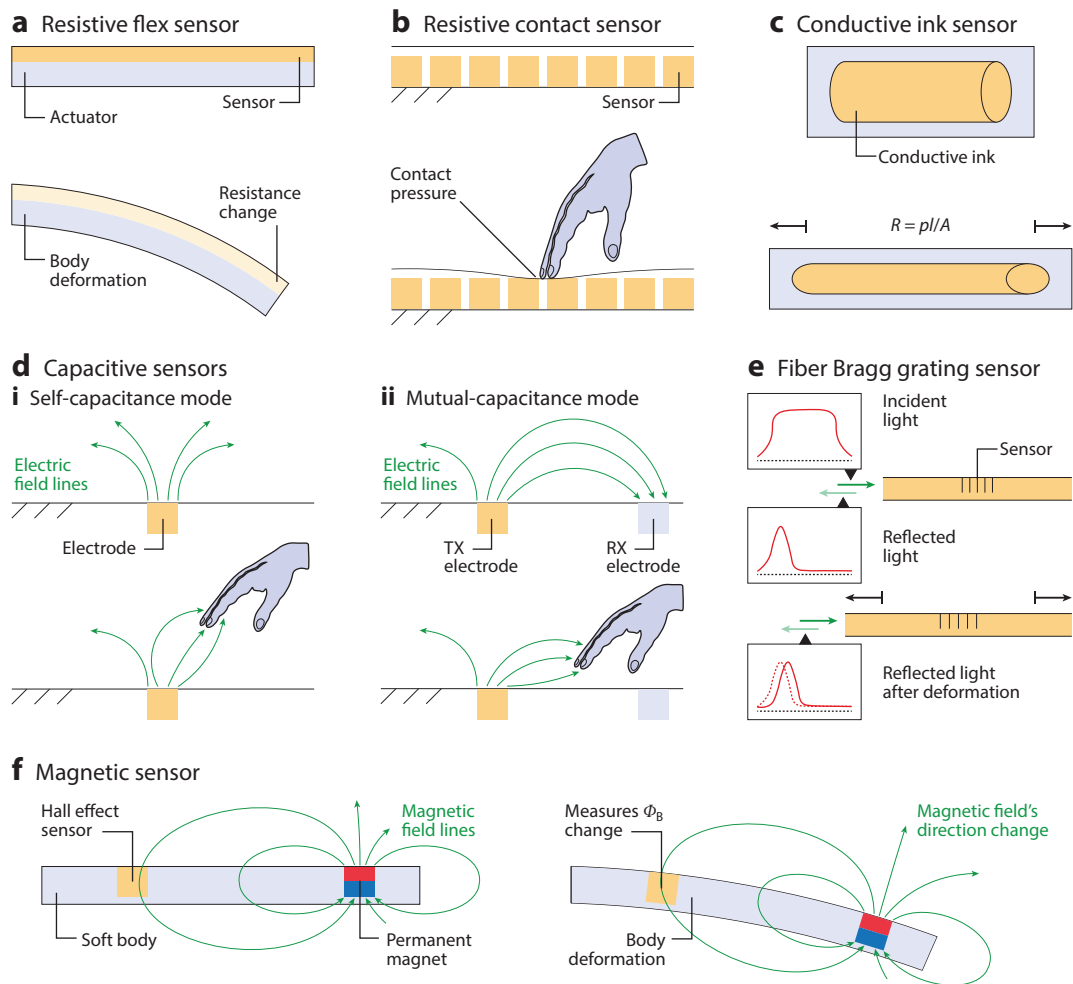

Figure 4

An overview of the sensor technologies used in soft robotics. (a) A resistive flex sensor, which detects soft robots' deformation states through changes in their resistance due to bending. (b) A resistive contact sensor, which detects the physical interaction of soft robots with their surroundings through changes in their resistance due to force and pressure. (c) A conductive ink sensor, which detects soft robots' deformation state through changes in their resistance due to stretching. The amount of stretch that conductive ink sensors are subject to can be measured using Pouillet's law, which correlates the resistivity with the cross-sectional area and length of the resistive material. (d) Capacitive sensors, which detect the interaction of soft robots with their surroundings through changes in their generated electric fields. When an object approaches a capacitive sensor in self-capacitance mode (subpanel *i*), it drains the generated electric field by the sensor; when an object approaches a capacitive sensor in mutual-capacitance mode (subpanel *ii*), the shielding effect reduces the electric field that is received by the RX electrode. (e) A fiber Bragg grating sensor, which detects soft robots' deformation state through changes in the spectrum profile of the reflected light within the optical fiber. (f) A magnetic sensor based on the Hall effect. This sensor detects soft robots' deformation state by measuring magnetic flux changes arising from the displacement of a permanent magnet. Abbreviations: RX, receiver; TX, transmitter.

so it is crucial for a soft robot to be able to sense when it comes into contact with something. Methods to sense contact include resistive sensors (114), capacitive sensors (113, 115), and magnetic sensors (116). Most of these technologies require an array of sensors, which are placed across a robot's surface, to gather detailed contact sensing data. Another method that has been recently

developed uses a camera inside a bubble gripper with a textured internal surface. This method allows the gripper's deformation, which is caused by contact, to be observed (117).

5.3. Sensor Technologies

Different sensor technologies can be used to enable previously described proprioceptive and tactile sensing abilities in soft robotics. These sensor technologies have different performance metrics in object detection, deformation type, nonlinearity, and hysteresis. Therefore, evaluating these metrics and choosing the most appropriate sensor technology for the envisioned soft robot's design is crucial.

5.3.1. Resistive and piezoresistive sensors. The resistance of elastic conductive materials changes depending on their deformation states. The correlation between the changes in the resistance and the deformation state of these materials allows soft robots' actuation states to be identified. This technology allows soft robots to gain information about their surroundings through contact-based interactions (**Figure 4a**). These sensor technologies offer low-cost solutions for proprioceptive soft robots (68, 118–120). However, their readout suffers from hysteresis, and therefore measurements of dynamic movements may not be accurate (119). 3D-printing technologies can be used to print resistive sensors together with soft robots' bodies, enabling an integrated sensor-actuator that allows for complex sensor placements (118, 121). Moreover, resistive sensors can be configured to detect contact instead of self-induced deformations (**Figure 4b**). Thus, a soft gripper with resistive flex and touch sensors is able to haptically identify objects that it is holding (114). Piezoresistive sensors work according to the piezoelectric effect; the materials' resistivity changes according to the applied strain or pressure. However, the nonlinear readouts and hysteresis properties of piezoresistive sensors require a trained recurrent neural network to convert the raw measurements into pose estimation results (122).

5.3.2. Conductive liquid sensors. Conductive liquids, such as liquid metals (123) or ionic liquids (124), can be used inside the internal deformable cavities of soft robots to measure changes in the resistance according to the soft robots' deformation states. Once these changes in the resistance have been measured, the robots' deformation states can be reconstructed using Pouillet's law (123) (**Figure 4c**). These sensors are prone to hysteresis, similar to resistive sensors. Nonetheless, complex sensor arrangements can be created by introducing channels for the conductive inks during the fabrication process (125), which increases the freedom for sensor placement. An optimization method can be used to generate the most effective sensor route to sense deformation and demonstrate its sensing capability on a physical sensing element (123).

5.3.3. Capacitive sensors. Capacitive sensors can be used to proprioceptively measure soft robots' poses and exteroceptively measure their contact with their surroundings. They can operate in two different modes for haptic sensing: self-capacitance mode and mutual-capacitance mode (113). The self-capacitance mode applies an alternating current to a single electrode and detects nearby objects that drain the generated electric fields (**Figure 4d**, subpanel *i*). The mutual-capacitance mode requires a pair of electrodes to send and receive signals; in this mode, an approaching conductive object causes a shielding effect, while physical contact that brings the electrodes closer together causes a coupling effect (113, 115) (**Figure 4d**, subpanel *ii*). It is difficult to detect nonconductive objects with capacitive sensors. However, the coupling effect for the mutual-capacitive mode depends on physical deformation and thus can potentially be used to sense nonconductive objects. A numerical optimization method has been used to merge measurements from capacitive and pressure sensors using a FEM model in the SOFA simulator to predict the position and magnitude of the contact force applied to soft robots (113).

5.3.4. Optical fiber sensors. Optical fiber sensors that are based on the fiber Bragg grating pattern are promising to measure the continuous deformation of soft robots. Inside these sensors, optical fibers are engraved with a regular pattern at the point of measurement that is designed to return a particular spectral frequency response (126). When the section with the grating is strained, the frequency response changes, making it possible to measure the strain at that point (**Figure 4e**). By introducing these patterns along the length of the fiber and bundling multiple fibers together, one can reconstruct the sensor array's continuous geometry. Different grating position and sensor placement configurations have been proposed for effectively sensing the continuous curvature, as well as several algorithms to reconstruct a soft robot's deformation states (127–130). The fibers are thin and require little space to be integrated into soft robots' bodies. However, the readout terminal that measures the frequency response tends to be bulky, prohibiting mobile applications.

Though fiber Bragg grating sensing systems are commercially available, the sensors and terminals are expensive for widespread application. However, the sensing element's thin form factor and the curvature readout's accuracy make them a viable solution for critical applications, such as minimally invasive surgery (130), when the high-cost and large-readout equipment can be afforded in return for better outcomes.

5.3.5. Magnetic sensors. Magnetic sensors use the Hall effect for sensing (**Figure 4f**). Unlike resistive sensors, magnetic sensors are low cost and not prone to hysteresis. For instance, a flexible printed circuit board with an integrated magnetic sensor and small magnet can be embedded in the neutral midplane of a planar soft robot; when the robot is flexed, the magnet moves relative to the sensor, resulting in a measurable change of magnetic field (119). Although these sensors offer hysteresis-free measurements and compact form factors, they are vulnerable to the external effects of metal or magnets, and they cross-talk with other nearby magnetic sensors unless they have been carefully shielded (131). Due to their precision and ability to work at a distance, catheters with magnetic sensing can be used to locate their tips *in vivo* and therefore reduce procedure times for patients (132, 133).

6. APPLICATION AREAS

Soft robots enable complex operations that require navigation in unstructured environments and safe interaction with delicate objects. They have already presented their potential in assisting search-and-rescue missions (134), exploring underwater habitats (135), manipulating fragile objects in industrial settings (136), and executing noninvasive medical operations (137). In this section, we examine different soft robots that are used for manipulation, exploration, or healthcare applications.

6.1. Manipulation

Most soft robots can leverage their natural softness and intrinsic compliance without extensive sensorization (to measure deformation, contact, or force) to manipulate fragile objects or interact with their surroundings. Manipulation with soft robots can be achieved in three distinct ways: by controlling actuation, adhesion, or stiffness (138) (**Figure 5a**). Most soft robotic actuation modalities can be applied to manipulate objects by controlling the actuation of soft robots (7, 24, 91, 145). However, when soft robots operate based on controlled adhesion, they should have special structural elements (e.g., gecko-inspired pillars) that can interact with the target object (146) or generate attractive physical forces (e.g., electroadhesion forces) between their surface and the target (139). Additionally, when soft robots manipulate objects by changing their stiffness, they can be fabricated using different actuation modalities and have different configurations. In this group

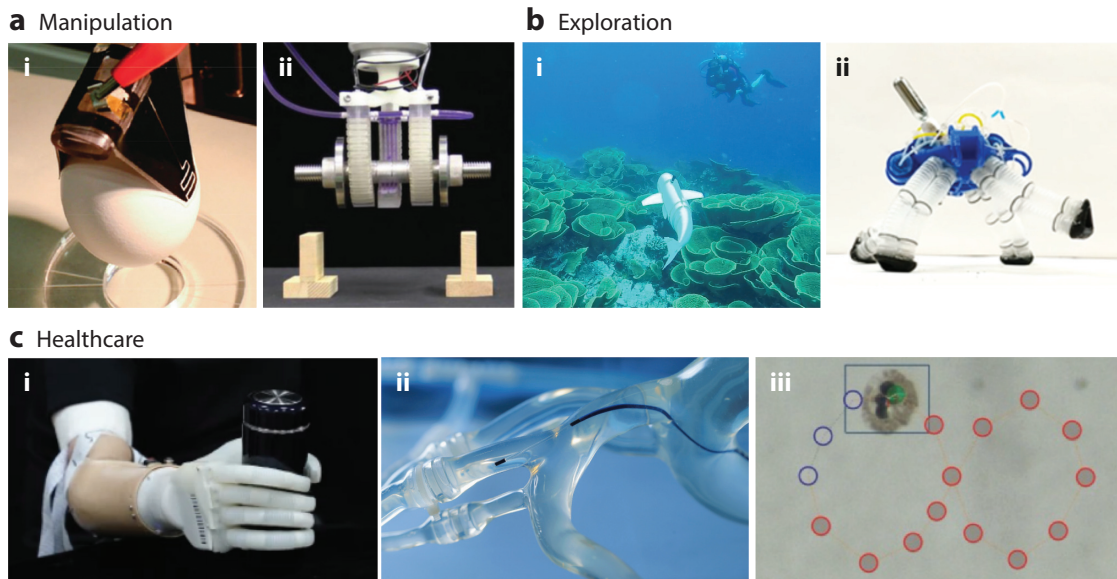

Figure 5

Common soft robotic applications. (*a*) Manipulation. Soft robots can be used to manipulate delicate objects due to their softness and compliance. In addition, their manipulation performance can be enhanced by strengthening their interaction with the target object. This improved interaction can be achieved by controlling their adhesion to the target object's surface (subpanel *i*) or by tuning their stiffness according to the target object's weight (subpanel *ii*). Subpanel *i* reproduced with permission from Reference 139; copyright 2015 John Wiley and Sons. Subpanel *ii* reproduced with permission from Reference 140; copyright 2019 John Wiley and Sons. (*b*) Exploration. Soft robots allow us to explore our world due to their ability to safely interact with their surroundings, both underwater (subpanel *i*) and on land (subpanel *ii*), without creating external stress on living beings. Subpanel *i* reproduced with permission from Reference 135; copyright 2018 The American Association for the Advancement of Science. Subpanel *ii* reproduced with permission from Reference 141; copyright 2021 The American Association for the Advancement of Science. (*c*) Healthcare. Soft robots can be successfully used in several different medical areas, including prosthetics (subpanel *i*), catheters (142) (subpanel *ii*), and drug delivery (subpanel *iii*), due to their mechanical resemblance to natural tissues and high-DOF operation capabilities. Subpanel *i* reproduced with permission from Reference 143; copyright 2021 Springer Nature. Subpanel *ii* reproduced with permission from Wyss Zurich (Project Nanoflex); copyright 2021 Wyss Zurich. Subpanel *iii* reproduced with permission from Reference 144; copyright 2021 John Wiley and Sons. Abbreviation: DOF, degree of freedom.

of soft robots, the ones that work with a jamming mechanism are the most promising for manipulating high-load objects with a minimal applied force (136). In general, soft robots have been used to gently manipulate delicate, lightweight objects. Nonetheless, most soft robots cannot manipulate heavy objects. This issue can be tackled by designing soft robots that can tune their stiffness according to the weights of their target objects (140). With this strategy, it is possible to enhance soft robots' performance and widen their application areas.

6.2. Exploration

Soft robots, especially ones that have bioinspired designs (135), facilitate the exploration of our world by monitoring or interacting with living beings in their surroundings. Their biomimicry allows them to reach and follow their living surveillance targets without causing them apparent stress or threatening them (135) (**Figure 5b**, subpanel *i*). In addition, these robots can be designed to camouflage themselves by changing their colors according to their surrounding environment (147, 148). Moreover, they can work under extreme environmental conditions, e.g., with large temperature variations (149, 150) or extreme pressures (151), without any structural modification.

Furthermore, their intrinsic compliance ensures that they can navigate with a limited control input in unpredictable environments (e.g., debris) during search-and-rescue missions (134). In general, the tethered nature of most soft robots limits their use for exploration applications. As a result, several research works have focused on creating soft robots that can be remotely operated (**Figure 5b**, subpanel *ii*). In this regard, batteries are often integrated into soft robots as an energy source (135). Apart from batteries, monopropellant fuels, which can be supplied through microfluidic logic gates, are also used to power these robots (152). Fuel cells served as energy storage and fluidic actuator media in a swimming soft robot (153).

6.3. Healthcare

The compliant nature of soft robots enables their use in several healthcare applications, including rehabilitation, minimally invasive surgery, and targeted drug delivery. In rehabilitation, soft robots provide safe cooperation with patients and assist them during recovery. Soft robots' inherent softness and compliance allow them to follow motion paths that are kinematically similar to humans'. Their softness also allows them to conform to patients' bodies and prevent the application of nonphysiological loads that could damage the musculoskeletal system during rehabilitation.

While soft robots have been developed for rehabilitation applications for most major joints of the body, most efforts have been devoted to restoring hand function. Soft hand devices are often shaped like gloves, supporting finger bending to execute rehabilitation exercises or assistive tasks (143) (**Figure 5c**, subpanel *i*). These gloves have been driven by different mechanisms, including fluidic, shape-memory, and electrostatic actuators.

In minimally invasive surgery, soft robots can improve the dexterity, flexibility, and maneuverability of surgical tools, thereby reducing the size and number of incisions that are required to perform an operation (**Figure 5c**, subpanel *ii*). In general, minimally invasive surgeries involve the use of two or three semirigid tools, assisted by a rigid endoscope for vision; however, the use of multiple access ports leads to challenges in tool encumbrance and triangulation. Soft robots can be introduced through a single incision or natural orifice and navigate around organs and anatomic structures to reach the surgical target site. Soft surgical robots that use various actuation mechanisms have been demonstrated in proof-of-concept studies, including fluidic (154), magnetic (142, 155), and shape-memory-driven (156) robots. These robots have also been applied to several *in vivo* models and in preclinical animal trials.

In drug delivery, soft robots can be used to deliver therapies to remote inner parts of the brain, liver, or pancreas by avoiding their accumulation in nontargeted body regions and decreasing their off-target distribution (144, 157). Reaching these regions requires navigating through the vasculature or hollow organs, which cannot be easily achieved with wired surgical tools. Soft robots can be small enough to deliver biological agents on demand in both tethered and untethered fashions. These soft robots are manipulated through external stimuli, such as magnetic fields, ultrasound, or temperature (**Figure 5c**, subpanel *iii*).

7. CONCLUSION AND FUTURE PERSPECTIVES

The great potential of soft robotics to revolutionize our daily lives is already becoming evident from the performance of the existing soft robots in delicate, unstructured environments. However, soft robots cannot yet fully replicate the complex functions that can be observed in nature, such as the smooth, high-DOF movement of an elephant trunk, the adaptation of cells to different environmental conditions, and the self-healing of tissues following an injury. Therefore, soft robots have not yet revealed their full potential to surpass the performance of existing rigid-bodied robots and to present the complex behaviors that can be seen in living beings.

a Dedicated controllers and stable interfaces

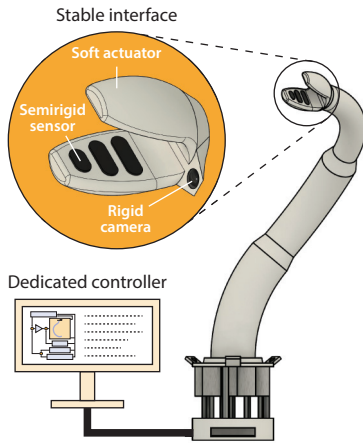

b Operation mode and lifetime

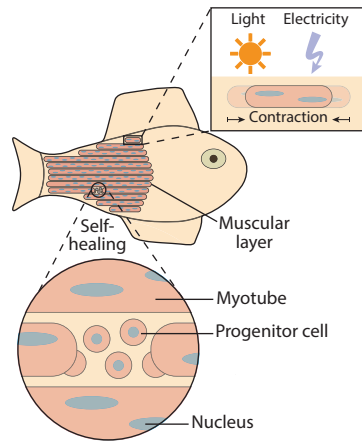

c Eco-friendliness and sustainability

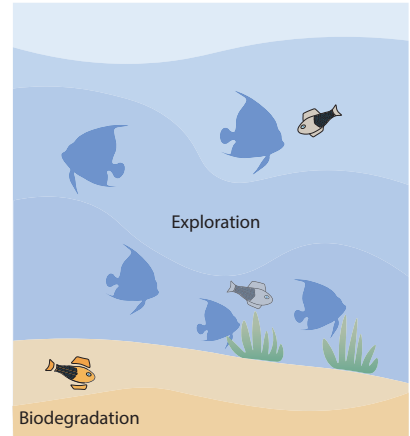

Figure 6

Potential areas of focus for future studies to increase understanding of the principles behind the design and operation of existing soft robots and tackle issues that limit their performance under real-world conditions. This figure highlights three key issues. (a) Dedicated controllers and stable interfaces. Soft robots' performance should be improved with new stable mechanical interfaces between the soft and rigid components and dedicated control architectures for precise human-robot interactions. (b) Operation mode and lifetime. The robots' operational lifetime should be enhanced by using, for example, self-healing, energy-efficient biological constructs; such constructs will need to be highly integrated and require new types of operation modes, such as optical or electrical cell stimulation. (c) Eco-friendliness and sustainability. Soft robots should be eco-friendly and operate in close proximity to living beings without creating a negative impact on them. The robots should also be degradable without leaving toxic by-products in the environment.

To advance soft robotics, future studies should focus more on understanding the principles behind the design and operation of the existing soft robots (158) and tackle the major issues that limit their performance and translation from laboratories to real-world conditions. In this regard, future soft robots' performance should be improved by developing special controllers and stable interfaces between their soft (e.g., actuators) and rigid (e.g., sensors) components (159). In addition, soft robots should be compact, integrated platforms, and their operational lifetime should be enhanced by using durable, self-healing, elastic materials as structural building elements (160). Only in this way can they compete with their rigid-bodied counterparts in a realistic work environment. Unlike traditional rigid-bodied robots, soft robots' entire structural components, including their electronics and powering units, should eventually be eco-friendly and made from sustainable materials to eliminate their negative impact on the environment (161) (**Figure 6**). In the following subsections, we discuss possible research efforts that can be made to tackle these major issues so that highly performant, integrated, and sustainable soft robots can be created in the future.

7.1. Dedicated Controllers and Stable Interfaces

The performance of existing soft robots can be significantly enhanced by developing dedicated power and control systems for them. Unlike traditional rigid-bodied robots, soft robots suffer from not having power controllers, models, or control architectures that have been customized for the actuation and sensing modalities that are needed to obtain and track the desired soft body deformation. Rather than continuously iterating the existing soft robots' actuator or sensor design to enhance their performance, future research efforts should try to concentrate on efficiently

powering these designs and modeling their dynamics and relevant multiphysics. Suitable and fast models can then be used to create specialized controllers and learning architectures. Soft robotics will move forward faster when these architectures have been developed specifically for soft robots, since this development will lead to more predictable and safer soft robots that are capable of reliably operating near living beings.

Interfacing between soft and rigid components is a trade-off that affects both the performance and the operational lifetime of soft robots. The added interfaces provide successful information and energy transfer between soft robots' components, such as actuators, controllers, sensors, and power units. Additionally, added rigid components strengthen soft robots' mechanical stability during actuation and operation. Unlike in traditional rigid-bodied robotics, there are no well-characterized, standardized, and stable interfaces in soft robotics that can be readily used to create soft robots. For this reason, it is not yet possible to systematically design and mass manufacture soft robots that can exceed the performance of both traditional rigid-bodied robots and living creatures. For instance, better interfacing would allow us to properly integrate sensors throughout soft robots' bodies for proprioception and tactile sensing. Dense proprioception and tactile sensing would lead to a more accurate perception of soft robots' deformation states, improved control, and smoother interaction with their surroundings. Such a capability would promote the safety of soft robots' interaction with their surroundings. As another example, stable interfacing would advance biohybrid soft robotics by increasing the performance of tissue-engineered muscle constructs (145). Tendon-like structures could be used to connect soft, living muscle constructs with the semirigid components of soft robots to obtain a better mechanical advantage and deformation rate.

7.2. Operation Mode and Lifetime

The term compactness refers to how small we can manufacture an integrated platform. Soft robots' compactness determines their operation areas and modes, i.e., tethered or untethered. For example, most fluidic soft robots that have been developed for manipulation tasks are bulky and tethered because they require fluidic pressure for actuation. Commercial electronic components have already allowed researchers to manufacture untethered fluidic soft robots that can locomote both on land (149) and underwater (135). By contrast, soft robots that are powered with high-voltage electricity are mostly tethered and not compact due to the lack of small electronics that are necessary for high voltage generation. Fortunately, recent research efforts have focused on designing and manufacturing centimeter-scale, battery-powered high-voltage power suppliers that can enable the creation of untethered electrostatic soft robots (162). As a final example, even though biohybrid soft robots usually require an electrical input for actuation, recent biohybrid soft robots have been able to operate in an untethered fashion by using optogenetically engineered muscle cells that react to light stimulation (40, 59) or by integrating optogenetically engineered nerve cells that can control muscle contraction (64).

The operational lifetime is another important point that should be considered when fabricating soft robots. Soft robots that operate in an untethered fashion have a limited lifetime due to the power storage capacity of existing battery technologies. Therefore, alternative green energy sources, such as solar energy (163), should be considered when designing soft robots that will perform operations outside the laboratory in the future. In addition to powering limitations, soft robots are usually prone to being damaged and ruptured due to their soft materials' properties. For example, fluidic soft robots are no longer able to operate when a sharp or pointy object hits them. In addition, when the uncontrolled internal fluidic pressure increases, their soft bodies can rupture. In these cases, it would be advantageous for the robots to be built using self-healing elastic

materials as structural building elements because robots manufactured from such materials would be able to recover their functions and continue to operate (164, 165). As another example, most electrostatic soft robots stop working after several thousand cycles due to dielectric breakdown. The ones that operate with liquid dielectric materials can survive after many dielectric breakdowns due to the self-healing ability of liquid dielectric materials. For example, donut HASEL robots can operate for more than 1 million cycles while lifting a 150-g object at a 15% strain (24). Finally, most biohybrid robots lose their functionalities after a couple of days due to fatigue and cell damage, which results from an insufficient supply of nutrients and oxygen. However, the operational lifetime of these robots could be increased by integrating vessel-like structures into their designs to supply proper nutrients and oxygen. In addition, cells of nonmammalian origin that can survive under ambient room conditions without any carbon dioxide supply and are resistant to extreme environmental variations could potentially be used as actuators in soft robotics (66, 166).

7.3. Eco-Friendliness and Sustainability

Most existing soft robots have a negative impact on our ecosystem due to their building materials and power sources. In the future, new strategies should be developed to reduce the carbon footprint of soft robots in order to minimize their negative impact on the environment after disposal. Therefore, future soft robots should be sustainable. For example, they could be manufactured from recyclable plastic materials. In addition, biodegradable natural elastic materials could be used for fabrication, since these materials do not turn into environmentally toxic side products after degradation (161). Moreover, we should consider recycling electronic components, or we could fabricate robots that are able to operate without any electronics (141). In addition, we could use natural sources, such as solar energy (163) and fuel cells (153), to power our robots. Finally, we should consider silent actuation modalities, such as electrostatic and biohybrid ones, when designing soft robots for environmental operations. The constant noise of machines is a problem for living beings everywhere—both in the oceans and on land. For instance, humans who are constantly exposed to noise can become stressed or depressed or even develop tinnitus (167). In this regard, we should overhaul our approach to enhancing the eco-friendliness of future soft robots by considering their materials' properties and their often overlooked and fixable adverse effects while operating next to living beings.

DISCLOSURE STATEMENT

The authors are not aware of any affiliations, memberships, funding, or financial holdings that might be perceived as affecting the objectivity of this review.

AUTHOR CONTRIBUTIONS

R.K.K. and O.Y. conceived the original concept and manuscript outline, wrote the manuscript, generated figures, and edited the text. Y.T. contributed to Sections 4 and 5, generated figures, and edited the text. M.Y.M. contributed to Section 3, generated figures, and edited the text. L.S.J. contributed to Section 5.3. M.F. contributed to Section 2.5. T.B. contributed to Section 2.2.

LITERATURE CITED

1. Kim S, Laschi C, Trimmer B. 2013. Soft robotics: a bioinspired evolution in robotics. *Trends Biotechnol.* 31:287–94
2. Rus D, Tolley MT. 2015. Design, fabrication and control of soft robots. *Nature* 521:467–75
3. Majidi C. 2019. Soft-matter engineering for soft robotics. *Adv. Mater. Technol.* 4:1800477

4. Amend J, Cheng N, Fakhouri S, Culley B. 2016. Soft robotics commercialization: jamming grippers from research to product. *Soft Robot.* 3:213–22
5. Jørgensen TB, Jensen SHN, Aanæs H, Hansen NW, Krüger N. 2019. An adaptive robotic system for doing pick and place operations with deformable objects. *J. Intell. Robot. Syst.* 94:81–100
6. Wang Z, Kanegae R, Hirai S. 2021. Circular shell gripper for handling food products. *Soft Robot.* 8:542–54
7. Galloway KC, Becker KP, Phillips B, Kirby J, Licht S, et al. 2016. Soft robotic grippers for biological sampling on deep reefs. *Soft Robot.* 3:23–33
8. Kurumaya S, Phillips BT, Becker KP, Rosen MH, Gruber DF, et al. 2018. A modular soft robotic wrist for underwater manipulation. *Soft Robot.* 5:399–409
9. Vogt DM, Becker KP, Phillips BT, Graule MA, Rotjan RD, et al. 2018. Shipboard design and fabrication of custom 3D-printed soft robotic manipulators for the investigation of delicate deep-sea organisms. *PLOS ONE* 13:e0200386
10. Bernth JE, Arezzo A, Liu H. 2017. A novel robotic meshworm with segment-bending anchoring for colonoscopy. *IEEE Robot. Autom. Lett.* 2:1718–24
11. Abidi H, Gerboni G, Brancadoro M, Fras J, Diodato A, et al. 2018. Highly dexterous 2-module soft robot for intra-organ navigation in minimally invasive surgery. *Int. J. Med. Robot.* 14:e1875
12. Hu W, Lum GZ, Mastrangeli M, Sitti M. 2018. Small-scale soft-bodied robot with multimodal locomotion. *Nature* 554:81–85
13. Martinez RV, Branch JL, Fish CR, Jin L, Shepherd RF, et al. 2013. Robotic tentacles with three-dimensional mobility based on flexible elastomers. *Adv. Mater.* 25:205–12
14. Mosadegh B, Polygerinos P, Keplinger C, Wennstedt S, Shepherd RF, et al. 2014. Pneumatic networks for soft robotics that actuate rapidly. *Adv. Funct. Mater.* 24:2163–70
15. Onal CD, Rus D. 2013. Autonomous undulatory serpentine locomotion utilizing body dynamics of a fluidic soft robot. *Bioinspir. Biomim.* 8:026003
16. Marchese AD, Katzschmann RK, Rus D. 2015. A recipe for soft fluidic elastomer robots. *Soft Robot.* 2:7–25
17. Polygerinos P, Correll N, Morin SA, Mosadegh B, Onal CD, et al. 2017. Soft robotics: review of fluid-driven intrinsically soft devices; manufacturing, sensing, control, and applications in human-robot interaction. *Adv. Eng. Mater.* 19:1700016
18. Pelrine RE, Kornbluh RD, Joseph JP. 1998. Electrostriction of polymer dielectrics with compliant electrodes as a means of actuation. *Sens. Actuators A* 64:77–85
19. Perju E, Ko YS, Dünki SJ, Opris DM. 2020. Increased electromechanical sensitivity of polysiloxane elastomers by chemical modification with thioacetic groups. *Mater. Des.* 186:108319
20. Huang J, Lu T, Zhu J, Clarke DR, Suo Z. 2012. Large, uni-directional actuation in dielectric elastomers achieved by fiber stiffening. *Appl. Phys. Lett.* 100:211901
21. Gupta U, Qin L, Wang Y, Godaba H, Zhu J. 2019. Soft robots based on dielectric elastomer actuators: a review. *Smart Mater. Struct.* 28:103002
22. Youn JH, Jeong SM, Hwang G, Kim H, Hyeon K, et al. 2020. Dielectric elastomer actuator for soft robotics applications and challenges. *Appl. Sci.* 10:640
23. Iacob M, Verma A, Buchner T, Sheima Y, Katzschmann R, Opris DM. 2021. Slot-die coating of an on-the-shelf polymer with increased dielectric permittivity for stack actuators. *ACS Appl. Polym. Mater.* 4:150–57
24. Acome E, Mitchell SK, Morrissey T, Emmett M, Benjamin C, et al. 2018. Hydraulically amplified self-healing electrostatic actuators with muscle-like performance. *Science* 359:61–65
25. Rothmund P, Kellaris N, Mitchell SK, Acome E, Keplinger C. 2021. HASEL artificial muscles for a new generation of lifelike robots—recent progress and future opportunities. *Adv. Mater.* 33:2003375
26. Kellaris N, Gopaluni Venkata V, Smith GM, Mitchell SK, Keplinger C. 2018. Peano-HASEL actuators: muscle-mimetic, electrohydraulic transducers that linearly contract on activation. *Sci. Robot.* 3:eaar3276
27. Leroy E, Hinchet R, Shea H. 2020. Multimode hydraulically amplified electrostatic actuators for wearable haptics. *Adv. Mater.* 32:2002564
28. Helps T, Romero C, Taghavi M, Conn AT, Rossiter J. 2022. Liquid-amplified zipping actuators for micro-air vehicles with transmission-free flapping. *Sci. Robot.* 7:eabi8189

29. O'Neill MR, Acome E, Bakarich S, Mitchell SK, Timko J, et al. 2020. Rapid 3D printing of electrohydraulic (HASEL) tentacle actuators. *Adv. Funct. Mater.* 30:2005244
30. Wang J, Gao D, Lee PS. 2021. Recent progress in artificial muscles for interactive soft robotics. *Adv. Mater.* 33:2003088
31. Yang Y, Wu Y, Li C, Yang X, Chen W. 2020. Flexible actuators for soft robotics. *Adv. Intell. Syst.* 2:1900077
32. Lee SJ, Han MJ, Kim SJ, Jho JY, Lee HY, Kim YH. 2006. A new fabrication method for IPMC actuators and application to artificial fingers. *Smart Mater. Struct.* 15:1217
33. Mousavi MSS, Alaei A, Hasani M, Kolahdouz M, Manteghi F, Ataei F. 2018. Fabrication of ionic polymer metal composite for bio-actuation application: sputtering and electroless plating methods. *Mater. Res. Express* 6:035312
34. Cianchetti M. 2013. Fundamentals on the use of shape memory alloys in soft robotics. In *Interdisciplinary Mechatronics*, ed. MK Habib, JP Davim, pp. 227–54. Hoboken, NJ: Wiley
35. Laschi C, Cianchetti M, Mazzolai B, Margheri L, Follador M, Dario P. 2012. Soft robot arm inspired by the octopus. *Adv. Robot.* 26:709–27
36. Lin HT, Leisk GG, Trimmer B. 2011. GoQBot: a caterpillar-inspired soft-bodied rolling robot. *Bioinspir. Biomim.* 6:026007
37. Villanueva A, Smith C, Priya S. 2011. A biomimetic robotic jellyfish (Robojelly) actuated by shape memory alloy composite actuators. *Bioinspir. Biomim.* 6:036004
38. Kim HJ, Song SH, Ahn SH. 2012. A turtle-like swimming robot using a smart soft composite (SSC) structure. *Smart Mater. Struct.* 22:014007
39. Huang X, Kumar K, Jawed MK, Mohammadi Nasab A, Ye Z, et al. 2019. Highly dynamic shape memory alloy actuator for fast moving soft robots. *Adv. Mater. Technol.* 4:1800540
40. Abbott JJ, Diller E, Petruska AJ. 2020. Magnetic methods in robotics. *Annu. Rev. Control Robot. Auton. Syst.* 3:57–90
41. Kim Y, Parada GA, Liu S, Zhao X. 2019. Ferromagnetic soft continuum robots. *Sci. Robot.* 4:eaax7329
42. Kim Y, Zhao X. 2022. Magnetic soft materials and robots. *Chem. Rev.* 122:5317–64
43. Huang HW, Sakar MS, Petruska AJ, Pané S, Nelson BJ. 2016. Soft micromachines with programmable motility and morphology. *Nat. Commun.* 7:12263
44. Lum GZ, Ye Z, Dong X, Marvi H, Erin O, et al. 2016. Shape-programmable magnetic soft matter. *PNAS* 113:6007–15
45. Ren Z, Hu W, Dong X, Sitti M. 2019. Multi-functional soft-bodied jellyfish-like swimming. *Nat. Commun.* 10:2703
46. Kim Y, Yuk H, Zhao R, Chester SA, Zhao X. 2018. Printing ferromagnetic domains for untethered fast-transforming soft materials. *Nature* 558:274–79
47. Xu T, Zhang J, Salehizadeh M, Onaizah O, Diller E. 2019. Millimeter-scale flexible robots with programmable three-dimensional magnetization and motions. *Sci. Robot.* 4:eaav4494
48. Li M, Wang Y, Chen A, Naidu A, Napier BS, et al. 2018. Flexible magnetic composites for light-controlled actuation and interfaces. *PNAS* 115:8119–24
49. Alapan Y, Karacakol AC, Guzelhan SN, Isik I, Sitti M. 2020. Reprogrammable shape morphing of magnetic soft machines. *Sci. Adv.* 6:eabc6414
50. Ricotti L, Trimmer B, Feinberg AW, Raman R, Parker KK, et al. 2017. Biohybrid actuators for robotics: a review of devices actuated by living cells. *Sci. Robot.* 2:eaq0495
51. Mazzolai B, Laschi C. 2020. A vision for future bioinspired and biohybrid robots. *Sci. Robot.* 5:eaba6893
52. Trimmer BA. 2020. Metal or muscle? The future of biologically inspired robots. *Sci. Robot.* 5:eaba6149
53. Raman R, Grant L, Seo Y, Cvetkovic C, Gapinske M, et al. 2017. Damage, healing, and remodeling in optogenetic skeletal muscle bioactuators. *Adv. Healthc. Mater.* 6:1700030
54. Xi J, Schmidt JJ, Montemagno CD. 2005. Self-assembled microdevices driven by muscle. *Nat. Mater.* 4:180–84
55. Akiyama Y, Hoshino T, Iwabuchi K, Morishima K. 2012. Room temperature operable autonomously moving bio-microrobot powered by insect dorsal vessel tissue. *PLOS ONE* 7:e38274
56. Feinberg AW, Feigel A, Shevkoplyas SS, Sheehy S, Whitesides GM, Parker KK. 2007. Muscular thin films for building actuators and powering devices. *Science* 317:1366–70

57. Nawroth JC, Lee H, Feinberg AW, Ripplinger CM, McCain ML, et al. 2012. A tissue-engineered jellyfish with biomimetic propulsion. *Nat. Biotechnol.* 30:792–97
58. Williams BJ, Anand SV, Rajagopalan J, Saif MTA. 2014. A self-propelled biohybrid swimmer at low Reynolds number. *Nat. Commun.* 5:3081
59. Park SJ, Gazzola M, Park KS, Park S, Di Santo V, et al. 2016. Phototactic guidance of a tissue-engineered soft-robotic ray. *Science* 353:158–62
60. Lee KY, Park SJ, Matthews DG, Kim SL, Marquez CA, et al. 2022. An autonomously swimming biohybrid fish designed with human cardiac biophysics. *Science* 375:639–47
61. Cvetkovic C, Raman R, Chan V, Williams BJ, Tolish M, et al. 2014. Three-dimensionally printed biological machines powered by skeletal muscle. *PNAS* 111:10125–30
62. Guix M, Mestre R, Patiño T, De Corato M, Fuentes J, et al. 2021. Biohybrid soft robots with self-stimulating skeletons. *Sci. Robot.* 6:eabe7577
63. Raman R, Cvetkovic C, Uzel SG, Platt RJ, Sengupta P, et al. 2016. Optogenetic skeletal muscle-powered adaptive biological machines. *PNAS* 113:3497–502
64. Aydin O, Zhang X, Nuethong S, Pagan-Diaz GJ, Bashir R, et al. 2019. Neuromuscular actuation of biohybrid motile bots. *PNAS* 116:19841–47
65. Herr H, Dennis RG. 2004. A swimming robot actuated by living muscle tissue. *J. NeuroEng. Rehabil.* 1:6
66. Uesugi K, Shimizu K, Akiyama Y, Hoshino T, Iwabuchi K, Morishima K. 2016. Contractile performance and controllability of insect muscle-powered bioactuator with different stimulation strategies for soft robotics. *Soft Robot.* 3:13–22
67. Baryshyan A, Domigan L, Hunt B, Trimmer B, Kaplan D. 2014. Self-assembled insect muscle bioactuators with long term function under a range of environmental conditions. *RSC Adv.* 4:39962–68
68. Katzschmann RK, Thieffry M, Goury O, Kruszewski A, Guerra TM, et al. 2019. Dynamically closed-loop controlled soft robotic arm using a reduced order finite element model with state observer. In *2019 2nd IEEE International Conference on Soft Robotics (RoboSoft)*, pp. 717–24. Piscataway, NJ: IEEE
69. Doroudchi A, Berman S. 2021. Configuration tracking for soft continuum robotic arms using inverse dynamic control of a Cosserat rod model. In *2019 2nd IEEE International Conference on Soft Robotics (RoboSoft)*, pp. 207–14. Piscataway, NJ: IEEE
70. Katzschmann RK, Della Santina C, Toshimitsu Y, Bicchi A, Rus D. 2019. Dynamic motion control of multi-segment soft robots using piecewise constant curvature matched with an augmented rigid body model. In *2019 2nd IEEE International Conference on Soft Robotics (RoboSoft)*, pp. 454–61. Piscataway, NJ: IEEE
71. Coevoet E, Morales-Bieze T, Largilliere F, Zhang Z, Thieffry M, et al. 2017. Software toolkit for modeling, simulation, and control of soft robots. *Adv. Robot.* 31:1208–24
72. Du T, Wu K, Ma P, Wah S, Spielberg A, et al. 2021. DiffPD: Differentiable Projective Dynamics. *ACM Trans. Graph.* 41:13
73. Li M, Ferguson Z, Schneider T, Langlois TR, Zorin D, et al. 2020. Incremental potential contact: intersection- and inversion-free, large-deformation dynamics. *ACM Trans. Graph.* 39:49
74. Hu Y, Liu J, Spielberg A, Tenenbaum JB, Freeman WT, et al. 2019. ChainQueen: a real-time differentiable physical simulator for soft robotics. In *2019 International Conference on Robotics and Automation (ICRA)*, pp. 6265–71. Piscataway, NJ: IEEE
75. Allard J, Cotin S, Faure F, Bensoussan PJ, Poyer F, et al. 2007. SOFA—an open source framework for medical simulation. In *Medicine Meets Virtual Reality 15*, ed. JD Westwood, RS Haluck, HM Hoffman, GT Mogel, R Phillips, et al., pp. 13–18. Amsterdam: IOS
76. Goury O, Carrez B, Duriez C. 2021. Real-time simulation for control of soft robots with self-collisions using model order reduction for contact forces. *IEEE Robot. Autom. Lett.* 6:3752–59
77. COMSOL. 2021. COMSOL Multiphysics® simulation software. *COMSOL*. <https://www.comsol.com/comsol-multiphysics>
78. Smith M. 2009. *ABAQUS/Standard User's Manual, Version 6.9*. Johnston, RI: Dassault Syst. Simulia
79. Verschoor M, Jalba AC. 2019. Efficient and accurate collision response for elastically deformable models. *ACM Trans. Graph.* 38:17
80. Ma P, Du T, Zhang JZ, Wu K, Spielberg A, et al. 2021. DiffAqua: a differentiable computational design pipeline for soft underwater swimmers with shape interpolation. *ACM Trans. Graph.* 40:132

81. Nava E, Zhang JZ, Michelis MY, Du T, Ma P, et al. 2022. Fast aquatic swimmer optimization with differentiable projective dynamics and neural network hydrodynamic models. In *Proceedings of the 39th International Conference on Machine Learning*, ed. K Chaudhuri, S Jegelka, L Song, C Szepesvari, G Niu, S Sabato, pp. 16413–27. Proc. Mach. Learn. Res. 162. N.p.: PMLR
82. Zhang JZ, Zhang Y, Ma P, Nava E, Du T, et al. 2021. Learning material parameters and hydrodynamics of soft robotic fish via differentiable simulation. arXiv:2109.14855 [cs.RO]
83. Dubied M, Michelis MY, Spielberg A, Katzschmann RK. 2022. Sim-to-real for soft robots using differentiable FEM: recipes for meshing, damping, and actuation. *IEEE Robot. Autom. Lett.* 7:5015–22
84. Naughton N, Sun J, Tekinalp A, Parthasarathy T, Chowdhary G, Gazzola M. 2021. Elastica: a compliant mechanics environment for soft robotic control. *IEEE Robot. Autom. Lett.* 6:3389–96
85. Renda F, Boyer F, Dias J, Seneviratne L. 2018. Discrete Cosserat approach for multisection soft manipulator dynamics. *IEEE Trans. Robot.* 34:1518–33
86. Till J, Aloï V, Rucker C. 2019. Real-time dynamics of soft and continuum robots based on Cosserat rod models. *Int. J. Robot. Res.* 38:723–46
87. Grazioso S, Di Gironimo G, Siciliano B. 2019. A geometrically exact model for soft continuum robots: the finite element deformation space formulation. *Soft Robot.* 6:790–811
88. Della Santina C, Bicchi A, Rus D. 2020. On an improved state parametrization for soft robots with piecewise constant curvature and its use in model based control. *IEEE Robot. Autom. Lett.* 5:1001–8
89. Della Santina C, Katzschmann RK, Bicchi A, Rus D. 2018. Dynamic control of soft robots interacting with the environment. In *2018 IEEE International Conference on Soft Robotics (RoboSoft)*, pp. 46–53. Piscataway, NJ: IEEE
90. Della Santina C, Katzschmann RK, Bicchi A, Rus D. 2020. Model-based dynamic feedback control of a planar soft robot: trajectory tracking and interaction with the environment. *Int. J. Robot. Res.* 39:490–513
91. Toshimitsu Y, Wong KW, Buchner T, Katzschmann R. 2021. SoPrA: fabrication & dynamical modeling of a scalable soft continuum robotic arm with integrated proprioceptive sensing. In *2021 IEEE/RSJ International Conference on Intelligent Robots and Systems (IROS)*, pp. 653–60. Piscataway, NJ: IEEE
92. Huang X, Zou J, Gu G. 2021. Kinematic modeling and control of variable curvature soft continuum robots. *IEEE/ASME Trans. Mechatron.* 26:3175–85
93. Della Santina C, Rus D. 2019. Control oriented modeling of soft robots: the polynomial curvature case. *IEEE Robot. Autom. Lett.* 5:290–98
94. Singh I, Amara Y, Melingui A, Mani Pathak P, Merzouki R. 2018. Modeling of continuum manipulators using Pythagorean hodograph curves. *Soft Robot.* 5:425–42
95. Kazemipour A, Fischer O, Toshimitsu Y, Wong KW, Katzschmann RK. 2022. Adaptive dynamic sliding mode control of soft continuum manipulators. In *2022 International Conference on Robotics and Automation (ICRA)*, pp. 3259–65. Piscataway, NJ: IEEE
96. Thuruthel TG, Falotico E, Renda F, Laschi C. 2019. Model-based reinforcement learning for closed-loop dynamic control of soft robotic manipulators. *IEEE Trans. Robot.* 35:124–34
97. Gillespie MT, Best CM, Townsend EC, Wingate D, Killpack MD. 2018. Learning nonlinear dynamic models of soft robots for model predictive control with neural networks. In *2018 IEEE International Conference on Soft Robotics (RoboSoft)*, pp. 39–45. Piscataway, NJ: IEEE
98. Pfaff T, Fortunato M, Sanchez-Gonzalez A, Battaglia P. 2021. Learning mesh-based simulation with graph networks. In *2021 International Conference on Learning Representations*. La Jolla, CA: Int. Conf. Learn. Represent. https://openreview.net/pdf?id=roNqYL0_XP
99. Soter G, Conn A, Hauser H, Rossiter J. 2018. Bodily aware soft robots: integration of proprioceptive and exteroceptive sensors. In *2018 IEEE International Conference on Robotics and Automation (ICRA)*, pp. 2448–53. Piscataway, NJ: IEEE
100. Bruder D, Fu X, Gillespie RB, Remy CD, Vasudevan R. 2020. Data-driven control of soft robots using Koopman operator theory. *IEEE Trans. Robot.* 37:948–61
101. Han M, Euler-Rolle J, Katzschmann RK. 2022. DeSKO: stability-assured robust control with a deep stochastic Koopman operator. In *2022 International Conference on Learning Representations*. La Jolla, CA: Int. Conf. Learn. Represent. https://openreview.net/pdf?id=hniLRD_XCA

102. Kim JI, Hong M, Lee K, Kim D, Park YL, Oh S. 2020. Learning to walk a tripod mobile robot using nonlinear soft vibration actuators with entropy adaptive reinforcement learning. *IEEE Robot. Autom. Lett.* 5:2317–24
103. Zhang B, Liu P. 2021. Model-based and model-free robot control: a review. In *RiTA 2020: Proceedings of the 8th International Conference on Robot Intelligence Technology and Applications*, ed. E Chew, APPA Majeed, P Liu, J Platts, H Myung, et al., pp. 45–55. Singapore: Springer
104. Caasenbrood BJ, Pogromsky AY, Nijmeijer H. 2020. Dynamic modeling of hyper-elastic soft robots using spatial curves. *IFAC-PapersOnLine* 53(2):9238–43
105. Jiang H, Wang Z, Jin Y, Chen X, Li P, et al. 2021. Hierarchical control of soft manipulators towards unstructured interactions. *Int. J. Robot. Res.* 40:411–34
106. Garriga-Casanovas A, Rodriguez y Baena F. 2019. Kinematics of continuum robots with constant curvature bending and extension capabilities. *J. Mech. Robot.* 11:011010
107. Della Santina C, Pallottino L, Rus D, Bicchi A. 2019. Exact task execution in highly under-actuated soft limbs: an operational space based approach. *IEEE Robot. Autom. Lett.* 4:2508–15
108. Wang H, Yang B, Liu Y, Chen W, Liang X, Pfeifer R. 2016. Visual servoing of soft robot manipulator in constrained environments with an adaptive controller. *IEEE/ASME Trans. Mechatron.* 22:41–50
109. Fischer O, Toshimitsu Y, Kazempour A, Katzschmann RK. 2023. Dynamic task space control enables soft manipulators to perform real-world tasks. *Adv. Intell. Syst.* 5:2200024
110. Trumić M, Della Santina C, Jovanović K, Fagiolini A. 2021. Adaptive control of soft robots based on an enhanced 3D augmented rigid robot matching. In *2021 American Control Conference (ACC)*, pp. 4991–96. Piscataway, NJ: IEEE
111. Verghese M, Richter F, Gunn A, Weissbrod P, Yip M. 2022. Model-free visual control for continuum robot manipulators via orientation adaptation. In *Robotics Research: The 19th International Symposium ISRR*, ed. T Asfour, E Yoshida, J Park, H Christensen, O Khatib, pp. 959–70. Cham, Switz.: Springer
112. Satheshbabu S, Uppalapati NK, Chowdhary G, Krishnan G. 2019. Open loop position control of soft continuum arm using deep reinforcement learning. In *2019 International Conference on Robotics and Automation (ICRA)*, pp. 5133–39. Piscataway, NJ: IEEE
113. Navarro SE, Nagels S, Alagi H, Faller LM, Goury O, et al. 2020. A model-based sensor fusion approach for force and shape estimation in soft robotics. *IEEE Robot. Autom. Lett.* 5:5621–28
114. Homberg BS, Katzschmann RK, Dogar MR, Rus D. 2019. Robust proprioceptive grasping with a soft robot hand. *Auton. Robots* 43:681–96
115. Teyssier M, Parilusyan B, Roudaut A, Steimle J. 2021. Human-like artificial skin sensor for physical human-robot interaction. In *2021 IEEE International Conference on Robotics and Automation (ICRA)*, pp. 3626–33. Piscataway, NJ: IEEE
116. Mirzanejad H, Agheli M. 2019. Soft force sensor made of magnetic powder blended with silicone rubber. *Sens. Actuators A* 293:108–18
117. Kuppuswamy N, Alspach A, Uttamchandani A, Creasey S, Ikeda T, Tedrake R. 2020. Soft-bubble grippers for robust and perceptive manipulation. In *2020 IEEE/RSJ International Conference on Intelligent Robots and Systems (IROS)*, pp. 9917–24. Piscataway, NJ: IEEE
118. Shih B, Christianson C, Gillespie K, Lee S, Mayeda J, et al. 2019. Design considerations for 3D printed, soft, multimaterial resistive sensors for soft robotics. *Front. Robot. AI* 6:30
119. Ozel S, Skorina EH, Luo M, Tao W, Chen F, et al. 2016. A composite soft bending actuation module with integrated curvature sensing. In *2016 IEEE International Conference on Robotics and Automation (ICRA)*, pp. 4963–68. Piscataway, NJ: IEEE
120. Nguyen PH, Sridar S, Zhang W, Polygerinos P. 2017. Design and control of a 3-chambered fiber reinforced soft actuator with off-the-shelf stretch sensors. *Int. J. Intell. Robot. Appl.* 1:342–51
121. Georgopoulou A, Clemens F. 2022. Pellet-based fused deposition modeling for the development of soft compliant robotic grippers with integrated sensing elements. *Flex. Print. Electron.* 7:025010
122. Truby RL, Della Santina C, Rus D. 2020. Distributed proprioception of 3D configuration in soft, sensorized robots via deep learning. *IEEE Robot. Autom. Lett.* 5:3299–306
123. Tapia J, Knoop E, Muth M, Otaduy MA, Bächer M. 2020. MakeSense: automated sensor design for proprioceptive soft robots. *Soft Robot.* 7:332–45

124. Chossat JB, Park YL, Wood RJ, Duchaine V. 2013. A soft strain sensor based on ionic and metal liquids. *IEEE Sens. J.* 13:3405–14
125. Truby RL, Wehner M, Grosskopf AK, Vogt DM, Uzel SG, et al. 2018. Soft somatosensitive actuators via embedded 3D printing. *Adv. Mater.* 30:1706383
126. Wang H, Zhang R, Chen W, Liang X, Pfeifer R. 2016. Shape detection algorithm for soft manipulator based on fiber Bragg gratings. *IEEE/ASME Trans. Mechatron.* 21:2977–82
127. Zhang Z, Wang X, Wang S, Meng D, Liang B. 2018. Shape detection and reconstruction of soft robotic arm based on fiber Bragg grating sensor array. In *2018 IEEE International Conference on Robotics and Biomimetics (ROBIO)*, pp. 978–83. Piscataway, NJ: IEEE
128. Sefati S, Murphy RJ, Alambeigi F, Pozin M, Iordachita I, et al. 2018. FBG-based control of a continuum manipulator interacting with obstacles. In *2018 IEEE/RSJ International Conference on Intelligent Robots and Systems (IROS)*, pp. 6477–83. Piscataway, NJ: IEEE
129. Zhuang W, Sun G, Li H, Lou X, Dong M, Zhu L. 2018. FBG based shape sensing of a silicone octopus tentacle model for soft robotics. *Optik* 165:7–15
130. Monet F, Sefati S, Lorre P, Poiffaut A, Kadoury S, et al. 2020. High-resolution optical fiber shape sensing of continuum robots: a comparative study. In *2020 IEEE International Conference on Robotics and Automation (ICRA)*, pp. 8877–83. Piscataway, NJ: IEEE
131. Walck G, Perdereau V. 2014. Software compensation of magnetic crosstalk on Hall-effect-based rotary encoders close together. In *2014 IEEE International Conference on Robotics and Automation (ICRA)*, pp. 4906–11. Piscataway, NJ: IEEE
132. Khaykin Y, Oosthuizen R, Zarnett L, Wulffhart ZA, Whaley B, et al. 2011. CARTO-guided vs. NavX-guided pulmonary vein antrum isolation and pulmonary vein antrum isolation performed without 3-D mapping: effect of the 3-D mapping system on procedure duration and fluoroscopy time. *J. Interv. Card. Electrophysiol.* 30:233–40
133. Khaykin Y, Zarnett L, Friedlander D, Wulffhart ZA, Whaley B, et al. 2012. Point-by-point pulmonary vein antrum isolation guided by intracardiac echocardiography and 3D mapping and duty-cycled multipolar AF ablation: effect of multipolar ablation on procedure duration and fluoroscopy time. *J. Interv. Card. Electrophysiol.* 34:303–10
134. der Maur PA, Djambazi B, Haberthür Y, Hörmann P, Kübler A, et al. 2021. RoBoa: construction and evaluation of a steerable vine robot for search and rescue applications. In *2021 IEEE International Conference on Soft Robotics (RoboSoft)*, pp. 15–20. Piscataway, NJ: IEEE
135. Katzschmann RK, DelPreto J, MacCurdy R, Rus D. 2018. Exploration of underwater life with an acoustically controlled soft robotic fish. *Sci. Robot.* 3:eaar3449
136. Brown E, Rodenberg N, Amend J, Mozeika A, Steltz E, et al. 2010. Universal robotic gripper based on the jamming of granular material. *PNAS* 107:18809–14
137. Gorissen B, De Volder M, Reynaerts D. 2018. Chip-on-tip endoscope incorporating a soft robotic pneumatic bending microactuator. *Biomed. Microdevices* 20:73
138. Shintake J, Caccuciolo V, Floreano D, Shea H. 2018. Soft robotic grippers. *Adv. Mater.* 30:1707035
139. Shintake J, Rosset S, Schubert B, Floreano D, Shea H. 2016. Versatile soft grippers with intrinsic electroadhesion based on multifunctional polymer actuators. *Adv. Mater.* 28:231–38
140. Zhang YF, Zhang N, Hingorani H, Ding N, Wang D, et al. 2019. Fast-response, stiffness-tunable soft actuator by hybrid multimaterial 3D printing. *Adv. Funct. Mater.* 29:1806698
141. Drotman D, Jadhav S, Sharp D, Chan C, Tolley MT. 2021. Electronics-free pneumatic circuits for controlling soft-legged robots. *Sci. Robot.* 6:eaay2627
142. Chautems C, Tonazzini A, Boehler Q, Jeong SH, Floreano D, Nelson BJ. 2020. Magnetic continuum device with variable stiffness for minimally invasive surgery. *Adv. Intell. Syst.* 2:1900086
143. Gu G, Zhang N, Xu H, Lin S, Yu Y, et al. 2021. A soft neuroprosthetic hand providing simultaneous myoelectric control and tactile feedback. *Nat. Biomed. Eng.* <https://doi.org/10.1038/s41551-021-00767-0>
144. Fusco S, Sakar MS, Kennedy S, Peters C, Bottani R, et al. 2014. An integrated microrobotic platform for on-demand, targeted therapeutic interventions. *Adv. Mater.* 26:952–57
145. Morimoto Y, Onoe H, Takeuchi S. 2018. Biohybrid robot powered by an antagonistic pair of skeletal muscle tissues. *Sci. Robot.* 3:eaat4440

146. Song S, Sitti M. 2014. Soft grippers using micro-fibrillar adhesives for transfer printing. *Adv. Mater.* 26:4901–6
147. Morin SA, Shepherd RF, Kwok SW, Stokes AA, Nemiroski A, Whitesides GM. 2012. Camouflage and display for soft machines. *Science* 337:828–32
148. Won P, Kim KK, Kim H, Park JJ, Ha I, et al. 2021. Transparent soft actuators/sensors and camouflage skins for imperceptible soft robotics. *Adv. Mater.* 33:2002397
149. Tolley MT, Shepherd RF, Galloway KC, Wood RJ, Whitesides GM, et al. 2014. A resilient, untethered soft robot. *Soft Robot.* 1:213–23
150. Li T, Li G, Liang Y, Cheng T, Dai J, et al. 2017. Fast-moving soft electronic fish. *Sci. Adv.* 3:e1602045
151. Li G, Chen X, Zhou F, Liang Y, Xiao Y, et al. 2021. Self-powered soft robot in the Mariana Trench. *Nature* 591:66–71
152. Wehner M, Truby RL, Fitzgerald DJ, Mosadegh B, Whitesides GM, et al. 2016. An integrated design and fabrication strategy for entirely soft, autonomous robots. *Nature* 536:451–55
153. Aubin CA, Choudhury S, Jerch R, Archer LA, Pikul JH, Shepherd RF. 2019. Electrolytic vascular systems for energy-dense robots. *Nature* 571:51–57
154. Ranzani T, Cianchetti M, Gerboni G, De Falco I, Menciassi A. 2016. A soft modular manipulator for minimally invasive surgery: design and characterization of a single module. *IEEE Trans. Robot.* 32:187–200
155. Lussi J, Mattmann M, Sevim S, Grigis F, De Marco C, et al. 2021. A submillimeter continuous variable stiffness catheter for compliance control. *Adv. Sci.* 8:2101290
156. Kobayashi T, Matsunaga T, Haga Y. 2016. Active bending electric endoscope using shape memory alloy wires. In *New Trends in Medical and Service Robots*, ed. H Bleuler, M Bouri, F Mondada, D Pislá, A Rodic, P Helmer, pp. 131–39. Cham, Switz.: Springer
157. Mair LO, Adam G, Chowdhury S, Davis A, Arifin DR, et al. 2021. Soft capsule magnetic millirobots for region-specific drug delivery in the central nervous system. *Front. Robot. AI* 26:226
158. Hawkes EW, Majidi C, Tolley MT. 2021. Hard questions for soft robotics. *Sci. Robot.* 6:eabg6049
159. Rothemund P, Kim Y, Heisser RH, Zhao X, Shepherd RF, Keplinger C. 2021. Shaping the future of robotics through materials innovation. *Nat. Mater.* 20:1582–87
160. Terryn S, Langenbach J, Roels E, Brancart J, Bakkali-Hassani C, et al. 2021. A review on self-healing polymers for soft robotics. *Mater. Today* 47:187–205
161. Hartmann F, Baumgartner M, Kaltenbrunner M. 2021. Becoming sustainable, the new frontier in soft robotics. *Adv. Mater.* 33:2004413
162. Mitchell SK, Martin T, Keplinger C. 2022. A pocket-sized ten-channel high voltage power supply for soft electrostatic actuators. *Adv. Mater. Technol.* 7:2101469
163. Mirvakili SM, Leroy A, Sim D, Wang EN. 2021. Solar-driven soft robots. *Adv. Sci.* 8:2004235
164. Terryn S, Brancart J, Lefeber D, Van Assche G, Vanderborght B. 2017. Self-healing soft pneumatic robots. *Sci. Robot.* 2:eaan4268
165. Pena-Francesch A, Jung H, Demirel MC, Sitti M. 2020. Biosynthetic self-healing materials for soft machines. *Nat. Mater.* 19:1230–35
166. Dong X, Kheiri S, Lu Y, Xu Z, Zhen M, Liu X. 2021. Toward a living soft microrobot through optogenetic locomotion control of *Caenorhabditis elegans*. *Sci. Robot.* 6:eabe3950
167. Rauschecker JP, Leaver AM, Mühlau M. 2010. Tuning out the noise: limbic-auditory interactions in tinnitus. *Neuron* 66:819–26



Contents

An Overview of Soft Robotics <i>Oncay Yasa, Yasunori Toshimitsu, Mike Y. Michelis, Lewis S. Jones, Miriam Filippi, Thomas Buchner, and Robert K. Katzschmann</i>	1
Soft Actuators and Robots Enabled by Additive Manufacturing <i>Dong Wang, Jinqiang Wang, Zequn Shen, Chengru Jiang, Jiang Zou, Le Dong, Nicholas X. Fang, and Guoying Gu</i>	31
Adaptive Control and Intersections with Reinforcement Learning <i>Anuradha M. Annaswamy</i>	65
On the Timescales of Embodied Intelligence for Autonomous Adaptive Systems <i>Fumiya Iida and Fabio Giardina</i>	95
Toward a Theoretical Foundation of Policy Optimization for Learning Control Policies <i>Bin Hu, Kaiqing Zhang, Na Li, Mebran Mesbahi, Maryam Fazel, and Tamer Başar</i>	123
Sequential Monte Carlo: A Unified Review <i>Adrian G. Wills and Thomas B. Schön</i>	159
Construction Robotics: From Automation to Collaboration <i>Stefana Parascho</i>	183
Embodied Communication: How Robots and People Communicate Through Physical Interaction <i>Aleksandra Kalinowska, Patrick M. Pilarski, and Todd D. Murphey</i>	205
The Many Facets of Information in Networked Estimation and Control <i>Massimo Franceschetti, Mohammad Javad Khojasteh, and Moe Z. Win</i>	233
Crowd Dynamics: Modeling and Control of Multiagent Systems <i>Xiaoqian Gong, Michael Herty, Benedetto Piccoli, and Giuseppe Visconti</i>	261
Noise in Biomolecular Systems: Modeling, Analysis, and Control Implications <i>Corentin Briat and Mustafa Khammash</i>	283

Exploiting Liquid Surface Tension in Microrobotics <i>Antoine Barbot, Francisco Ortiz, Aude Bolepion, Michaël Gauthier, and Pierre Lambert</i>	313
Spacecraft-Mounted Robotics <i>Panagiotis Tsiotras, Matthew King-Smith, and Lorenzo Ticozzi</i>	335
Grasp Learning: Models, Methods, and Performance <i>Robert Platt</i>	363
Control of Multicarrier Energy Systems from Buildings to Networks <i>Roy S. Smith, Varscha Behrunani, and John Lygeros</i>	391
Control of Low-Inertia Power Systems <i>Florian Dörfler and Dominic Groß</i>	415
How the CYBATHLON Competition Has Advanced Assistive Technologies <i>Lukas Jaeger, Roberto de Souza Baptista, Chiara Basla, Patricia Capsi-Morales, Yong Kuk Kim, Shuro Nakajima, Cristina Piazza, Michael Sommerhalder, Luca Tonin, Giacomo Valle, Robert Riener, and Roland Sigrüst</i>	447
Into the Robotic Depths: Analysis and Insights from the DARPA Subterranean Challenge <i>Timothy H. Chung, Viktor Orekhov, and Angela Maio</i>	477

Errata

An online log of corrections to *Annual Review of Control, Robotics, and Autonomous Systems* articles may be found at <http://www.annualreviews.org/errata/control>